

High Power Low Cost Inductors

Model HM53

Features and Benefits

- Insulation Resistance, Minimum 100 MΩ
- Operating Temperature Range -40°C to +125°C
- Ambient Temperature, Maximum 85°C
- Temperature Rise, Maximum 40°C
- Operating Frequency Up to 400kHz
- RoHS Compliant

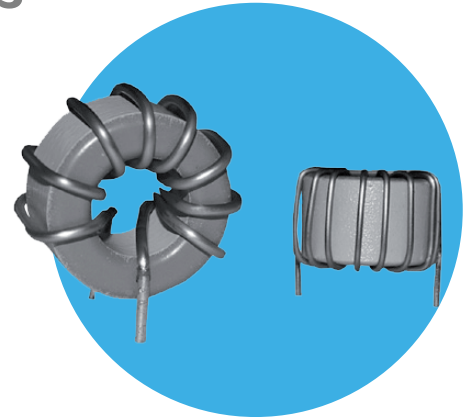

Specifications @ 25°C / Packaging

Part Number	Inductance ⁽¹⁾ Control Value μH ±20%	Rated ⁽²⁾ Inductance μH Typ.	Rated Current Adc	DCR mΩ Max.	Dimensions (mm) L / W / Ht		Quantity Per Carton (Units)	
					Vert. Mount	Hor. Mount	Vert. Mount	Hor. Mount
HM53-0008VLF	1.23	0.8	15.0	2.5	14.0 / 8.5 / 14.0	-	660	-
HM53-001R1_LF V or H	1.44	1.1	14.0	3.0	23.0 / 14.0 / 23.0	23.0 / 23.0 / 14.0	360	300
HM53-001R6_LF V or H	1.72	1.6	8.0	4.0	16.0 / 11.0 / 16.0	16.0 / 16.0 / 11.0	560	500
HM53-001R8_LF V or H	2.6	1.8	15.0	3.5	23.0 / 14.0 / 23.0	23.0 / 23.0 / 14.0	360	180
HM53-001R9_LF V or H	2.7	1.9	10.0	5.1	17.5 / 11.4 / 17.5	17.5 / 17.5 / 11.4	660	500
HM53-002R0_LF V or H	2.8	2.0	8.5	4.8	16.0 / 9.0 / 16.0	16.0 / 16.0 / 9.0	560	500
HM53-003R0_LF V or H	4.4	3.1	13.5	4.5	24.5 / 14.0 / 24.5	24.5 / 24.5 / 14.0	360	320
HM53-005R5_LF V or H	7.9	5.5	8.5	8.9	20.5 / 13.0 / 20.5	20.5 / 20.5 / 13.0	360	180
HM53-007R8_LF V or H	11.1	7.8	5.7	12.9	17.0 / 13.5 / 17.0	17.0 / 17.0 / 13.5	450	500
HM53-009R5_LF V or H	13.5	9.5	9.0	8.1	23.0 / 19.0 / 23.0	23.0 / 23.0 / 19.0	180	210
HM53-101R5VLF	2.7	1.5	15.0	3.3	18.0 / 10.0 / 18.0	-	560	-
HM53-101R6VLF	4.0	1.6	21.0	6.5	17.0 / 9.0 / 17.0	-	560	-
HM53-103R3VLF	4.0	3.3	10.0	10.0	15.0 / 8.0 / 15.0	-	560	-
HM53-108R0_LF V or H	10.1	8.0	3.0	10.5	16.2 / 8.5 / 16.2	16.2 / 16.2 / 8.5	660	500
HM53-10180_LF V or H	25.3	17.9	2.0	20.5	16.2 / 8.0 / 16.2	16.2 / 16.2 / 8.0	500	500
HM53-10320_LF V or H	50.3	32.3	2.6	59.1	16.2 / 9.0 / 16.2	16.2 / 16.2 / 9.0	560	500
HM53-10650_LF V or H	104.0	65.2	2.4	108.6	15.5 / 12.4 / 15.5	15.5 / 15.5 / 12.4	560	250
HM53-10101VLF	121.0	100.0	5.0	67.0	27.0 / 16.5 / 27.0	-	240	-
HM53-10111_LF V or H	151.7	106.4	2.3	165.9	20.7 / 9.4 / 20.7	20.7 / 20.7 / 9.4	360	300
HM53-10171_LF V or H	250.9	175.2	2.2	224.2	20.9 / 13.0 / 20.9	20.9 / 20.9 / 13.0	360	210
HM53-10351_LF V or H	505.0	354.3	1.9	375.1	24.0 / 15.3 / 24.0	24.0 / 24.0 / 15.3	180	140
HM53-10531_LF V or H	754.4	529.2	2.4	468.1	29.8 / 17.4 / 29.8	29.8 / 29.8 / 17.4	90	90
HM53-10701_LF V or H	1000.4	701.4	2.1	679.4	29.8 / 17.1 / 29.8	29.8 / 29.8 / 17.1	90	90
HM53-208R0_LF V or H	10.6	8.0	6.0	8.3	22.0 / 9.5 / 22.0	22.0 / 22.0 / 9.5	360	300
HM53-20190_LF V or H	25.0	19.1	4.0	20.3	22.0 / 9.0 / 22.0	22.0 / 22.0 / 9.0	360	300
HM53-20350_LF V or H	50.0	35.0	4.9	29.1	21.6 / 13.6 / 21.6	21.6 / 21.6 / 13.6	360	320
HM53-20580_LF V or H	73.9	58.1	2.5	59.9	22.0 / 9.0 / 22.0	22.0 / 22.0 / 9.0	360	300
HM53-20710_LF V or H	101.7	70.8	4.3	48.5	24.0 / 16.6 / 24.0	24.0 / 24.0 / 16.6	200	140
HM53-20101_LF V or H	148.0	103.6	4.0	70.5	30.6 / 11.4 / 30.6	30.6 / 30.6 / 11.4	90	135
HM53-20171_LF V or H	251.1	175.4	4.2	96.0	31.2 / 19.0 / 31.2	31.2 / 31.2 / 19.0	90	90
HM53-20351_LF V or H	499.4	349.0	3.3	183.0	36.7 / 14.8 / 36.7	36.7 / 36.7 / 14.8	45	75
HM53-20521_LF V or H	749.3	521.9	3.4	225.4	43.3 / 18.2 / 43.3	43.3 / 43.3 / 18.2	45	90
HM53-306R8_LF V or H	9.7	6.8	11.1	8.3	22.2 / 13.9 / 22.2	22.2 / 22.2 / 13.9	180	210
HM53-30150_LF V or H	21.3	14.9	9.3	17.8	24.5 / 16.6 / 24.5	24.5 / 24.5 / 16.6	200	140
HM53-30350_LF V or H	49.6	34.9	9.4	21.9	32.3 / 18.9 / 32.3	32.3 / 32.3 / 18.9	90	90
HM53-30580_LF V or H	78.0	58.5	4.0	40.9	30.0 / 13.0 / 30.0	30.0 / 30.0 / 13.0	200	140
HM53-30690_LF V or H	97.2	67.9	7.5	31.0	37.8 / 16.8 / 37.8	37.8 / 37.8 / 16.8	45	75
HM53-30101_LF V or H	150.6	105.4	7.5	45.6	46.4 / 19.8 / 46.4	46.4 / 46.4 / 19.8	45	90
HM53-30181_LF V or H	254.4	178.2	8.1	48.2	53.7 / 24.3 / 53.7	53.7 / 53.7 / 24.3	45	45
HM53-407R0_LF V or H	10.0	7.0	13.5	7.9	25.7 / 18.0 / 25.7	25.7 / 25.7 / 18.0	45	90
HM53-40150_LF V or H	21.0	14.7	14.5	11.5	32.4 / 19.8 / 32.4	32.4 / 32.4 / 19.8	90	90
HM53-40360_LF V or H	52.3	36.5	10.2	18.3	39.0 / 16.8 / 39.0	39.0 / 39.0 / 16.8	45	75
HM53-40550_LF V or H	74.5	54.8	6.0	26.1	35.0 / 16.0 / 35.0	35.0 / 35.0 / 16.0	90	90
HM53-40710_LF V or H	101.4	71.1	9.1	21.2	48.5 / 21.8 / 48.5	48.5 / 48.5 / 21.8	45	45

General Note

TT Electronics reserves the right to make changes in product specification without notice or liability.
All information is subject to TT Electronics' own data and is considered accurate at time of going to print.

Model HM53

Specification @ 25°C / Packaging (Cont'd)

Part Number	Inductance ⁽¹⁾ Control Value μH ±20%	Rated ⁽²⁾ Inductance μH Typ.	Rated Current A dc	DCR mΩ Max.	Dimensions (mm) L / W / Ht		Quantity Per Carton (Units)	
					Vert. Mount	Hor. Mount	Vert. Mount	Hor. Mount
HM53-40111_LF V or H	152.8	106.8	10.5	29.8	54.5 / 25.4 / 54.5	54.5 / 54.5 / 25.4	45	45
HM53-507R0_LF V or H	10.0	7.0	20.9	5.6	34.0 / 21.4 / 34.0	34.0 / 34.0 / 21.4	90	75
HM53-50150_LF V or H	21.2	14.8	16.0	8.2	40.5 / 18.0 / 40.5	40.5 / 40.5 / 18.0	45	75
HM53-50370_LF V or H	52.4	36.7	12.7	15.2	47.5 / 21.3 / 47.5	47.5 / 47.5 / 21.3	45	45
HM53-50550_LF V or H	77.6	54.2	10.5	21.1	47.5 / 21.3 / 47.5	47.5 / 47.5 / 21.3	45	45
HM53-50700_LF V or H	99.4	69.5	13.0	13.6	57.0 / 27.5 / 57.0	57.0 / 57.0 / 27.5	45	45
HM53-607R0_LF V or H	9.9	6.9	29.3	4.3	50.3 / 24.0 / 50.3	50.3 / 50.3 / 24.0	45	45
HM53-60130_LF V or H	19.2	13.5	29.5	4.8	59.0 / 28.0 / 59.0	59.0 / 59.0 / 28.0	45	45
HM53-60350_LF V or H	50.2	35.1	21.0	9.2	63.0 / 36.0 / 63.0	63.0 / 63.0 / 36.0	20	20

Notes: (1) Inductance is measured at 100kHz, 0.1V without DC current.
 (2) Value with rated DC current and the operating ETop across the inductor.

Outline Dimensions (mm)

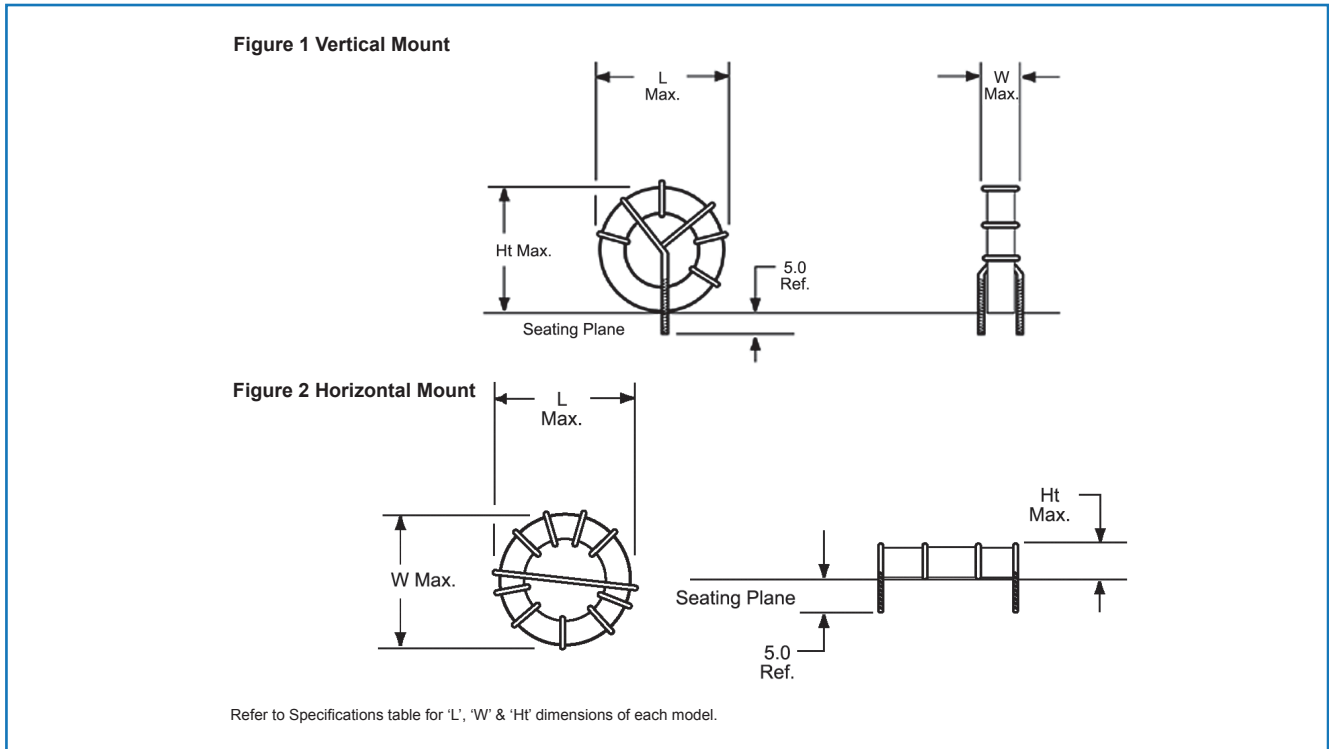

Ordering Information

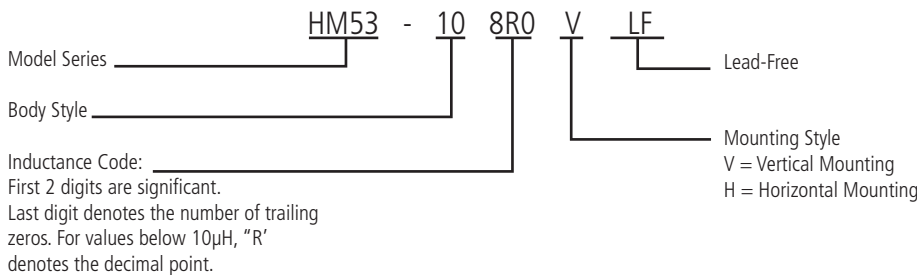

General Note

TT Electronics reserves the right to make changes in product specification without notice or liability.
 All information is subject to TT Electronics' own data and is considered accurate at time of going to print.

Model HM53

Electrical Characteristics @ 25°C

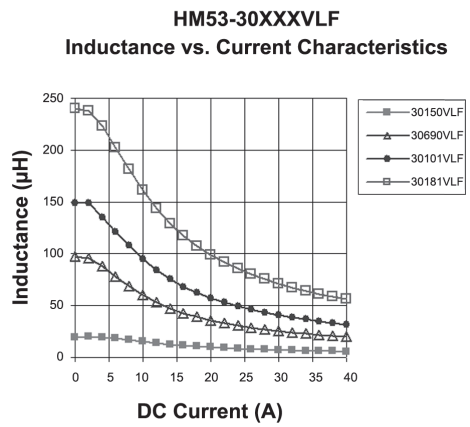
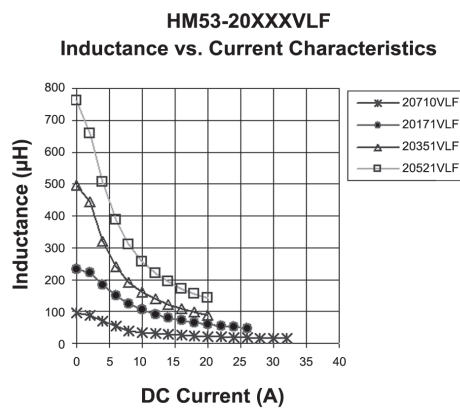
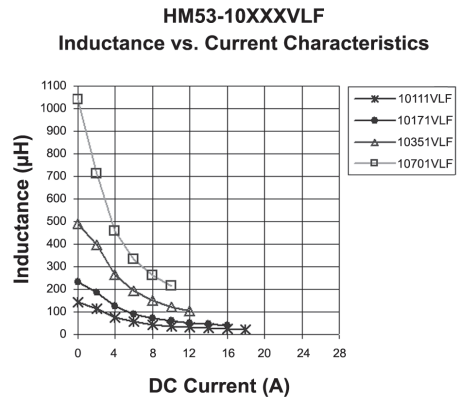
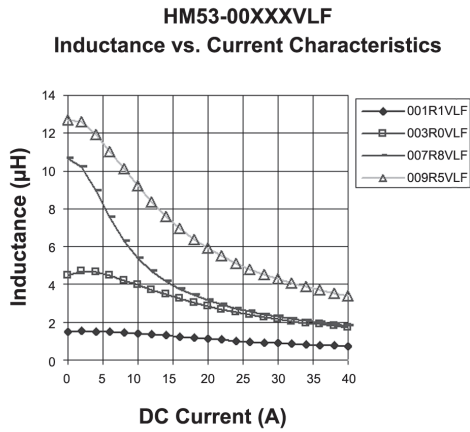

General Note

TT Electronics reserves the right to make changes in product specification without notice or liability. All information is subject to TT Electronics' own data and is considered accurate at time of going to print.

Model HM53

Electrical Characteristics @ 25°C (Cont'd)

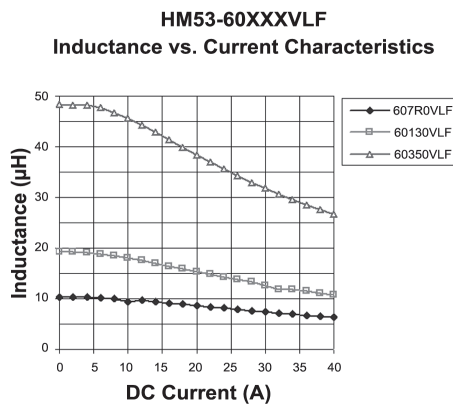
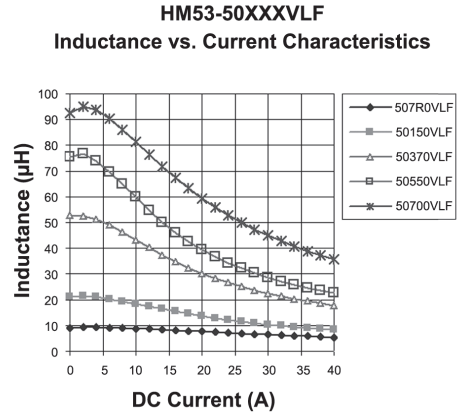
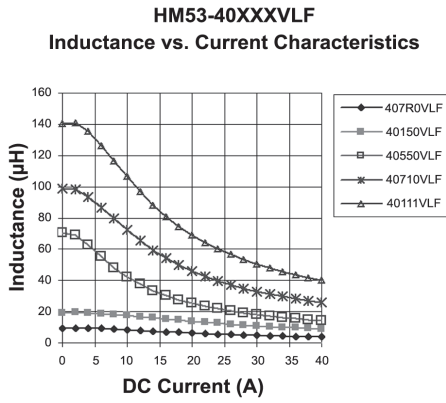

General Note

TT Electronics reserves the right to make changes in product specification without notice or liability. All information is subject to TT Electronics' own data and is considered accurate at time of going to print.