

Advance Information

Remote Control Encoder/Decoder
LSI CMOS

The MC145030 encodes and decodes nine bits of information, which allows 512 different codes.

The encoder section samples the 9-bit parallel address input, encodes the bits into Manchester Code, and sends the serial information via the Encoder Out pin. The address is issued twice per encoding sequence; initialization occurs with a rising edge on Encode Enable.

The decoder accepts serial information at the Decoder In pin, and decodes the Manchester information. The decoded address is compared with the local address. If a match occurs, Decoder Out toggles once per sequence. The active-high Decoder Reset input is used to clear Decoder Out.

The Status pin, when high, indicates the device is encoding. During decoding or standby, Status is low.

- Applications: Cordless Phones and Half-Duplex Remote Control
- Interfaces with RF, Ultrasonic, or Infrared Modulators and Demodulators
- Operating Temperature Range: - 40 to 85°C
- Operating Voltage Range: 2 to 6 V
- Standby Supply Current: 20 μ A Maximum @ 2.0 V
- Operating Supply Current: 700 μ A Maximum @ 2.5 V
- Address Inputs Have On-Chip Pull-Up Devices
- RC Oscillator, No Crystal Required
- On-Chip Amplifier in Decode Section
- Power-On Reset Forces Decoder Out Low and Initializes the Decoder and Encoder Sections
- See Application Note AN1016 and Article Reprint AR255

BLOCK DIAGRAM

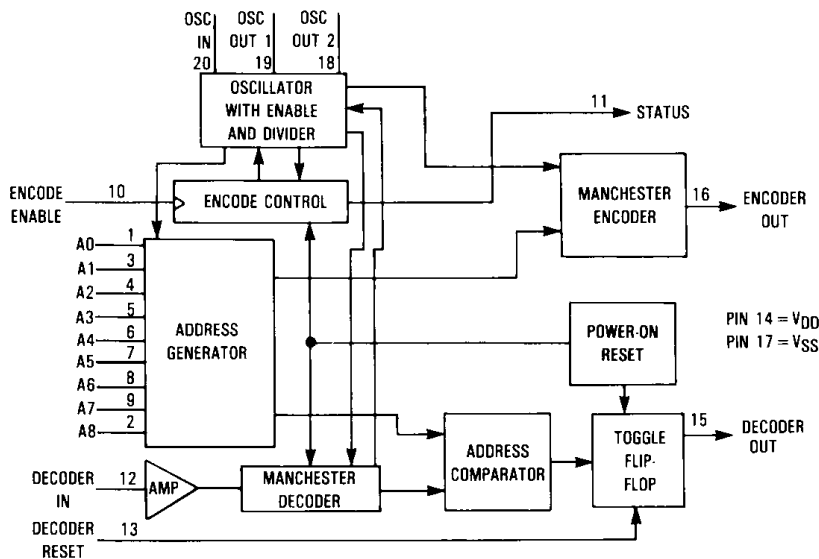

This document contains information on a new product. Specifications and information herein are subject to change without notice.

MC145030

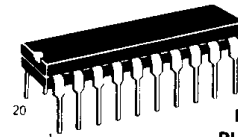

P SUFFIX
PLASTIC DIP
CASE 738

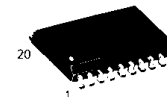

DW SUFFIX
SOG
CASE 751D

ORDERING INFORMATION

MC145030P Plastic DIP
 MC145030DW SOG Package

PIN ASSIGNMENT

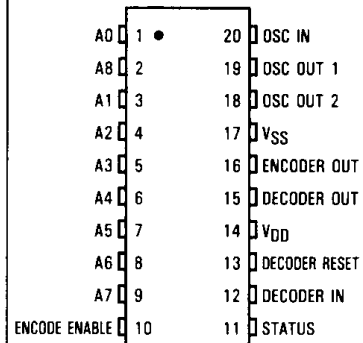

MAXIMUM RATINGS* (Voltage Referenced to V_{SS})

Symbol	Parameter	Value	Unit
V _{DD}	DC Supply Voltage	- 0.5 to + 7.0	V
V _{in}	DC Input Voltage	- 0.5 to V _{DD} + 0.5	V
V _{out}	DC Output Voltage	- 0.5 to V _{DD} + 0.5	V
I _{in}	DC Input Current, per Pin	± 10	mA
I _{out}	DC Output Current, per Pin	± 10	mA
I _{DD}	DC Supply Current, V _{DD} and V _{SS} Pins	± 30	mA
P _D	Power Dissipation, per Package†	500	mW
T _{stg}	Storage Temperature	- 65 to + 150	°C
T _L	Lead Temperature (10-Second Soldering)	260	°C

*Maximum Ratings are those values beyond which damage to the device may occur.
 †Power Dissipation Temperature Derating: - 12 mW/°C from 65°C to 85°C.

This device contains protection circuitry to guard against damage due to high static voltages or electric fields. However, precautions must be taken to avoid applications of any voltage higher than maximum rated voltages to this high-impedance circuit. For proper operation, V_{in} and V_{out} should be constrained to the range V_{SS} ≤ (V_{in} or V_{out}) ≤ V_{DD}.
 Except for the Address inputs, unused inputs must always be tied to an appropriate logic voltage level (e.g., either V_{SS} or V_{DD}). The Address inputs may be left open; see Pin Descriptions. Unused outputs must be left open.

6

ELECTRICAL CHARACTERISTICS (T_A = 25°C, Voltages Referenced to V_{SS})

Symbol	Parameter	Test Condition	V _{DD} V	Guaranteed Limit	Unit
V _{DD}	Power Supply Voltage Range		-	2.0 to 6.0	V
V _{IL}	Maximum Low-Level Input Voltage	Except Decoder In	2.5 6.0	0.3 1.2	V
V _{IH}	Minimum High-Level input Voltage	Except Decoder In	2.5 6.0	1.9 4.5	V
V _{sig}	Minimum Output Voltage of Signal Source Driving Decoder In	Square-Wave Source See Figure 1	2.5 6.0	200 200	mVp-p
V _{OL}	Maximum Low-Level Output Voltage	I _{out} = 0 μA I _{out} = 0.4 mA	2.5	0.15 0.4	V
		I _{out} = 0 μA I _{out} = 1.0 mA	6.0	0.15 0.4	
V _{OH}	Minimum High-Level Output Voltage	I _{out} = 0 μA I _{out} = - 0.4 mA	2.5	2.35 2.0	V
		I _{out} = 0 μA I _{out} = - 1.0 mA	6.0	5.85 5.5	
I _{in}	Maximum Input Current	Decoder In Encode Enable, Decoder Reset, Osc In V _{in} = V _{DD} or V _{SS}	6.0	± 60 ± 0.3	μA
I _{IH}	Maximum High-Level Input Leakage Current	A0-A8 V _{in} = V _{DD}	6.0	0.3	μA
I _{IL}	Maximum Low-Level Pull-Up Current	A0-A8 V _{in} = V _{SS}	6.0	- 100	μA
I _{OZ}	Maximum 3-State Leakage Current	Encoder Out V _{out} = V _{DD} or V _{SS}	6.0	± 500	nA
I _{DD}	Maximum Quiescent Supply Current (per Package)	Device in Standby Mode V _{in} = V _{SS} or V _{DD} for Encode Enable, Decoder In, Decoder Reset, Osc In V _{in} = V _{SS} , V _{DD} , or Open for A0-A8 I _{out} = 0 μA	2.0 6.0	20 100	μA
		Oscillator Frequency = 500 kHz V _{in} = V _{SS} or V _{DD} for Encode Enable, Decoder In, Decoder Reset, Osc In V _{in} = V _{SS} , V _{DD} , or Open for A0-A8 I _{out} = 0 μA	2.5 6.0	700 2500	

AC ELECTRICAL CHARACTERISTICS (T_A = 25°C, C_L = 50 pF, V_{DD} = 2.5 to 6 V unless otherwise stated)

Symbol	Parameter	V _{DD} V	Guaranteed Limit	Unit
f _{osc}	Maximum Oscillator Frequency (~50% Duty Cycle) (Figure 2)*	—	500	kHz
t _{PLH} , t _{PHL}	System Propagation Delay, Encode Enable (of an encoding device) to Decoder Out (of a decoding device) Figures 3 and 5	—	384 to 608	Osc Cycles
t _d	Debounce Time, Encode Enable (guarantees 1 encoding sequence)	—	608	Osc Cycles
t _w	Minimum Input Pulse Width, Encode Enable or Decoder Reset (Figure 4)	2.5 6.0	200 80	ns
C _{in}	Maximum Input Capacitance	—	10	pF

*See Pin Descriptions and Application Example for component tolerances.

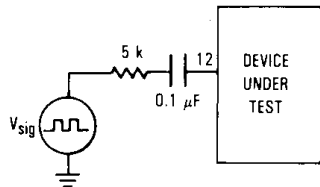

Figure 1. Decoder In Sensitivity Test

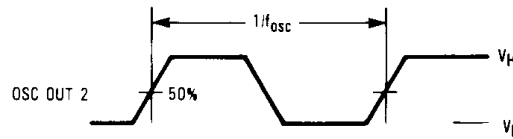

Figure 2. Switching Waveform

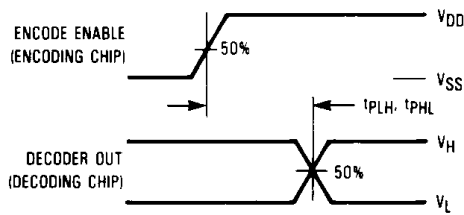

Figure 3. Switching Waveforms

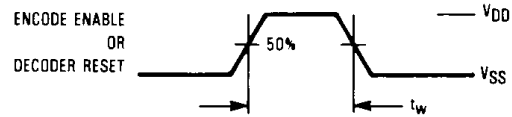
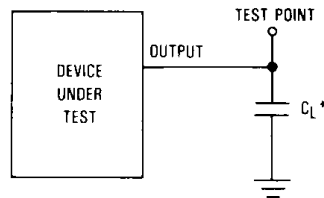

Figure 4. Switching Waveform



*Includes all probe and jig capacitance.

Figure 5. Test Circuit

PIN DESCRIPTIONS

INPUTS

A0 through A8 (Pins 1, 3-9, 2)

Local Address Inputs. These binary inputs provide the address for both the encoder and decoder; 512 addresses are possible. The local address is sent serially from Encoder Out with 2 sync bits appearing first, followed by A0. The decoder compares the local address with the received address stream.

On-chip pullup devices are provided on the address inputs to facilitate interface to SPST switches or jumpers to V_{SS}. During standby, A0 through A8 are in the high-impedance state. That is, the pullup devices are inactive to minimize standby power consumption.

The inputs are left open (or tied to V_{DD}) for a high level and tied to V_{SS} for a low level.

Encode Enable (Pin 10)

Edge-Sensitive Encode Enable. A low-to-high transition on this pin aborts any decoding sequence in progress and initiates an encoding sequence. This input is debounced 608 oscillator cycles. See Figures 8 and 9.

Decoder In (Pin 12)

Decoder In is the input to the on-chip amplifier. The incoming signal is usually capacitively-coupled to this pin. Direct coupling may be used if the signal level is rail-to-rail (V_{SS} to V_{DD}).

Decoder Reset (Pin 13)

Level-Sensitive Decoder Reset. When this input is taken high, Decoder Out is cleared to a low level. This pin may be used to override a response from a Decoder In data stream.

OUTPUTS

Status (Pin 11)

Encode/Decode Status. This pin is high during the encoding sequence and low during decoding or idle.

When Status is low, the Encoder Out pin is in the high-impedance state.

Decoder Out (Pin 15)

Toggle Flip-Flop Decoder Output. The encoder sends the same address twice to complete a sequence. If one or both of the decoded addresses matches the local address, Decoder Out toggles once per sequence (unless overridden by Decoder Reset). See Figures 6 and 7.

Encoder Out (Pin 16)

Three-State Encoder Output. This is the serial output of the Manchester-encoded local address. A0 appears before A8 in the bit stream. The local address is sent twice to complete a sequence which is initialized by Encode Enable. When a sequence is complete, Encoder Out returns to the high-impedance state. See Figures 8 and 9.

OSCILLATOR

Osc In, Osc Out 1, Osc Out 2 (Pins 20, 19, 18)

As shown in Figure 10, these pins are used in conjunction with external resistors and a capacitor to form an oscillator. Polystyrene or mylar capacitors are recommended. Susceptibility to externally induced noise signals may occur if resistors utilized are greater than 1 megohm. See Figure 10 for component tolerances.

When the on-chip oscillator is used, the frequency may be up to 500 kHz. The oscillator is active only during encoding or decoding.

When an external frequency source is used to drive Osc In, Osc Out 1, and Osc Out 2 may be left floating. The signal applied to Osc In should swing rail-to-rail and may be dc to 500 kHz.

POWER

V_{SS} (Pin 17)

This pin is the negative supply potential and is usually ground.

V_{DD} (Pin 14)

This pin is the positive supply potential and may range from +2 to +6 volts with respect to V_{SS}.

6

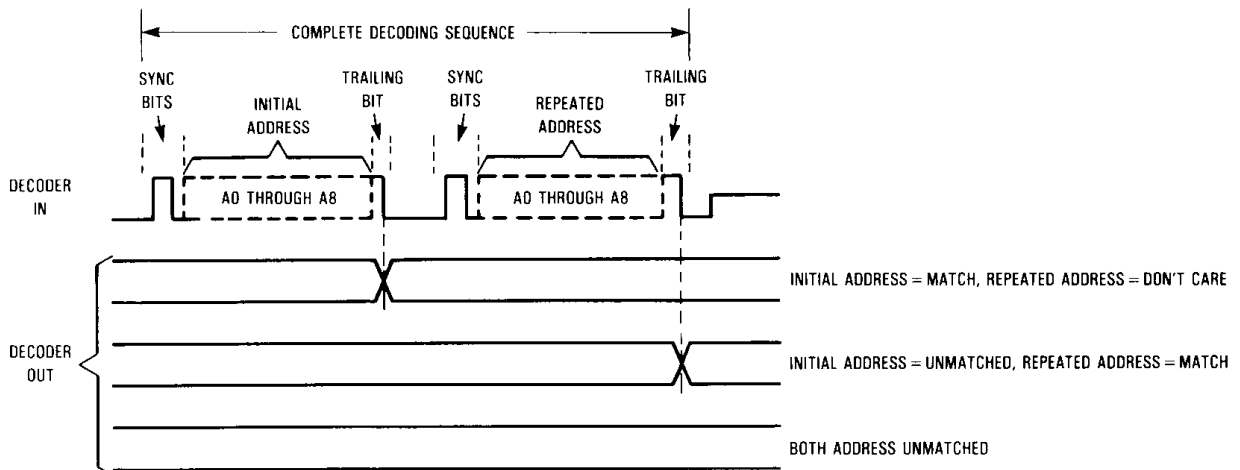
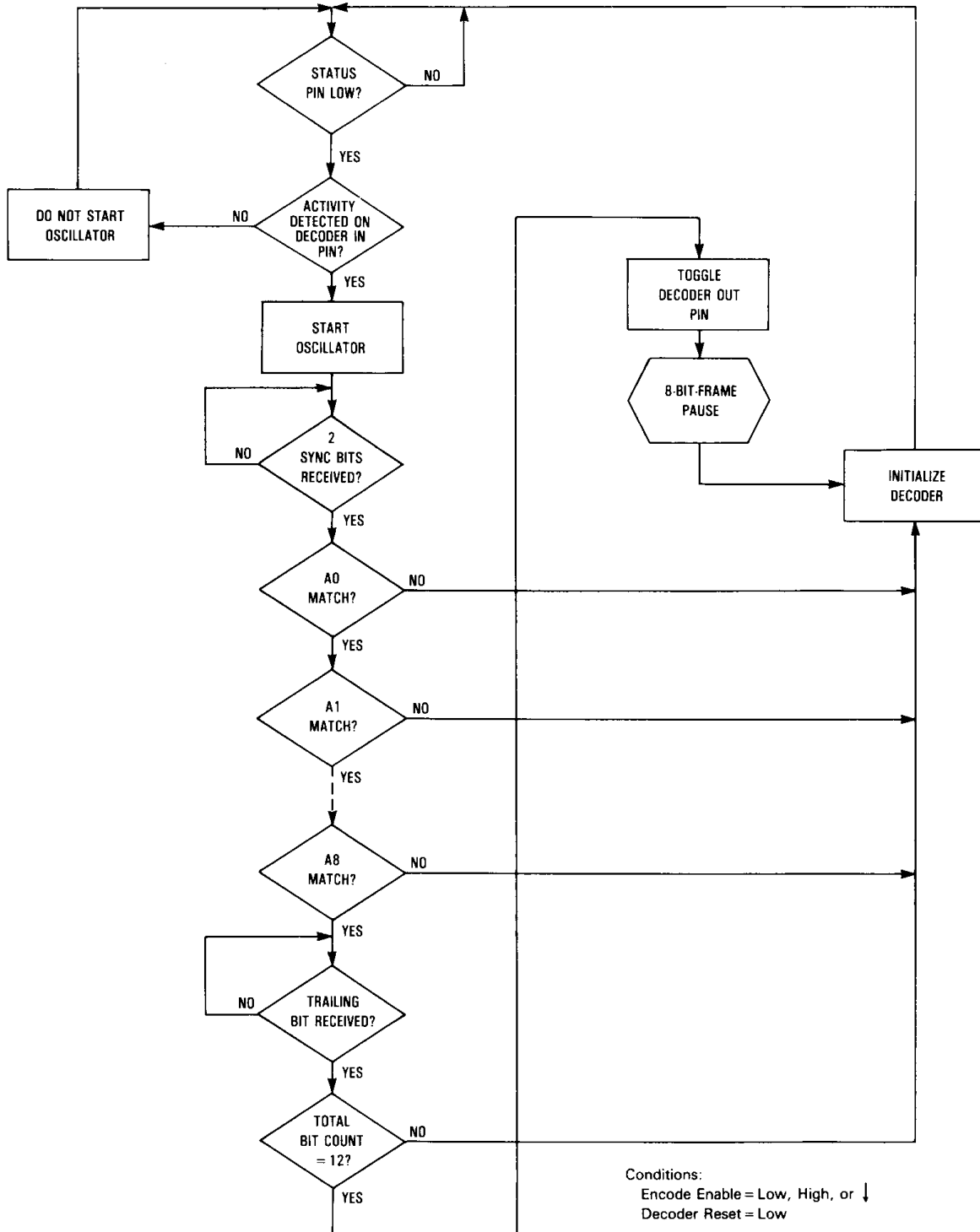

Figure 6. Decoder Timing Diagram



6

Figure 7. Decoder Flowchart

6

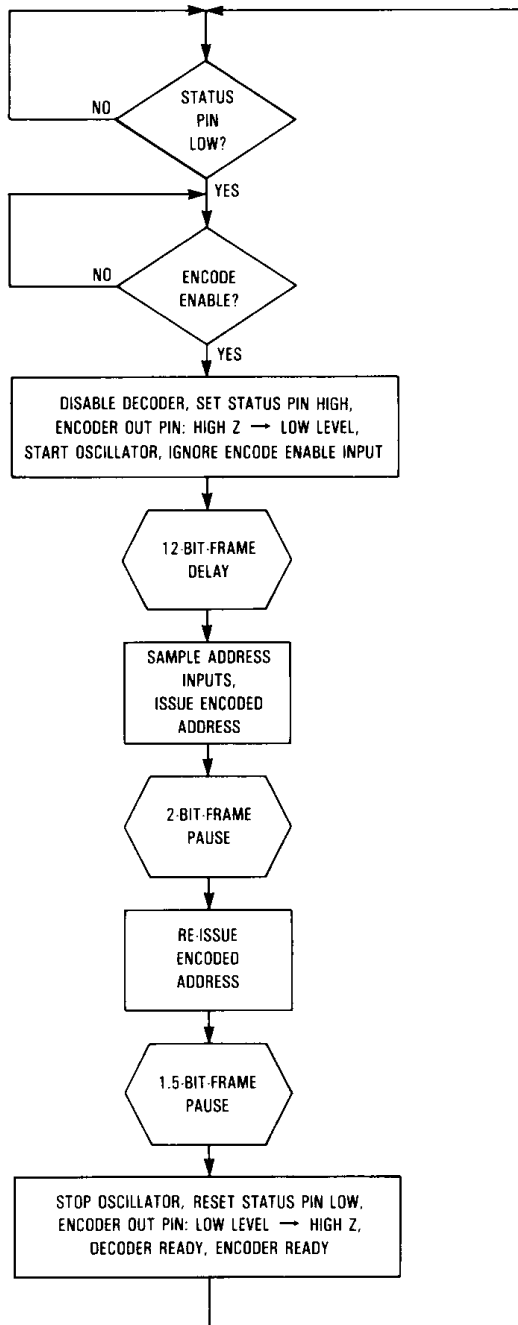

Figure 8. Encoder Flowchart

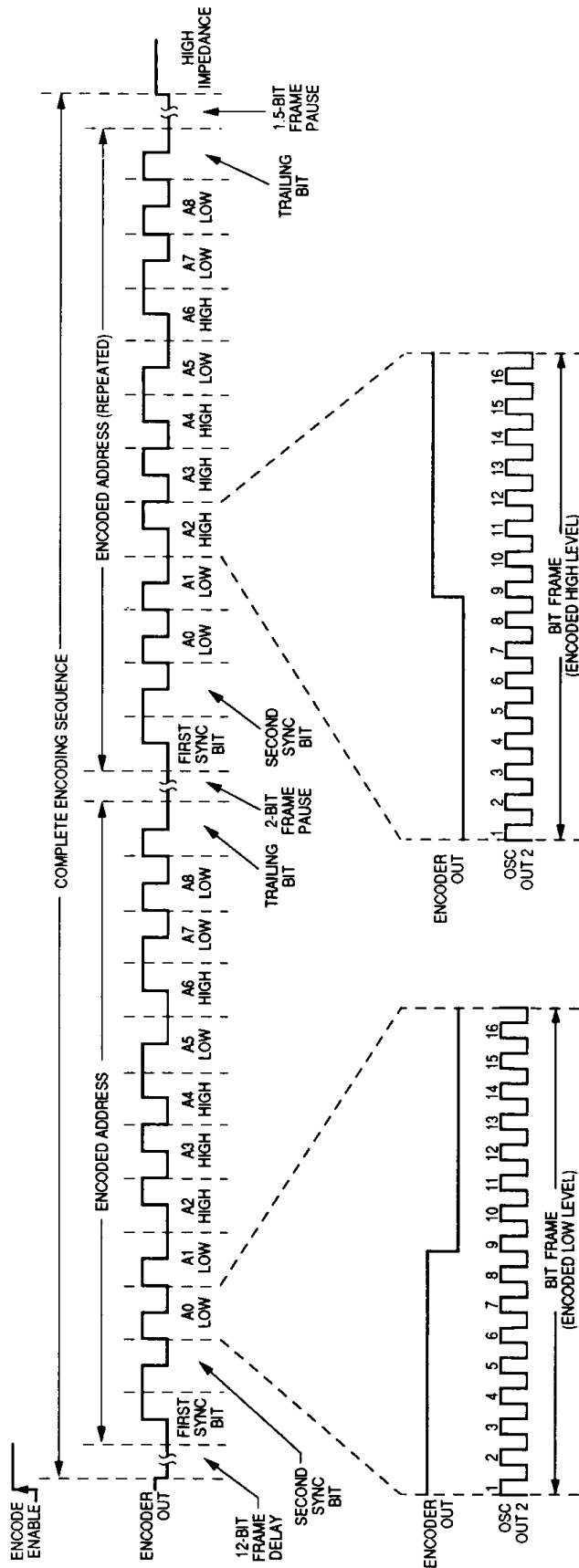

Figure 9. Encoder Timing Diagram

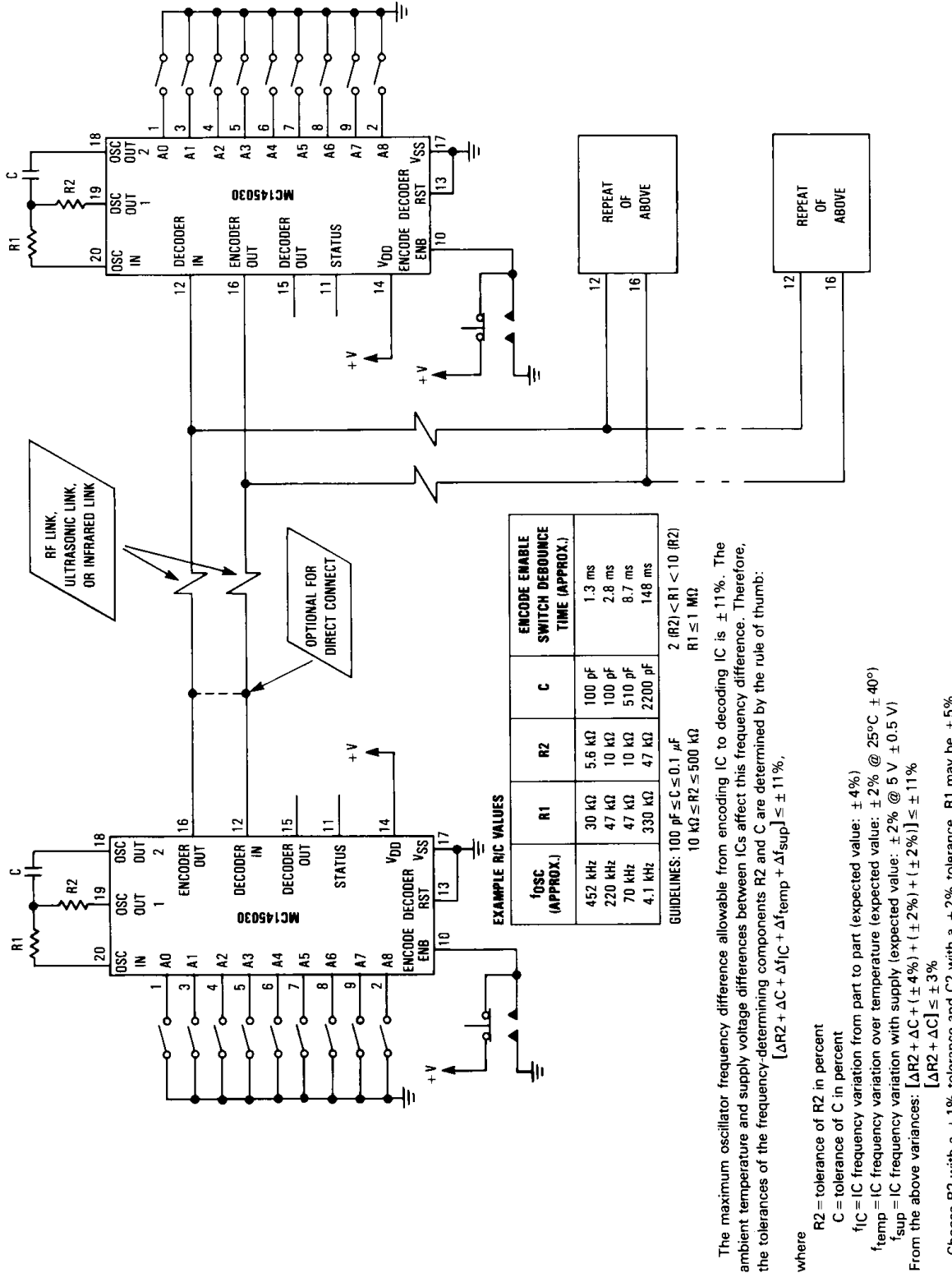

Figure 10. Application Example