

Thermal Overload Relay J7TKN

Thermal Overload Relay

- Direct and separate mounting
- Single phasing sensivity according to IEC 947-4-1
- Finger proof (VBG 4)

Accessoires

- Busbar sets
- Set for single mounting



Approved Standards

Standard	Guide No (US,C)
UL	NKCR, NKCR7
ICE 947-4-1	
VDE 0660	
EN 60947-4-1	

Ordering Information

■ Model Number Legend

1. Thermal Overload Relay

J7TKN-□-□□□
1 2 3

- 1) Thermal Overload Relay
- 2) A: for mini motor contactor and motor contactor (4-11 kW)
B: for motor contactor (4-15 kW)
C: for motor contactor (18.5 kW)
D: for motor contactor (22-37 kW)
E: for motor contactor (45-55 kW)
F: for motor contactor (75-110 kW)
- 3) Setting range (examples)
E16: 0.12-0.16 A
E27: 0.18-0.27 A
...
2E7: 1.8-2.7 A
...
11: 8-11 A





2. Accessories for Thermal Overload Relay

J74TK-□-□□□
1 2 3

- 1) Accessories for Thermal Overload Relay
- 2) SM: Single mounting for J7TKN-B Types (4-32 kW)
SU: Busbar sets
- 3) 175: for J7TKN-F Types (75-90 kW)
200: for J7TKN-F Types (110 kW)

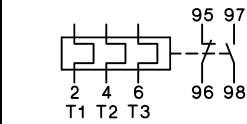

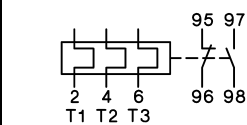
■ System overview

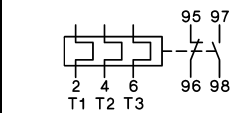
Thermal Overload Relays for plug-in mounting

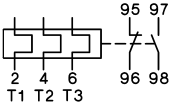
	Setting Range		Star Delta (A)	Type	Pack pcs.	Weight kg/pc.	
	D.O.L. (A)						
For contactors J7KNA-09..., J7KNA-12..., J7KN-10... to J7KN-22...							
	0.12 - 0.18	-	-	 hand reset	J7TKN-A-E18	1	0.10
	0.18 - 0.27	-	-		J7TKN-A-E27	1	0.10
	0.27 - 0.4	-	-		J7TKN-A-E4	1	0.10
	0.4 - 0.6	-	-		J7TKN-A-E6	1	0.10
	0.6 - 0.9	-	-		J7TKN-A-E9	1	0.10
	0.8 - 1.2	-	-		J7TKN-A-1E2	1	0.10
	1.2 - 1.8	-	-		J7TKN-A-1E8	1	0.10
	1.8 - 2.7	-	-		J7TKN-A-2E7	1	0.10
	2.7 - 4	-	-		J7TKN-A-4	1	0.10
	4 - 6	7 - 10.5	-		J7TKN-A-6	1	0.10
	6 - 9	10.5 - 15.5	-		J7TKN-A-9	1	0.10
	8 - 11	14 - 19	-		J7TKN-A-11	1	0.10
	10 - 14	18 - 24	-		J7TKN-A-14	1	0.10
	13 - 18	23 - 31	-		J7TKN-A-18	1	0.10
17 - 23	30 - 40	-	J7TKN-A-23	1	0.10		
22 - 30	38 - 52	-	J7TKN-A-30	1	0.10		
For contactors J7KN-10... to J7KN-40...							
	0.12 - 0.18	-	-	 hand- and auto reset	J7TKN-B-E18	1	0.14
	0.18 - 0.27	-	-		J7TKN-B-E27	1	0.14
	0.27 - 0.4	-	-		J7TKN-B-E4	1	0.14
	0.4 - 0.6	-	-		J7TKN-B-E6	1	0.14
	0.6 - 0.9	-	-		J7TKN-B-E9	1	0.14
	0.8 - 1.2	-	-		J7TKN-B-1E2	1	0.14
	1.2 - 1.8	-	-		J7TKN-B-1E8	1	0.14
	1.8 - 2.7	-	-		J7TKN-B-2E7	1	0.14
	2.7 - 4	-	-		J7TKN-B-4	1	0.14
	4 - 6	7 - 10.5	-		J7TKN-B-6	1	0.14
	6 - 9	10.5 - 15.5	-		J7TKN-B-9	1	0.14
	8 - 11	14 - 19	-		J7TKN-B-11	1	0.14
	10 - 14	18 - 24	-		J7TKN-B-14	1	0.14
	13 - 18	23 - 31	-		J7TKN-B-18	1	0.14
17 - 24	30 - 41	-	J7TKN-B-24	1	0.14		
23 - 32	40 - 55	-	J7TKN-B-32	1	0.14		
For contactors J7KN-24... to J7KN-40...							
	28 - 42	48 - 73	-		J7TKN-C-42	1	0.30

	Setting Range			Type	Pack pcs.	Weight kg/pc.
	D.O.L. (A)	Star Delta (A)				
For contactors J7KN-50...-J7KN-74...						
	40 - 52	70 - 90		J7TKN-D-52	1	0.40
	52 - 65	90 - 112		J7TKN-D-65	1	0.40
	60 - 74	104 - 128		J7TKN-D-74	1	0.40

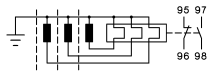
Thermal Overload relays for separate mounting

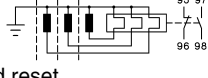
	Setting Range			Type	Pack pcs.	Weight kg/pc.
	D.O.L. (A)	Star Delta (A)				
For contactors J7KN-85... to J7KN-150...						
	60 - 90	104 - 156		J7TKN-E-90	1	0.90
	80 - 120	140 - 207		J7TKN-E-120	1	0.90
For contactors J7KN-175... to J7KN-200...						
	100 - 150	175 - 260		J7TKN-F-150	1	1.5
	140 - 220	240 - 380 busbar sets see accessories		J7TKN-F-210	1	1.5

Accessories

	for overload relays	for contactors	Type	Pack pcs.	Weight kg/pc.
Busbar Sets					
	J7TKN-F-175	J7KN-150, J7KN-175	J73TK-SU-175	1	0.6
	J7TKN-F-210	J7KN-200	J73TK-SU-200	1	0.7
	busbars must be installed by users				

	for overload relay	Cable Cross-section to clamp (mm ²)			Type	Pack pcs.	Weight kg/pc.
		solid or stranded	flexible	flex. with multicore cable end			
Sets for single mounting							
	U3/32	0.75 - 6	0.75 - 4	0.5 - 4	J73TK-SM	1	0.035

Specifications

Engineering data and Characteristics

Thermal Overload Relays, tripping times for selection to motors of protection degree EEx e Relays With Standard Tripping Characteristic

Setting Range		Tripping time depending on the multiple of the current setting from cold condition (tolerance ±20% of the tripping time)					
A	A	I_A/I_N	I_A/I_N	I_A/I_N	I_A/I_N	I_A/I_N	I_A/I_N
J7TKN-A-...		s	s	s	s	s	s
0,12	- 0,18	18,5	10,4	7,2	5,5	4,3	3,6
0,18	- 0,27	16,7	9,8	6,5	5	4,1	3,5
0,27	- 0,4	19,4	12,1	8,2	5,9	4,9	4,2
0,4	- 0,6	18,7	11,2	8	6	4,9	4,1
0,6	- 0,9	19,7	11,6	8,1	6,1	4,9	4,2
0,8	- 1,2	22,9	13,6	10	7,3	6	5,2
1,2	- 1,8	22,2	13,2	9,2	7,6	5,8	5,3
1,8	- 2,7	23	13,7	9,3	7,6	5,7	5,1
2,7	- 4	24	14,4	9,9	7,8	5,9	5,1
4	- 6	24,7	13,8	9,9	7,3	5,6	4,8
6	- 9	22	13,4	8	5,7	4,1	3,5
8	- 11	17,4	9,2	5,9	4,1	2,9	2,3
10	- 14	26,4	12,9	7,6	5,2	3,5	2,8
13	- 18	14,7	7,7	4,8	3,2	2,3	1,7
17	- 23	16,2	8,4	5	3,6	2,4	1,8
22	- 30	16,8	8,5	5	3,6	2,3	1,9
J7TKN-C-42		s	s	s	s	s	s
28	- 42	25,2	13,3	8	5,5	4	3,1
J7TKN-D-...		s	s	s	s	s	s
40	- 52	18,3	9,2	5,6	3,9	2,8	2,2
52	- 65	17,8	8,7	5,2	3,4	2,5	1,9
60	- 74	19,5	13,5	11	10	9,5	8,5
J7TKN-E-...		s	s	s	s	s	s
60	- 90	19,5	13,5	11	10	9,5	8,5
80	- 120	18	11	10	9	8,5	8
J7TKN-F-...		s	s	s	s	s	s
100	- 150	34	26	24	20,5	19	18
140	- 210	30	24	21	18,5	17	16

All tripping times of overload relays J7TKN-A are shorter than the minimum values of the t_E time for motors of protection degree EEx e acc. to EN 50019 and therefore are suitable for all motors of protection degree EEx e. For these overload relays the selection on basis of tripping curves is thereby not necessary.

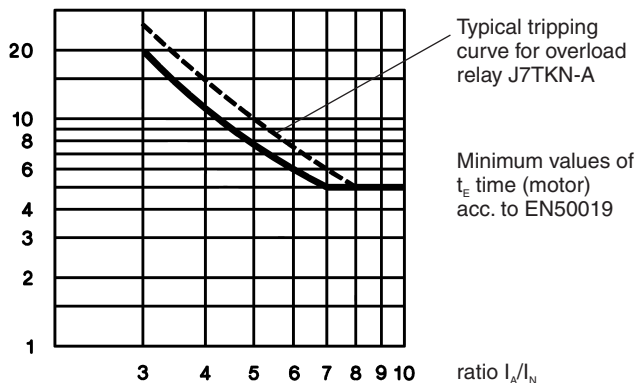

Labels of tripping curves for each setting range, sized 148x105mm (self-adhesive) are available on request.

Specify type and setting range.

When selecting a standard overload, refer to the tripping curve. Determine the values of the starting current ratio I_A/I_N and the time t_E which is marked on the label of the motor. The overload must trip within the t_E time, which means that the tripping curve from cold condition must be (20% due to tolerance) below the coordination point I_A/I_N and the time t_E .

I_A = Starting current of motor

I_N = Rated current of motor

t_E = t_E -time of motor

Fuses for J7TKN-A; J7TKN-B; J7TKN-C; J7TKN-D; J7TKN-E; J7TKN-F

Type	Setting Range				Max. Fuse Size According to Coordination-type				Fuse UL		
	DOL		Star Delta		"2" ^{*1} quick	slow, gL(gG)	"1" ^{*1} slow, gL(gG)	aM			
	A		A		A	A	A	A			
J7TKN-A	0.12	-	0.18	-	-	0.5 ^{*2}	0.5 ^{*2}	25	-	15	
J7TKN-B	0.18	-	0.27	-	-	1.0 ^{*2}	1.0 ^{*2}	25	-	15	
	0.27	-	0.4	-	-	2	2	25	-	15	
	0.4	-	0.6	-	-	2	2	25	-	15	
	0.6	-	0.9	-	-	4	4	25	-	15	
	0.8	-	1.2	-	-	4	4	25	2	15	
	1.2	-	1.8	-	-	6	6	25	2	15	
	1.8	-	2.7	-	-	10	10	25	4	15	
	2.7	-	4	-	-	16	10	25	4	15	
	4	-	6	7	-	10.5	20	16	25	6	15
	6	-	9	10.5	-	15.5	35	25	35	10	25
	8	-	11	14	-	19	35	25	35	16	30
	10	-	14	18	-	24	50	35	63	16	40
	13	-	18	23	-	31	50	35	63	20	50
	17	-	(23)24	30	-	(40)41	63	50	63	25	60
	(22)23	-	(30)32	(38)40	-	(52)55	80	63	80	35	70
J7TKN-C	28	-	42	48	-	73	100	80	150	50	110
J7TKN-D	40	-	52	70	-	90	160	100	150	63	200
	52	-	65	90	-	112	160	125	150	80	250
	60	-	74	104	-	128	160	125	150	80	250
J7TKN-E	60	-	90	104	-	156	For short circuit protecting overload relays with current transformer use fuse according to the contactor of the combination.			300	
	80	-	120	140	-	207				-	
J7TKN-F	all ranges									-	

*1) Coordination-type according to IEC 947-4-1:

„2“: Light contact welding accepted. Thermal overload relay must not be damaged.

„1“: Welding of contactor and damage of the thermal overload relay allowed.

*2) Miniature fuse

Tripping Characteristics for J7TKN-A, J7TKN-B, J7TKN-C, J7TKN-D

Detailed tripping times for each range see table page 54

with three-phase load

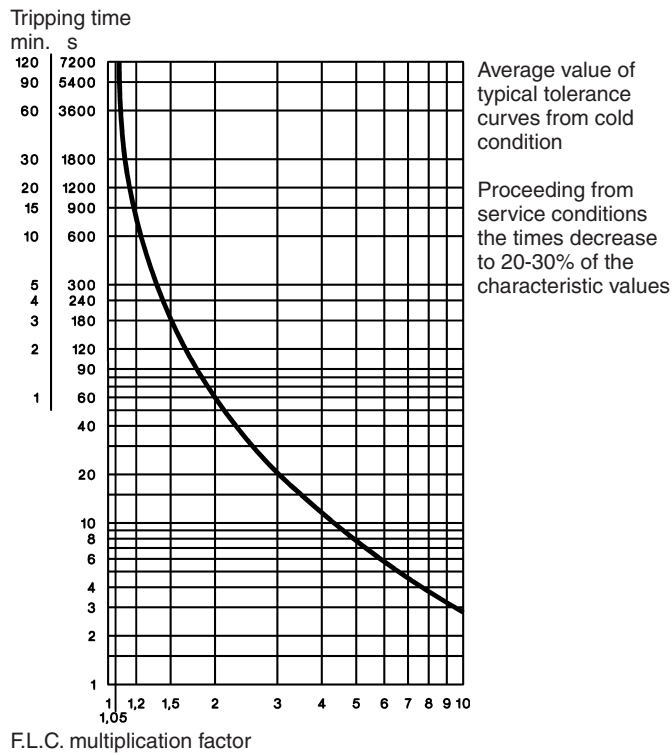

with two-pole load

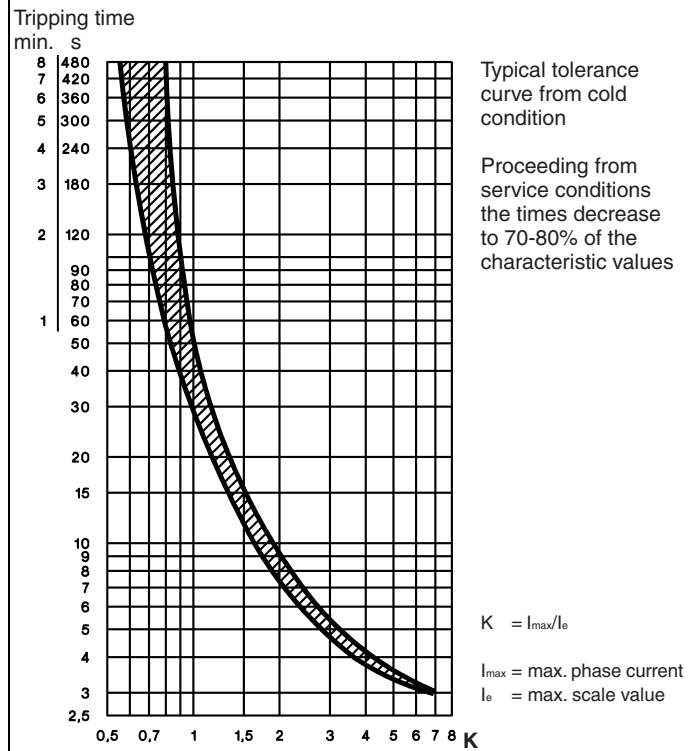

Tripping Characteristics for J7TKN-E

Detailed tripping times for each range see table page 54

with three-phase load

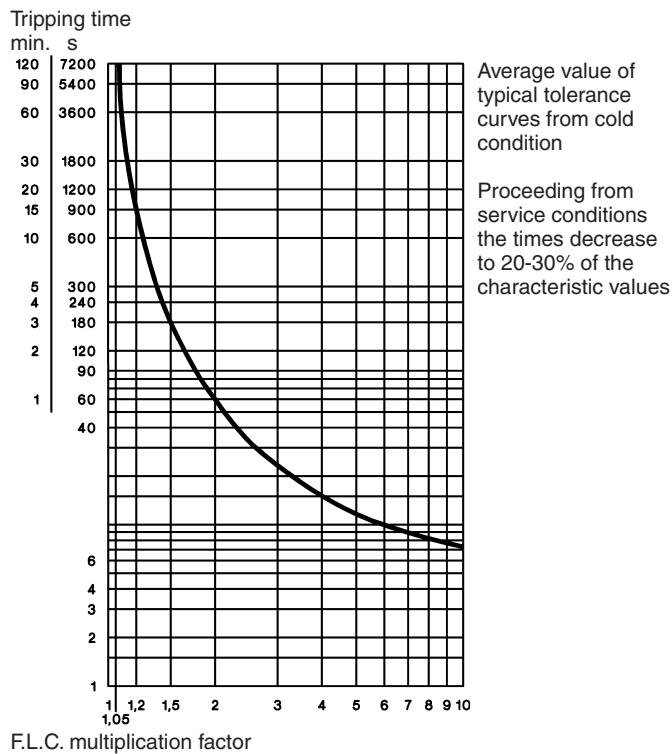

with two-pole load

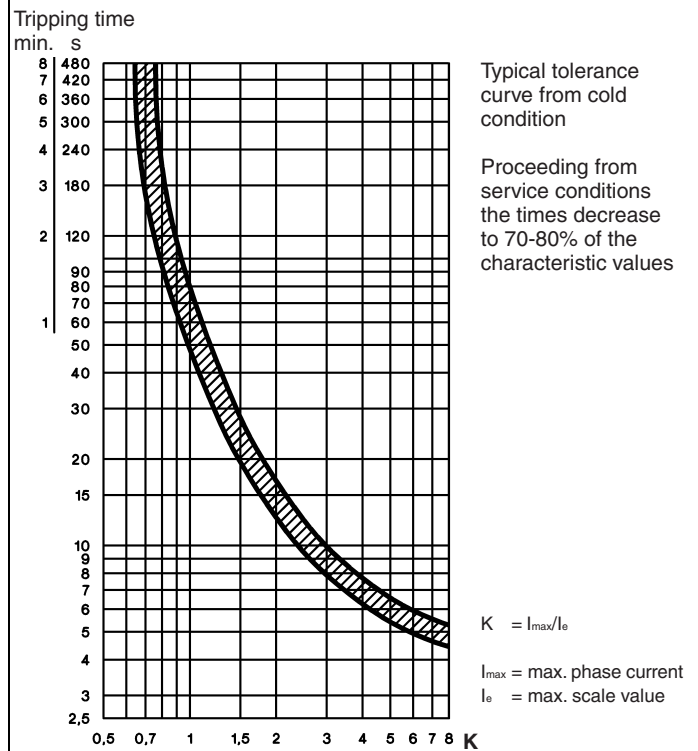

Tripping Characteristics for J7TKN-F

Detailed tripping times for each range see table page 54

with three-phase load

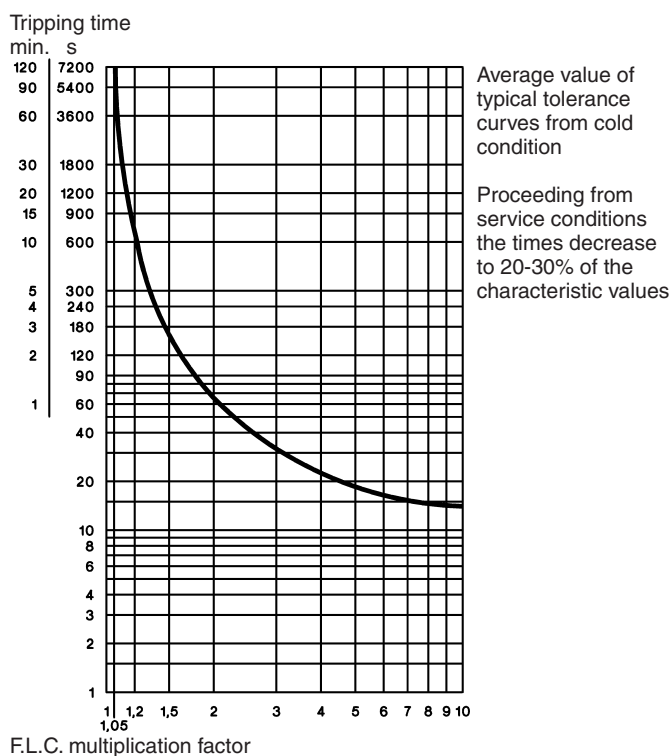

with two-pole load

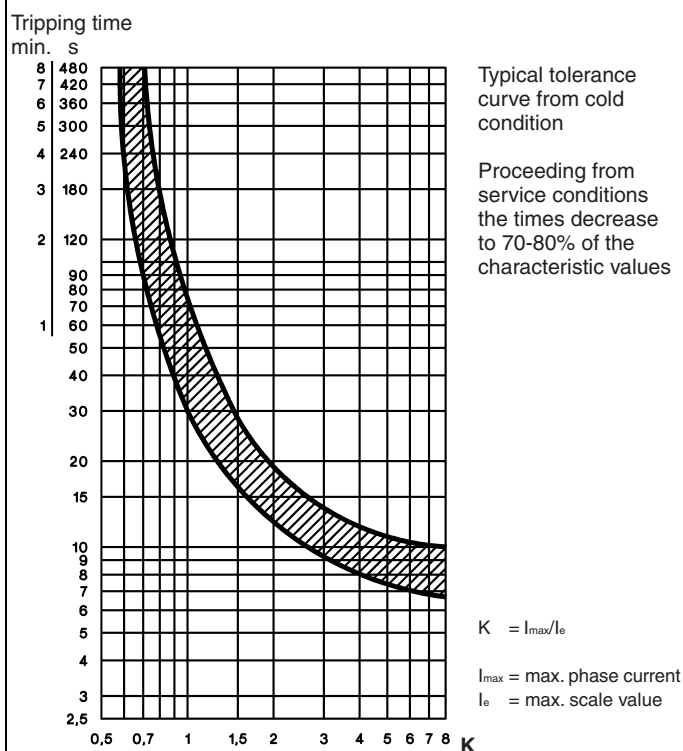

Position of Terminals

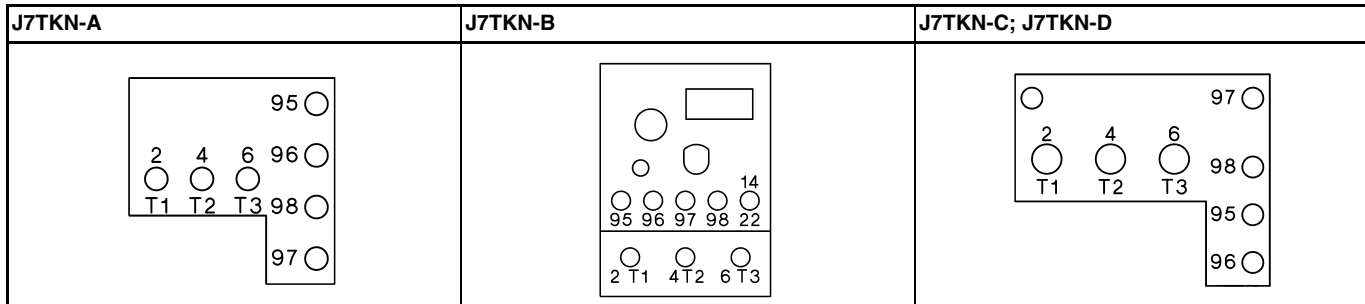

Thermal Overload Relays

Data according to IEC 947-4-1, IEC 947-5-1, VDE 0660, EN 60947-4-1, EN 60947-5-1

Type		J7TKN-A	J7TKN-B	J7TKN-C	J7TKN-D	J7TKN-E	J7TKN-F	
Rated insulation voltage U_i^{*1}	V~	690	690	690	690	750	690	
Permissible ambient temperature								
operation	open °C				-25 to +60			
storage	°C				-50 to +70			
Trip class according to IEC 947-4-1		10A	10A	10A	10A	20	20	
Cable cross-section								
main connector	solid or stranded	mm ²	0.75-6 + 0.75-2.5 ^{*2}	0.75-6	0,75-10	4-35 ^{*2}	^{*3}	^{*4}
		flexible	mm ²	0.75-4 + 0.5-2.5 ^{*2}	1-4	0,75-6	6-25 ^{*2}	
	flexible with multicore cable end	mm ²	0.5-2.5 + 0.5-1.5	0.75-4	0.75-6	4-25		
Cables per clamp	number	1+1	2	2	1			
auxiliary connector	solid	mm ²			0.75-2.5 ^{*2}			
	flexible	mm ²			0.5-2.5 ^{*2}			
	flexible with multicore cable end	mm ²			0.5-1.5			
Cables per clamp	number				2			
Auxiliary contacts								
Rated insulation voltage U_i^{*1}								
same potential	V~	690	690		690		690	
different potential	V~	440	440		250		440	
Utilization category AC15								
Rated operational current I_e	24V	A	5	3		4 ^{*5}	5	
	230V	A	3	2		2.5	3	
	400V	A	2	1		1.5	2	
	690V	A	0.6	0.5		0.6	0.6	
Utilization category DC13								
Rated operational current I_e	24V	A	1.2	1		1.2	1.2	
	110V	A	0.15	0.15		0.15	0.15	
	220V	A	0.1	0.1		0.1	0.1	
Short circuit protection (without welding 1kA)								
highest fuse rating	gL (gG)	A	6	4		6	6	
Setting range	A	to 23	all	28-42	52-65	all	-	
Power loss per current path (max.)								
minimum setting value	W	1.1	1.1	1.3	2.9	1.1	-	
maximum setting value	W	2.3	2.3	3.3	4.5	2.5	-	

*1) Suitable for: earthed-neutral systems, overvoltage category I to III, pollution degree 3 (standard-industry: $U_{imp} = 4kV$ (at 440V), 6kV (at 690V). Data for other conditions on request.

*2) Maximum cable cross-section with prepared conductor

*3) Without terminals, suitable for bushing one connector 70mm² (stranded) per phase

*4) Busbar sets see accessories page 53

*5) Switching capacity of the start contact: AC15 300VA, max. 1.5A, DC13 (max. 220V) 30W, max. 1.5A

Data according to cULus

Type		J7TKN-A	J7TKN-B	J7TKN-C	J7TKN-D	J7TKN-E
Rated insulation voltage	V~	600	600	600	600	600
Rated current	A	23	32	42	74	85
Auxiliary contacts						
Rated voltage						
same potential	V AC	600	600	600	600	600
different potential	V~	150	150	150	150	150
Switching capacity AC						
of aux. contacts	VA	500	500	600	600	600
	A	4	2	4	4	4

Temperature Compensation

In case of higher ambient temperature use the following formula:
 (Ambient temperature - 20) x 0.125 = correction factor in % of the
 full load motor current

Example:

Ambient temperature 70°C, full load motor current 7A

$(70 - 20) \times 0.125 = 6.25\%$

Setting value: $7A + 6,25\% = 7.44A$

■ Dimensions

J7KNA-09 + J7TKN-A
J7KNA-12

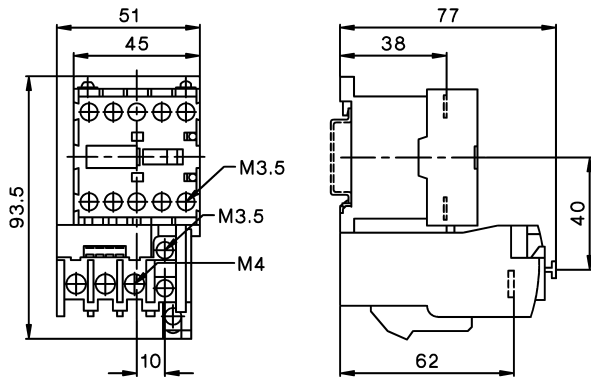

J7KN-10 + J7TKN-B
J7KN-14
J7KN-18
J7KN-22

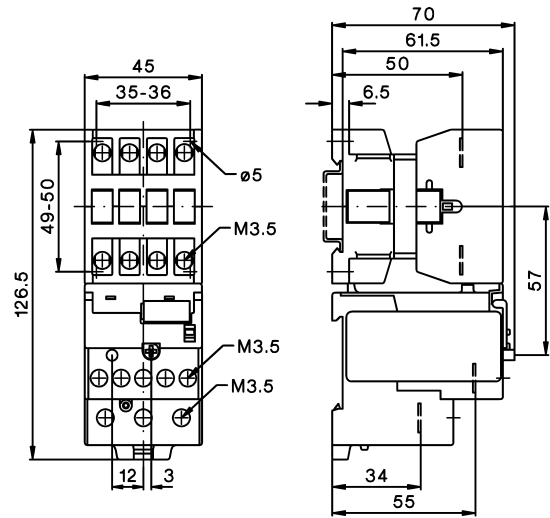

J7KN-10 + J7TKN-A
J7KN-14
J7KN-18
J7KN-22

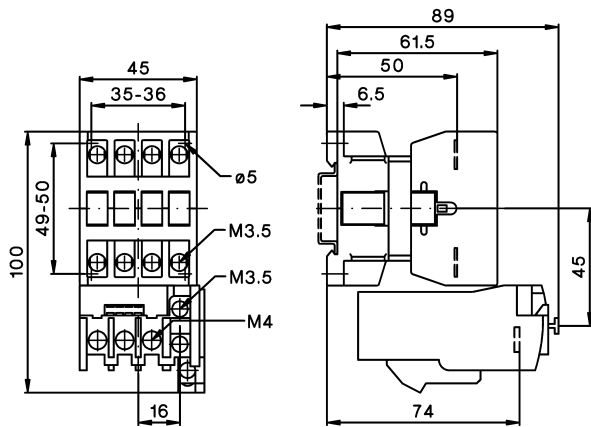

J7KN-24 + J7TKN-B
J7KN-32
J7KN-40

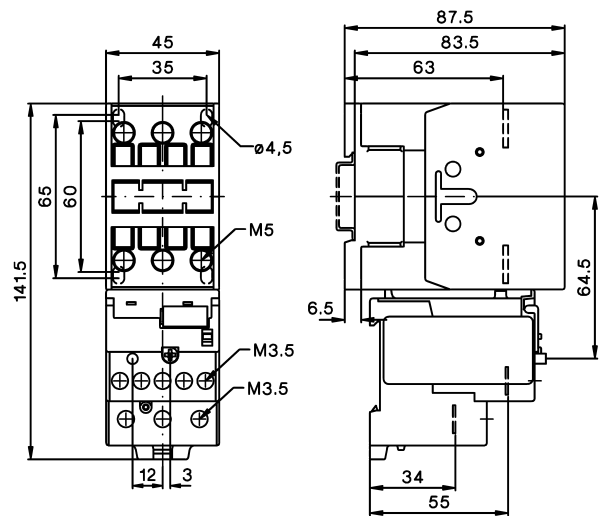

J7KN-24 + J7TKN-C
J7KN-32
J7KN-40

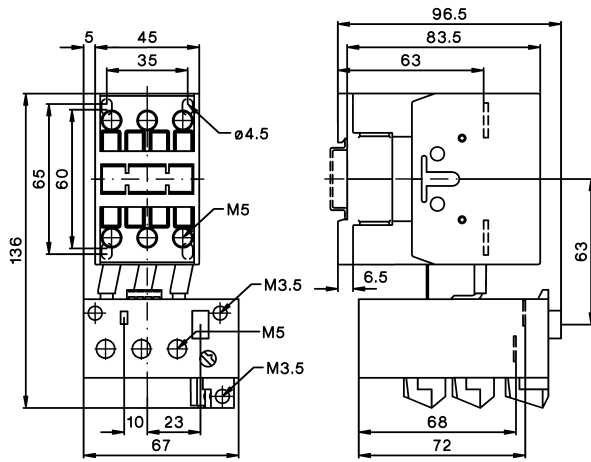

J7KN-50 + J7TKN-D
J7KN-62
J7KN-74

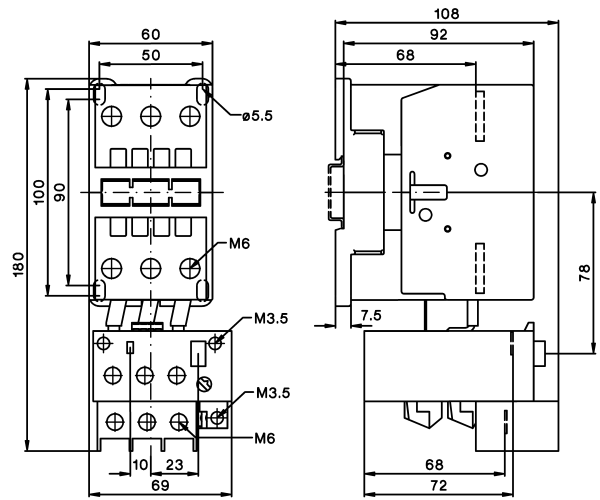

J7KN-85 + J7TKN-E
J7KN-110

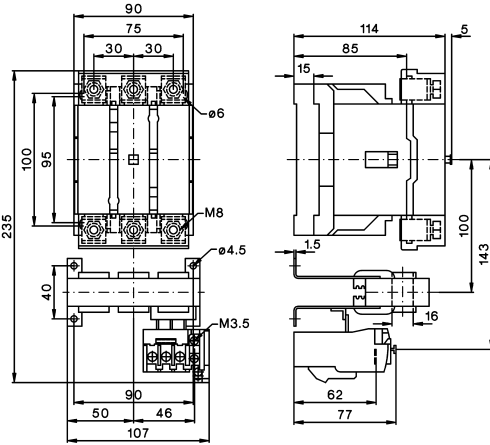

J7KN-150 + J7TKN-F
J7KN-175

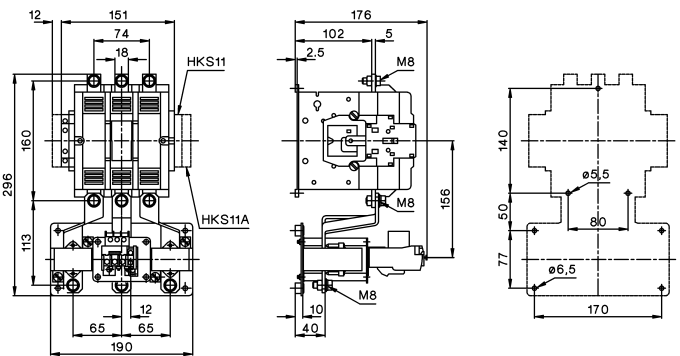

J7KN-200 + J7TKN-210

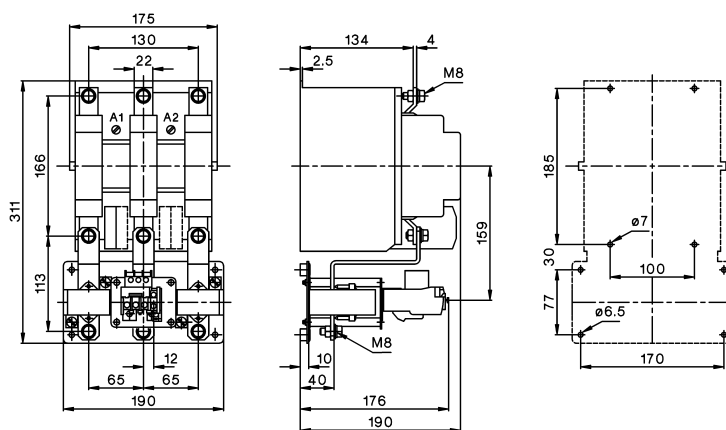

ALL DIMENSIONS SHOWN ARE IN MILLIMETERS.

To convert millimeters into inches, multiply by 0.03937. To convert grams into ounces, multiply by 0.03527.