

Brief Description

The ZSPM9000 DrMOS is a fully optimized, ultra-compact, integrated MOSFET plus driver power-stage solution for high-current, high-frequency, synchronous buck DC-DC applications. The device incorporates a driver IC, two power MOSFETs, and a bootstrap Schottky diode in a thermally enhanced, ultra-compact 6mmx6mm PQFN40 package.

With an integrated approach, the ZSPM9000's complete switching power stage is optimized for driver and MOSFET dynamic performance, system inductance, and power MOSFET $R_{DS(ON)}$. It uses innovative high-performance MOSFET technology, which dramatically reduces switch ringing, eliminating the snubber circuit in most buck converter applications.

An innovative driver IC with reduced dead times and propagation delays further enhances performance. An internal 12V to 5V linear regulator enables the ZSPM9000 to operate from a single 12V supply. A thermal warning function (THWN) warns of potential over-temperature situations. The ZSPM9000 also incorporates features such as Skip Mode (SMOD) for improved light-load efficiency and a tri-state 3.3V pulse-width modulation (PWM) input for compatibility with a wide range of PWM controllers.

The ZSPM9000 DrMOS is ideally compatible with IDT's ZSPM1000, a leading-edge configurable digital power-management system controller for non-isolated point-of-load (POL) supplies.

Benefits

- Fully optimized system efficiency: >93% peak
- Clean switching waveforms with minimal ringing
- 72% space-saving compared to conventional discrete solutions
- Ideally compatible with IDT's ZSPM1000 true digital PWM controller

Features

- Based on the Intel® 4.0 DrMOS standard
- Internal 12V to 5V linear regulator (LDO)
- High-current handling: up to 50A
- High-performance copper-clip package
- Tri-state 3.3V PWM input driver
- Skip Mode (low-side gate turn off) input (SMOD#)
- Warning flag for over-temperature conditions
- Driver output disable function (DISB# pin)
- Internal pull-up and pull-down for SMOD# and DISB# inputs, respectively
- Integrated Schottky diode technology in the low-side MOSFET
- Integrated bootstrap Schottky diode
- Adaptive gate drive timing for shoot-through protection
- Under-voltage lockout (UVLO)
- Optimized for switching frequencies up to 1MHz

Available Support

- ZSPM8000-KIT: Closed Loop Evaluation Kit combined for the ZSPM9000 and ZSPM1000

Physical Characteristics

- Operation temperature: -40°C to +125°C
- V_{IN} : 8V to 15V (typical 12V)
- I_{OUT} : 40A (average), 50A (maximum)
- Low-profile SMD package: 6mmx6mm PQFN40
- IDT green packaging and RoHS compliant

Typical Application

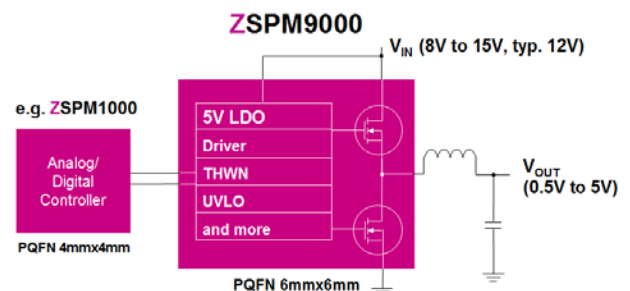

ZSPM9000 Block Diagram

- Typical Applications**
- Telecom switches
 - Servers and storage
 - Desktop computers
 - Workstations
 - High-performance gaming motherboards
 - Base stations
 - Network routers
 - Industrial applications

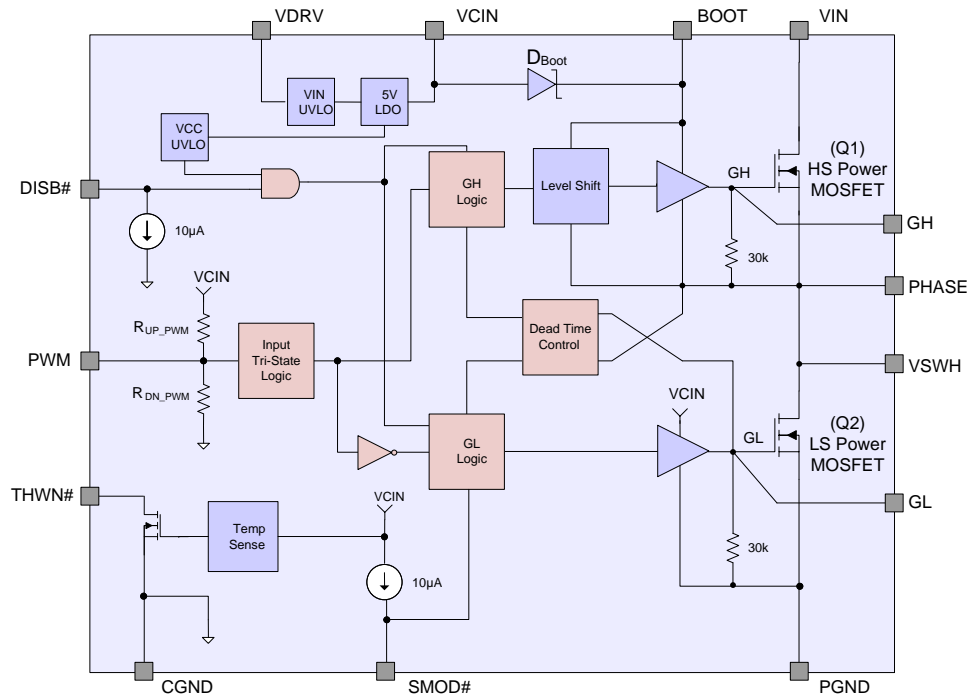

Ordering Information

Product Sales Code	Description	Package
ZSPM9000A11R	ZSPM9000 Lead-free PQFN40 — Temperature range: -40°C to +125°C	Reel
ZSPM8000-KIT	Integrated Evaluation Kit for ZSPM9000 and ZSPM1000	Kit



Corporate Headquarters
6024 Silver Creek Valley Road
San Jose, CA 95138
www.IDT.com

Sales
1-800-345-7015 or 408-284-8200
Fax: 408-284-2775
www.IDT.com/go/sales

Tech Support
www.IDT.com/go/support

DISCLAIMER Integrated Device Technology, Inc. (IDT) reserves the right to modify the products and/or specifications described herein at any time, without notice, at IDT's sole discretion. Performance specifications and operating parameters of the described products are determined in an independent state and are not guaranteed to perform the same way when installed in customer products. The information contained herein is provided without representation or warranty of any kind, whether express or implied, including, but not limited to, the suitability of IDT's products for any particular purpose, an implied warranty of merchantability, or non-infringement of the intellectual property rights of others. This document is presented only as a guide and does not convey any license under intellectual property rights of IDT or any third parties.

IDT's products are not intended for use in applications involving extreme environmental conditions or in life support systems or similar devices where the failure or malfunction of an IDT product can be reasonably expected to significantly affect the health or safety of users. Anyone using an IDT product in such a manner does so at their own risk, absent an express, written agreement by IDT.

Integrated Device Technology, IDT and the IDT logo are trademarks or registered trademarks of IDT and its subsidiaries in the United States and other countries. Other trademarks used herein are the property of IDT or their respective third party owners. For datasheet type definitions and a glossary of common terms, visit www.idt.com/go/glossary. All contents of this document are copyright of Integrated Device Technology, Inc. All rights reserved.

Contents

List of Figures	3
List of Tables	4
1 IC Characteristics	5
1.1. Absolute Maximum Ratings	5
1.2. Recommended Operating Conditions	6
1.3. Electrical Parameters	6
1.4. Typical Performance Characteristics	9
2 Functional Description	14
2.1. VDRV and Disable (DISB#)	15
2.2. Thermal Warning Flag (THWN#)	16
2.3. Tri-state PWM Input	16
2.4. Adaptive Gate Drive Circuit	17
2.5. Skip Mode (SMOD#)	18
2.6. PWM	20
3 Application Design	21
3.1. 5V Linear Regulator Capacitor Selection	21
3.2. Bootstrap Circuit	21
3.3. Power Loss and Efficiency Testing Procedures	21
4 Pin Configuration and Package	23
4.1. Available Packages	23
4.2. Pin Description	24
4.3. Package Dimensions	25
5 Circuit Board Layout Considerations	26
6 Ordering Information	28
7 Related Documents	28
8 Document Revision History	28

List of Figures

Figure 1.1 Safe Operating Area	9
Figure 1.2 Module Power Loss vs. Output Current	9
Figure 1.3 Power Loss vs. Switching Frequency	9
Figure 1.4 Power Loss vs. Input Voltage	9
Figure 1.5 Power Loss vs. Driver Supply Voltage	10
Figure 1.6 Power Loss vs. Output Voltage	10
Figure 1.7 Power Loss vs. Output Inductance	10
Figure 1.8 Driver Supply Current vs. Frequency	10
Figure 1.9 Driver Supply Current vs. Driver Supply Voltage	11
Figure 1.10 Driver Supply Current vs. Output Current	11

Figure 1.11	PWM Thresholds vs. Driver Supply Voltage.....	11
Figure 1.12	PWM Thresholds vs. Temperature.....	11
Figure 1.13	SMOD# Thresholds vs. Driver Supply Voltage.....	12
Figure 1.14	SMOD# Thresholds vs. Temperature.....	12
Figure 1.15	SMOD# Pull-Up Current vs. Temperature.....	12
Figure 1.16	Disable Thresholds vs. Driver Supply Voltage.....	12
Figure 1.17	Disable Thresholds vs. Temperature.....	13
Figure 1.18	Disable Pull-Down Current vs. Temperature.....	13
Figure 2.1	Typical Application Circuit with PWM Control.....	14
Figure 2.2	ZSPM9000 Block Diagram.....	15
Figure 2.3	THWN# Operation.....	16
Figure 2.4	PWM and Tri-state Timing Diagram.....	17
Figure 2.5	SMOD# Timing Diagram.....	19
Figure 2.6	PWM Timing.....	20
Figure 3.1	Power Loss Measurement Block Diagram.....	22
Figure 4.1	Pin-out PQFN40 Package.....	23
Figure 4.2	PQFN40 Physical Dimensions and Recommended Footprint.....	25
Figure 5.1	PCB Layout Example.....	27

List of Tables

Table 2.1	UVLO and Disable Logic.....	16
Table 2.2	SMOD# Logic.....	18

1 IC Characteristics

1.1. Absolute Maximum Ratings

The absolute maximum ratings are stress ratings only. The device might not function or be operable above the recommended operating conditions. Stresses exceeding the absolute maximum ratings might also damage the device. In addition, extended exposure to stresses above the recommended operating conditions might affect device reliability. IDT does not recommend designing to the “Absolute Maximum Ratings.”

PARAMETER	SYMBOL	CONDITIONS	MIN	MAX	UNITS
Maximum Voltage to CGND – VCIN, DISB#, PWM, SMOD#, GL, THWN# pins			-0.3	6.0	V
Maximum Voltage to PGND or CGND – VIN pin			-0.3	25.0	V
Maximum Voltage to PGND or CGND – VDRV pin				16.0	V
Maximum Voltage to VSWH or PHASE – BOOT, GH pins			-0.3	6.0	V
Maximum Voltage to CGND – BOOT, PHASE, GH pins			-0.3	25.0	V
Maximum Voltage to CGND/PGND – VSWH pin		DC only	-0.3	25.0	V
Maximum Voltage to PGND – VSWH pin		< 20ns	-8.0	25.0	V
Maximum Voltage to VCIN – BOOT pin				22.0	V
Maximum Sink Current – THWN# pin	$I_{THWN\#}$		-0.1	7.0	mA
Maximum Average Output Current ¹⁾	$I_{OUT(AV)}$	$f_{SW}=350kHz, V_{IN}=12V, V_{OUT}=1.0V$		45	A
		$f_{SW}=1MHz, V_{IN}=12V, V_{OUT}=1.0V$		42	A
Junction-to-PCB Thermal Resistance	θ_{JPCB}			3.5	°C/W
Ambient Temperature Range	T_{AMB}		-40	+125	°C
Maximum Junction Temperature	T_{jMAX}			+150	°C
Storage Temperature Range	T_{STOR}		-55	+150	°C
Electrostatic Discharge Protection	ESD	Human Body Model, JESD22-A114	2000		V
		Charged Device Model, JESD22-C101	1000		V
1) $I_{OUT(AV)}$ is rated using DrMOS Evaluation Board, $T_{AMB} = 25^{\circ}C$, natural convection cooling. This rating is limited by the peak DrMOS temperature, $T_{jMAX} = 150^{\circ}C$, and varies depending on operating conditions, PCB layout, and PCB board to ambient thermal resistance.					

1.2. Recommended Operating Conditions

The “Recommended Operating Conditions” table defines the conditions for actual device operation. Recommended operating conditions are specified to ensure optimal performance to the datasheet specifications. IDT does not recommend exceeding them or designing to the “Absolute Maximum Ratings.”

PARAMETER	SYMBOL	CONDITIONS	MIN	TYP	MAX	UNITS
Gate Drive Circuit Supply Voltage	V_{DRV}		8	12	15	V
Output Stage Supply Voltage	V_{IN}		3	12	15	V

1.3. Electrical Parameters

Typical values are $V_{IN} = 12V$, $V_{DRV} = 12V$, and $T_{AMB} = +25^{\circ}C$ unless otherwise noted.

PARAMETER	SYMBOL	CONDITIONS	MIN	TYP	MAX	UNITS
Basic Operation						
Quiescent Current	I_Q	$I_Q = I_{VDRV}$, PWM=LOW or HIGH or float		2	5	mA
Internal 5V Linear Regulator						
Input Current	I_{VDRV}	$8V < V_{DRV} < 14V$, $f_{SW} = 1MHz$		36		mA
Output Voltage	V_{CIN}	$V_{DRV} = 8V$, $I_{LOAD} = 5mA$	4.8	5.0	5.2	V
Power Dissipation	P_{VDRV}	$V_{DRV} = 12V$, $f_{SW} = 1MHz$		250		mW
VCIN Bypass Capacitor	C_{VCIN}	X7R or X5R Ceramic	1		10	μF
Line Regulation		$8V < V_{DRV} < 14V$, $I_{LOAD} = 5mA$		20		mV
Load Regulation		$V_{DRV} = 8V$, $5mA < I_{LOAD} < 100mA$		75		mV
Short-Circuit Current Limit		$8V < V_{DRV} < 14V$		200		mA
UVLO Threshold	UVLO	V_{DRV} rising	6.8	7.3	7.8	V
UVLO Hysteresis	UVLO_Hyst			435		mV
PWM Input						
Pull-Up Impedance	R_{UP_PWM}			26		k Ω
Pull-Down Impedance	R_{DN_PWM}			12		k Ω
PWM High-Level Voltage	V_{IH_PWM}		2.01	2.25	2.48	V
Tri-state Upper Threshold	V_{TRI_HI}		1.96	2.20	2.44	V
Tri-state Lower Threshold	V_{TRI_LO}		0.76	0.95	1.14	V
PWM Low-Level Voltage	V_{IL_PWM}		0.67	0.85	1.08	V
Tri-state Shutoff Time	$t_{D_HOLD-OFF}$			160	200	ns
Tri-state Open Voltage	V_{HIz_PWM}		1.4	1.6	1.9	V

PARAMETER	SYMBOL	CONDITIONS	MIN	TYP	MAX	UNITS
DISB# Input						
High-Level Input Voltage	$V_{IH_DISB\#}$		2			V
Low-Level Input Voltage	$V_{IL_DISB\#}$				0.8	V
Pull-Down Current	I_{PLD}			10		μ A
Propagation Delay DISB#, GL Transition from HIGH to LOW	t_{PD_DISBL}	PWM=GND, LSE=1		25		ns
Propagation Delay DISB#, GL Transition from LOW to HIGH	t_{PD_DISBH}	PWM=GND, LSE=1		25		ns
SMOD# Input						
High-Level Input Voltage	$V_{IH_SMOD\#}$		2			V
Low-Level Input Voltage	$V_{IL_SMOD\#}$				0.8	V
Pull-Up Current	I_{PLU}			10		μ A
Propagation Delay SMOD#, GL Transition from HIGH to LOW	t_{PD_SLGLL}	PWM=GND, DISB#=1		10		ns
Propagation Delay SMOD#, GL Transition from LOW to HIGH	t_{PD_SHGLH}	PWM=GND, DISB#=1		10		ns
Thermal Warning Flag						
Activation Temperature	T_{ACT}			150		$^{\circ}$ C
Reset Temperature	T_{RST}			135		$^{\circ}$ C
Pull-Down Resistance	R_{THWN}	$I_{PLD}=5\text{mA}$		30		Ω
250ns Timeout Circuit						
Timeout Delay Between GH Transition from HIGH to LOW and GL Transition from LOW to HIGH	$t_{D_TIMEOUT}$	VSWH =0V		250		ns

PARAMETER	SYMBOL	CONDITIONS	MIN	TYP	MAX	UNITS
High-Side Driver						
Output Impedance, Sourcing	R _{SOURCE_GH}	Source Current=100mA		1		Ω
Output Impedance, Sinking	R _{SINK_GH}	Sink Current=100mA		0.8		Ω
Rise Time for GH=10% to 90%	t _{R_GH}			6		ns
Fall Time for GH=90% to 10%	t _{F_GH}			5		ns
LS to HS Deadband Time: GL going LOW to GH going HIGH, 1V GL to 10% GH	t _{D_DEADON}			10		ns
PWM LOW Propagation Delay: PWM going LOW to GH going LOW, V _{IL_PWM} to 90% GH	t _{PD_PLGHL}			16	30	ns
PWM HIGH Propagation Delay with SMOD# Held LOW: PWM going HIGH to GH going HIGH, V _{IH_PWM} to 10% GH	t _{PD_PHGHH}	SMOD# = LOW		30		ns
Propagation Delay Exiting Tri-state: PWM (from Tri-state) going HIGH to GH going HIGH, V _{IH_PWM} to 10% GH	t _{PD_TSGHH}			30		ns
Low-Side Driver						
Output Impedance, Sourcing	R _{SOURCE_GL}	Source Current=100mA		1		Ω
Output Impedance, Sinking	R _{SINK_GL}	Sink Current=100mA		0.5		Ω
Rise Time for GL = 10% to 90%	t _{R_GL}			20		ns
Fall Time for GL = 90% to 10%	t _{F_GL}			13		ns
HS to LS Deadband Time: SW going LOW to GL going HIGH, 2.2V SW to 10% GL	t _{D_DEADOFF}			12		ns
PWM-HIGH Propagation Delay: PWM going HIGH to GL going LOW, V _{IH_PWM} to 90% GL	t _{PD_PHGLL}			9	25	ns
Propagation Delay Exiting Tri-state: PWM (from Tri-state) going LOW to GL going HIGH, V _{IL_PWM} to 10% GL	t _{PD_TSGLH}			20		ns
Boot Diode						
Forward-Voltage Drop	V _F	I _F =10mA		0.35		V
Breakdown Voltage	V _R	I _R =1mA	22			V

1.4. Typical Performance Characteristics

Test conditions: $V_{IN}=12V$, $V_{OUT}=1.0V$, $V_{CIN}=5V$, $V_{DRV}=5V$, $L_{OUT}=320nH$, $T_{AMB}=25^{\circ}C$, and natural convection cooling, unless otherwise specified.

Figure 1.1 Safe Operating Area

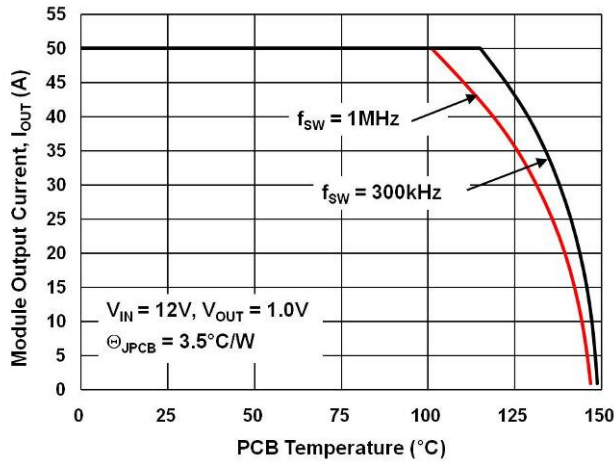

Figure 1.2 Module Power Loss vs. Output Current

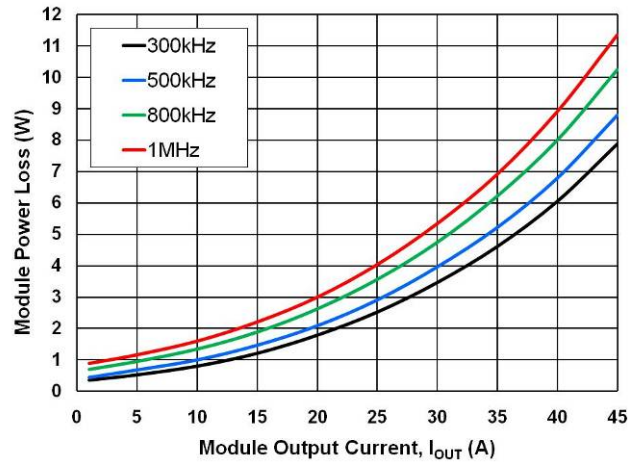

Figure 1.3 Power Loss vs. Switching Frequency

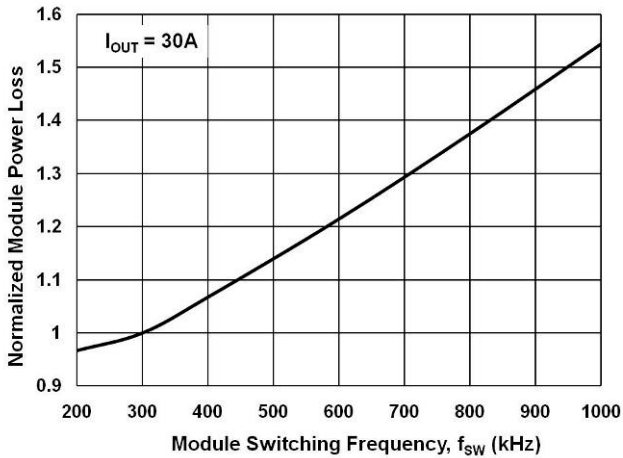

Figure 1.4 Power Loss vs. Input Voltage

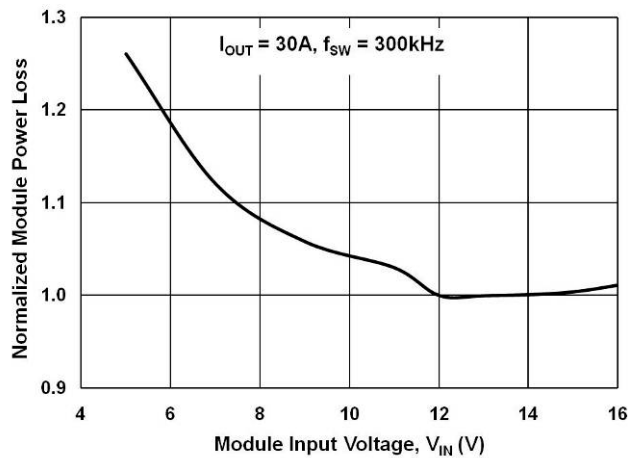

Figure 1.5 Power Loss vs. Driver Supply Voltage

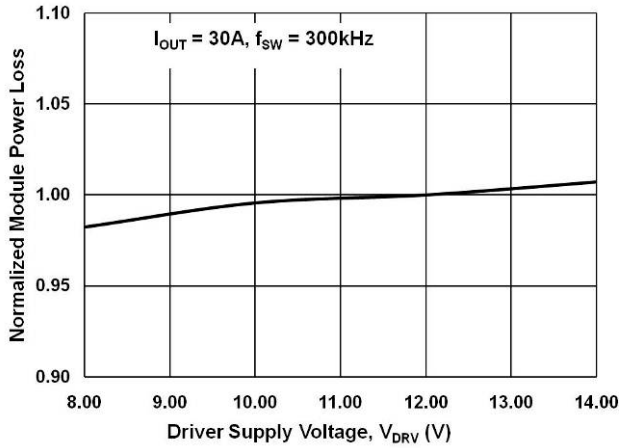

Figure 1.6 Power Loss vs. Output Voltage

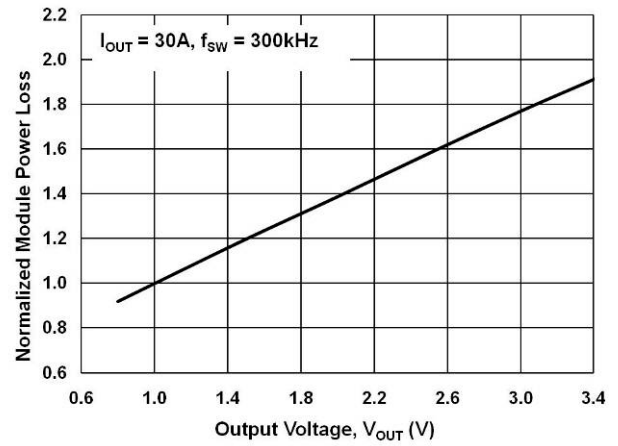

Figure 1.7 Power Loss vs. Output Inductance

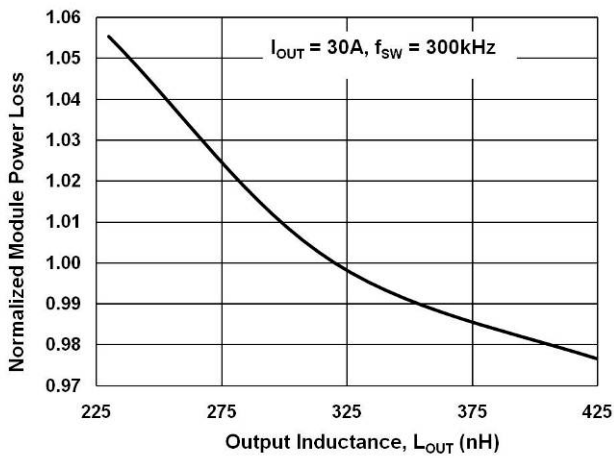

Figure 1.8 Driver Supply Current vs. Frequency

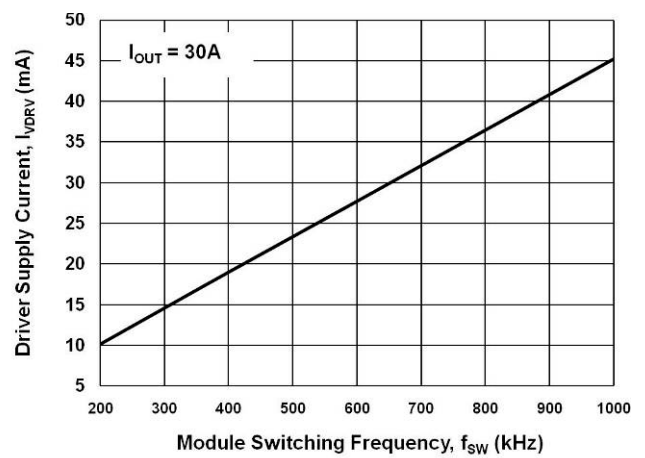

Figure 1.9 Driver Supply Current vs. Driver Supply Voltage

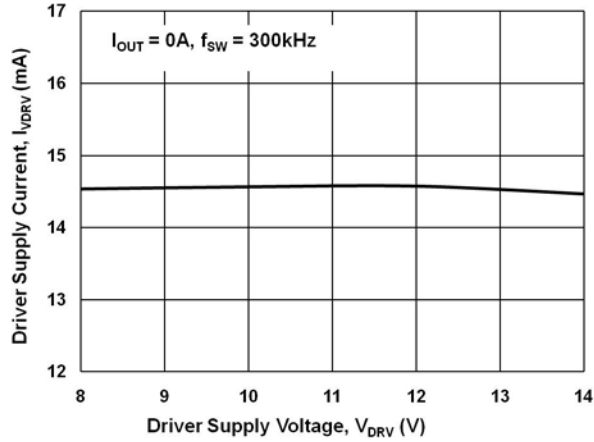

Figure 1.10 Driver Supply Current vs. Output Current

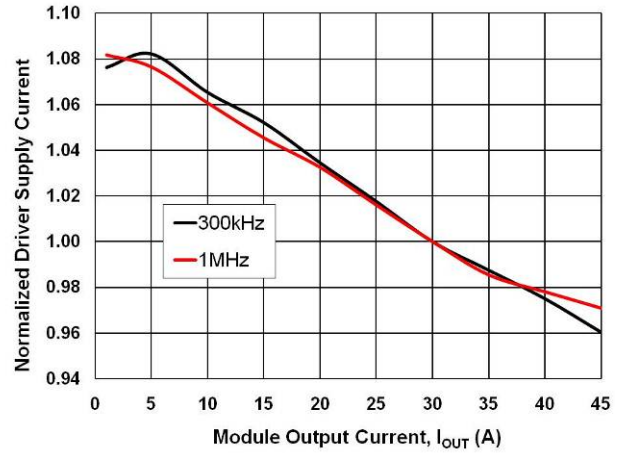

Figure 1.11 PWM Thresholds vs. Driver Supply Voltage

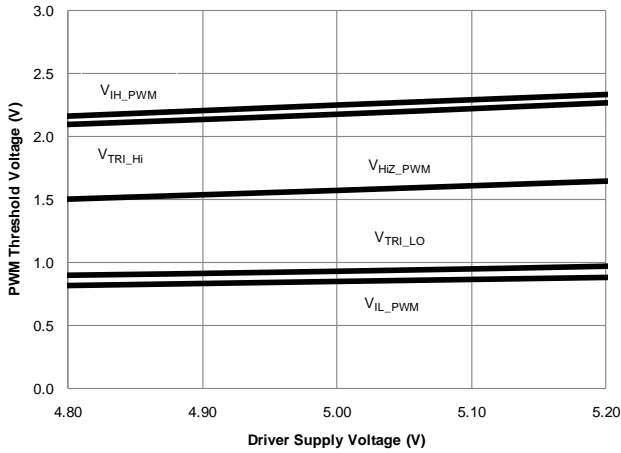

Figure 1.12 PWM Thresholds vs. Temperature

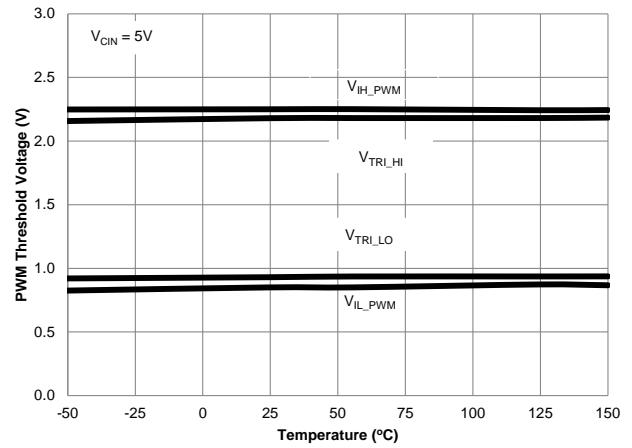

Figure 1.13 SMOD# Thresholds vs. Driver Supply Voltage

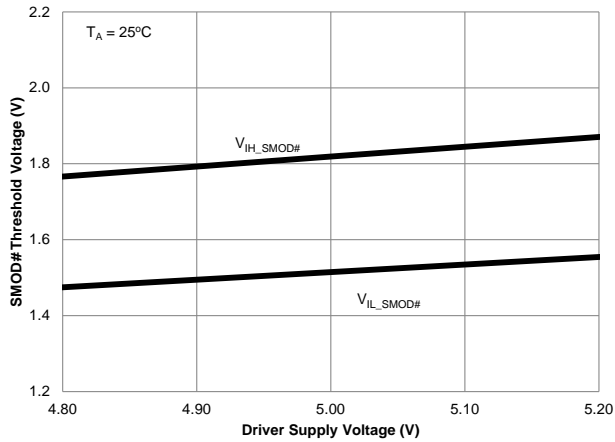

Figure 1.14 SMOD# Thresholds vs. Temperature

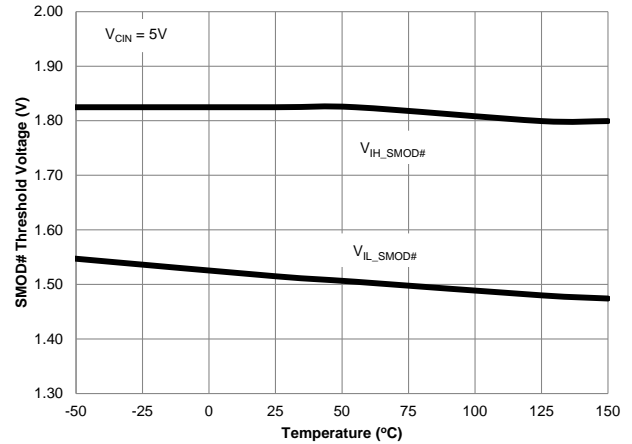

Figure 1.15 SMOD# Pull-Up Current vs. Temperature

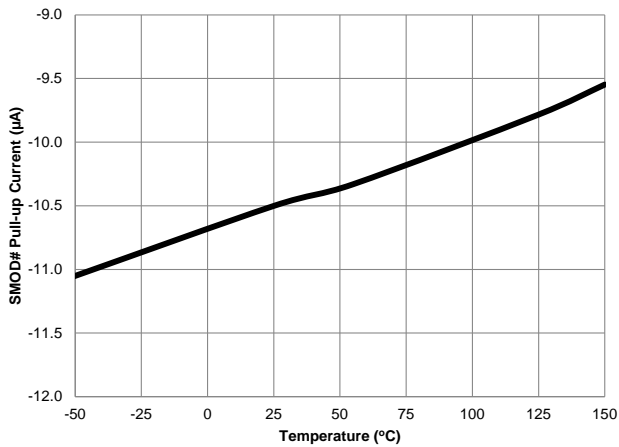

Figure 1.16 Disable Thresholds vs. Driver Supply Voltage

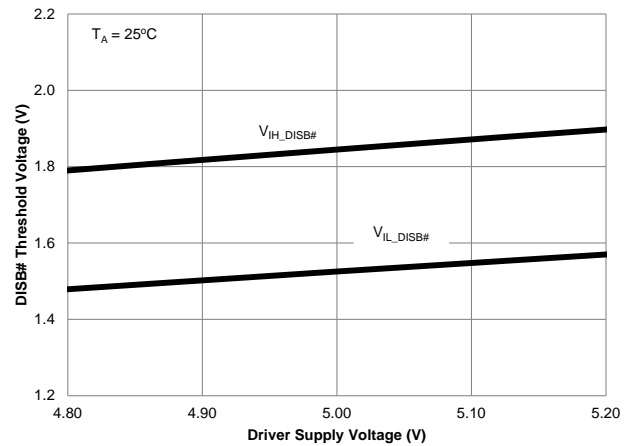

Figure 1.17 Disable Thresholds vs. Temperature

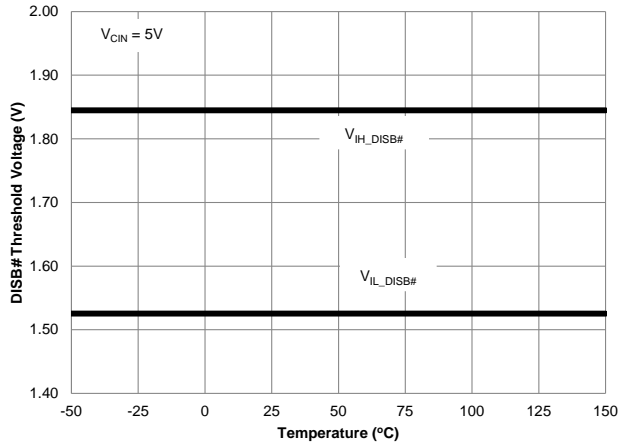
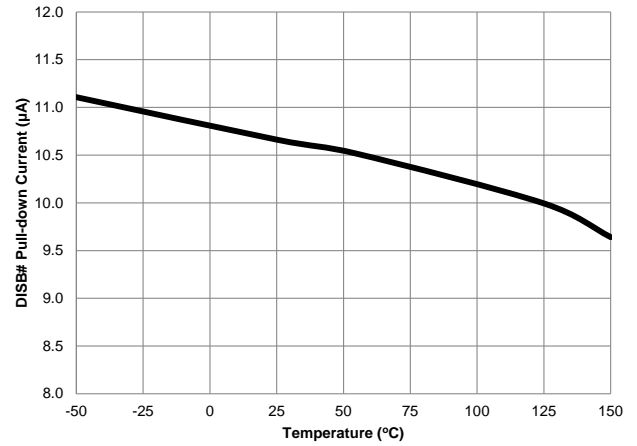

Figure 1.18 Disable Pull-Down Current vs. Temperature



2 Functional Description

The ZSPM9000 is a driver-plus-FET module optimized for the synchronous buck converter topology. A single PWM input signal is all that is required to properly drive the high-side and the low-side MOSFETs. It is capable of driving speeds up to 1MHz.

Figure 2.1 Typical Application Circuit with PWM Control

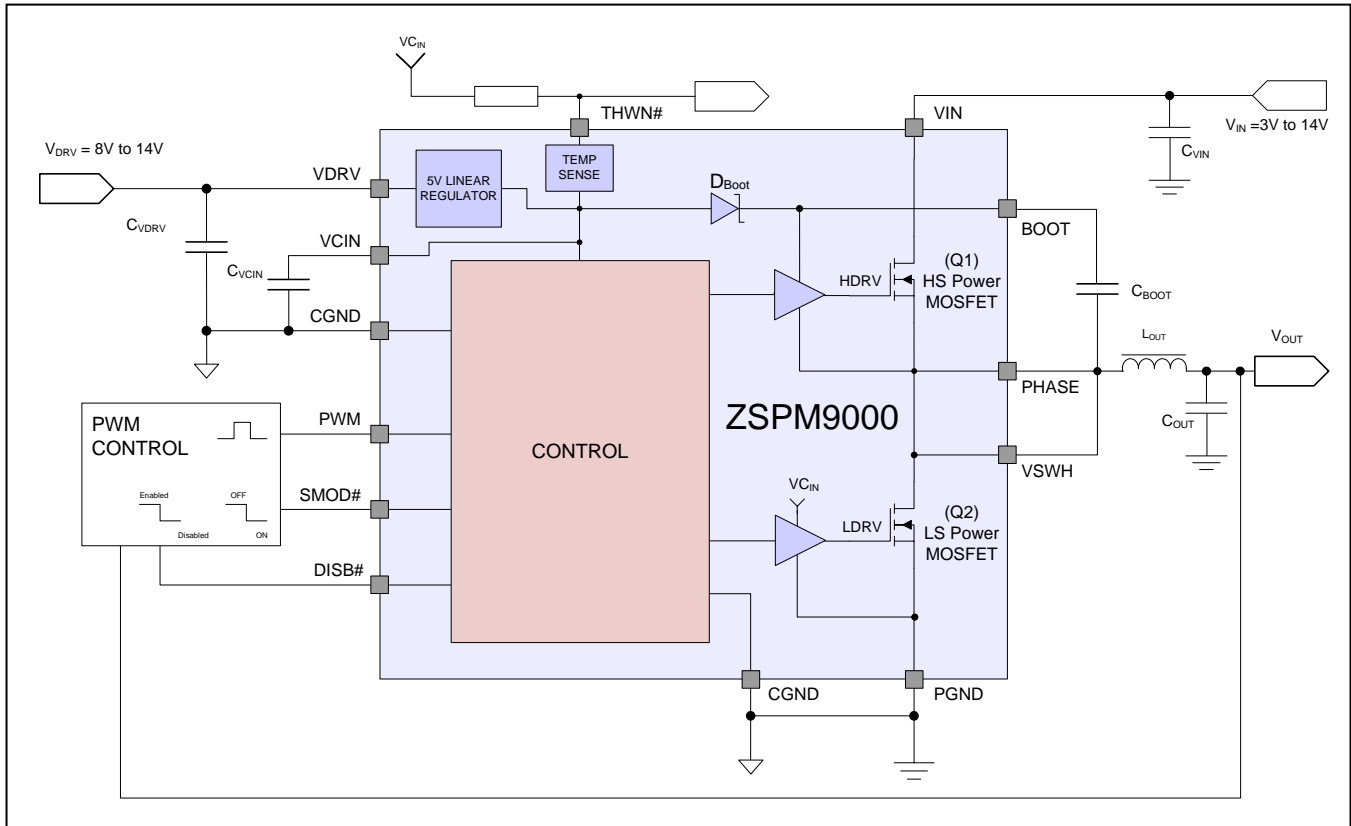
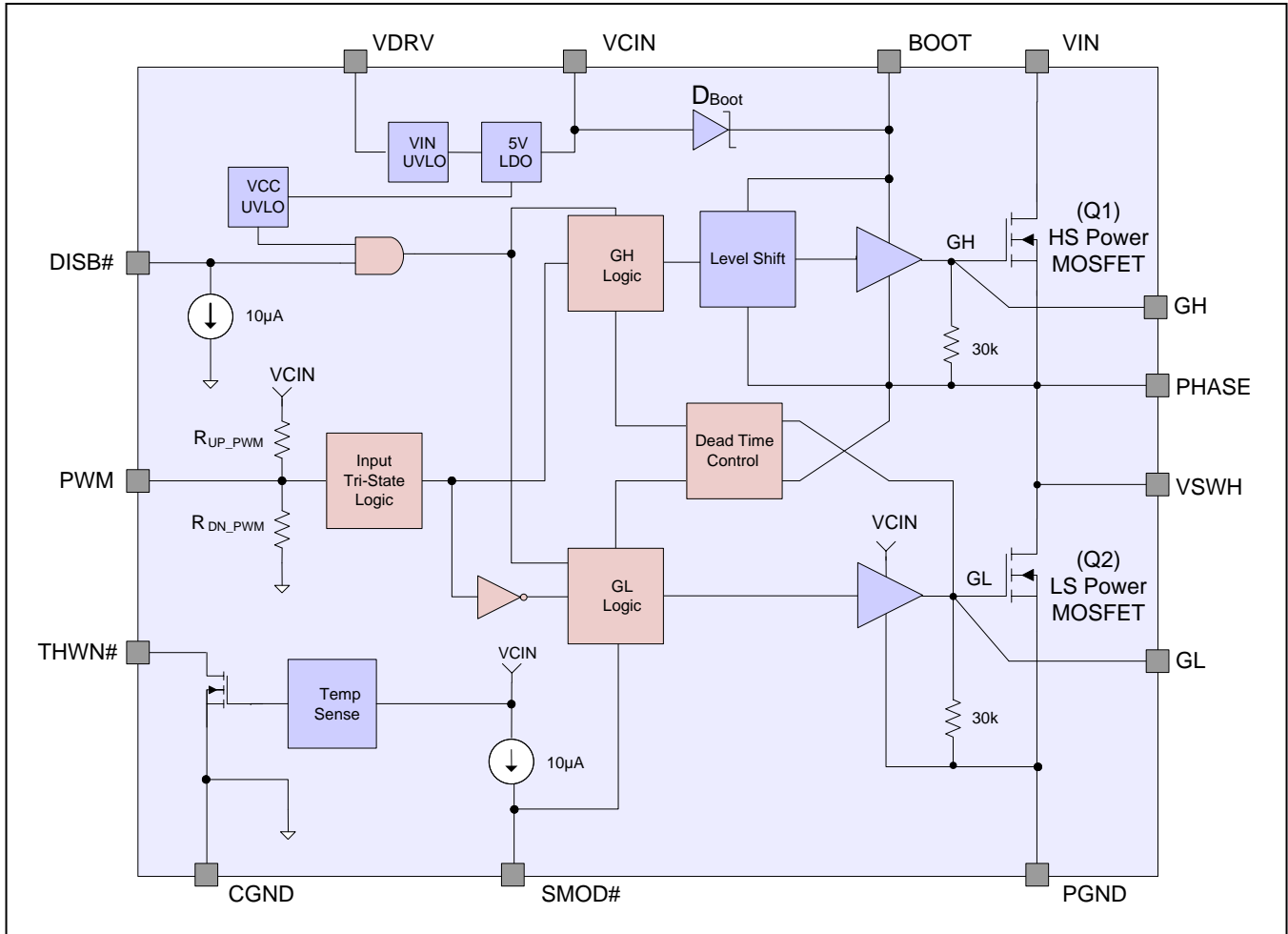

Figure 2.2 ZSPM9000 Block Diagram



2.1. VDRV and Disable (DISB#)

The VDRV pin is monitored by an under-voltage lockout (UVLO) circuit. When VDRV rises above ~7.5V, the driver is enabled. When VDRV falls below ~7.0V, the driver is disabled (GH, GL= 0; see Figure 2.2 and section 4.2). The driver can also be disabled by pulling the DISB# pin LOW (DISB# < V_{IL_DISB#}), which holds both GL and GH LOW regardless of the PWM input state. The driver can be enabled by raising the DISB# pin voltage HIGH (DISB# > V_{IH_DISB#}).

Table 2.1 UVLO and Disable Logic

Note: DISB# internal pull-down current source is 10 μ A (typical).

UVLO	DISB#	Driver State
0	X	Disabled (GH=0, GL=0)
1	0	Disabled (GH=0, GL=0)
1	1	Enabled (see Table 2.2)
1	Open	Disabled (GH=0, GL=0)

2.2. Thermal Warning Flag (THWN#)

The ZSPM9000 provides a thermal warning flag (THWN#) to indicate over-temperature conditions. The thermal warning flag uses an open-drain output that pulls to CGND when the activation temperature (150°C) is reached. The THWN# output returns to the high-impedance state if the temperature falls to the reset temperature (135°C). For use, the THWN# output requires a pull-up resistor, which can be connected to VCIN. Note that THWN# does NOT disable the DrMOS module.

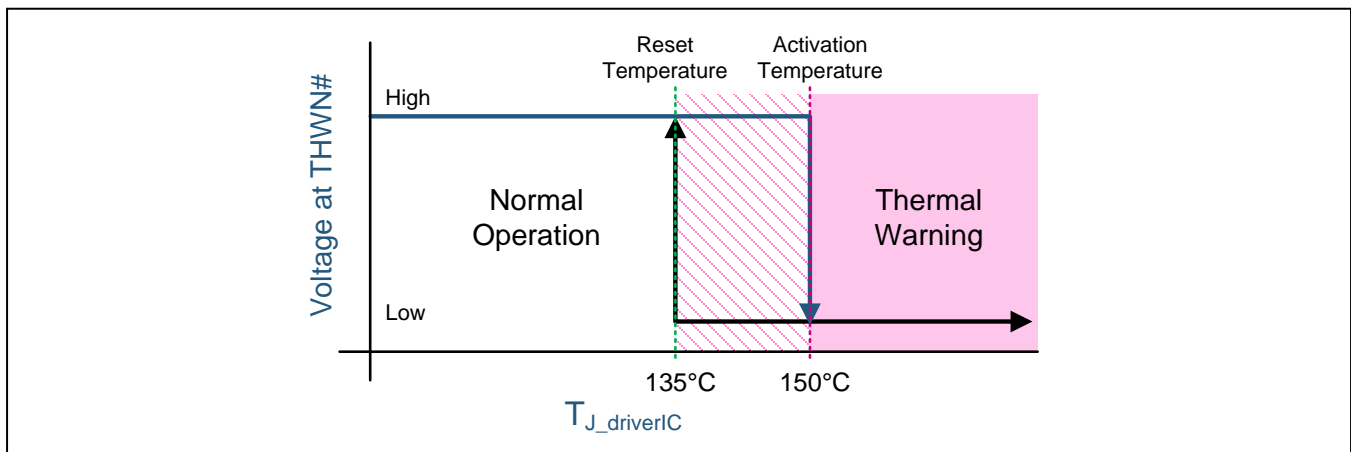
Figure 2.3 THWN# Operation

2.3. Tri-state PWM Input

The ZSPM9000 incorporates a tri-state 3.3V PWM input gate drive design. The tri-state gate drive has a logic HIGH level, logic LOW level, and a tri-state shutdown voltage window. When the PWM input signal enters and remains within the tri-state voltage window for a defined hold-off time ($t_{D_HOLD-OFF}$), both GL and GH are pulled LOW. This feature enables the gate drive to shut down both high and low side MOSFETs using only one control signal. For example, this can be used for phase shedding in multi-phase voltage regulators.

When exiting a valid tri-state condition, the ZSPM9000 follows the PWM input command. If the PWM input goes from tri-state to LOW, the low-side MOSFET is turned on. If the PWM input goes from tri-state to HIGH, the high-side MOSFET is turned on, as illustrated in Figure 2.4. The ZSPM9000's design allows for short propagation delays when exiting the tri-state window (see section 1.3).

Figure 2.4 PWM and Tri-state Timing Diagram

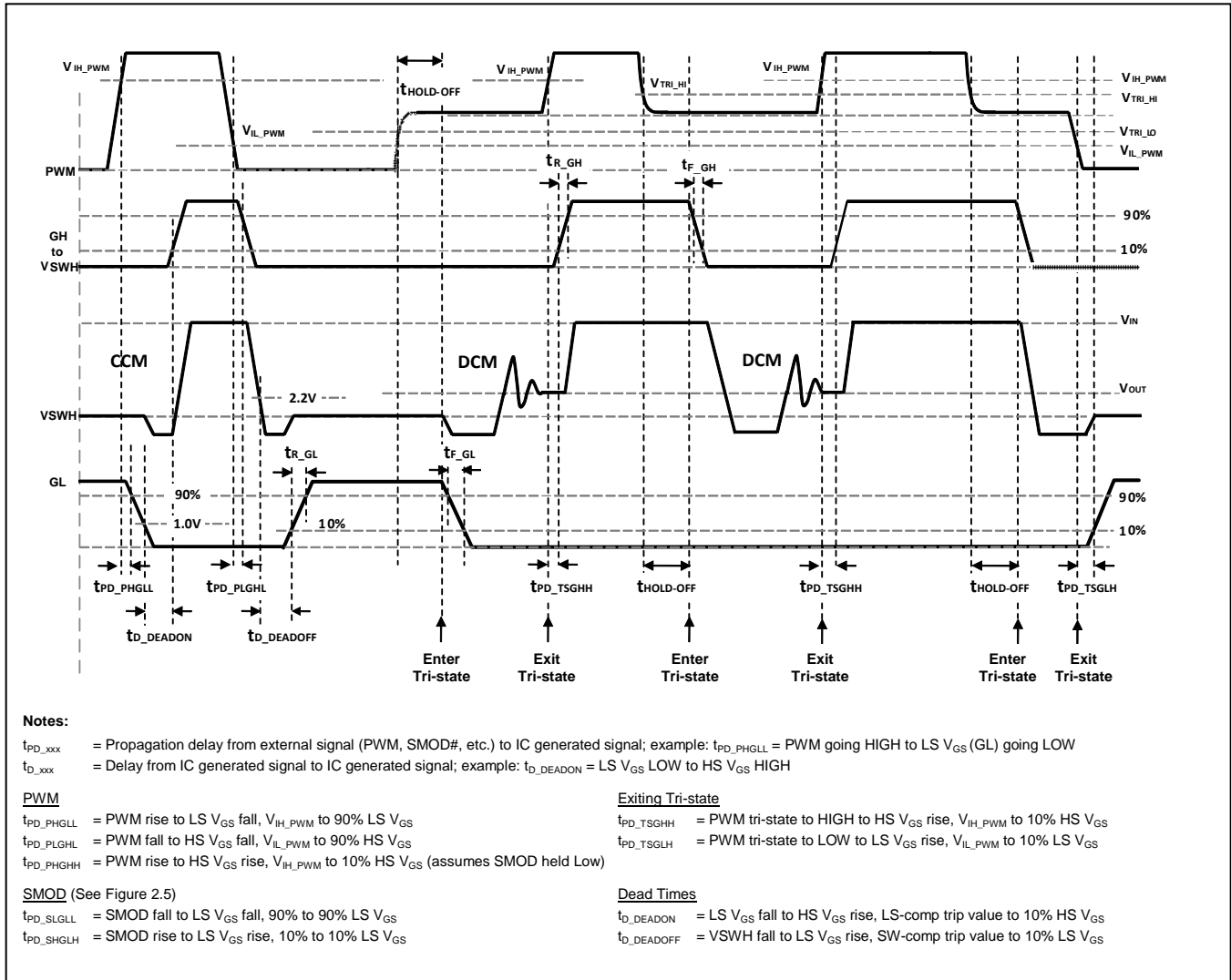

2.4. Adaptive Gate Drive Circuit

The low-side driver (GL) is designed to drive the ground-referenced low $R_{DS(ON)}$ N-channel MOSFET (Q2). The bias for GL is internally connected between VDRV and CGND. When the driver is enabled, the driver's output is 180° out of phase with the PWM input. When the driver is disabled (DISB#=0V), GL is held LOW.

The high-side driver (GH) is designed to drive a floating N-channel MOSFET (Q1). The bias voltage for the high-side driver is developed by a bootstrap supply circuit consisting of the internal Schottky diode and external bootstrap capacitor (C_{BOOT}). During startup, the VSWH pin is held at PGND, allowing C_{BOOT} (see section 3.2) to charge to V_{DRV} through the internal diode. When the PWM input goes HIGH, GH begins to charge the gate of the high-side MOSFET (Q1). During this transition, the charge is removed from C_{BOOT} and delivered to the gate of Q1. As Q1 turns on, V_{SWH} rises to V_{IN} , forcing the BOOT pin to $V_{IN} + V_{BOOT}$, which provides sufficient V_{GS} enhancement for Q1. To complete the switching cycle, Q1 is turned off by pulling GH to V_{SWH} . C_{BOOT} is then

recharged to V_{DRV} when V_{SWH} falls to PGND. The GH output is in-phase with the PWM input. The high-side gate is held LOW when the driver is disabled or the PWM signal is held within the tri-state window for longer than the tri-state hold-off time, $t_{D_HOLD-OFF}$ (see Figure 2.4).

The driver IC design ensures minimum MOSFET dead time while eliminating potential shoot-through (cross-conduction) currents. It senses the state of the MOSFETs and adjusts the gate drive adaptively to prevent simultaneous conduction. Figure 2.4 provides the relevant timing waveforms. To prevent overlap during the LOW-to-HIGH switching transition (Q2 off to Q1 on), the adaptive circuitry monitors the voltage at the GL pin. When the PWM signal goes HIGH, Q2 begins to turn off after a propagation delay (t_{PD_PHGLL}). Once the GL pin is discharged below $\sim 1V$, Q1 begins to turn on after adaptive delay t_{D_DEADON} .

To prevent overlap during the HIGH-to-LOW transition (Q1 off to Q2 on), the adaptive circuitry monitors the voltage at the VSWH pin. When the PWM signal goes LOW, Q1 begins to turn off after a propagation delay (t_{PD_PLGHL}). Once the VSWH pin falls below approx. 2.2V, Q2 begins to turn on after adaptive delay $t_{D_DEADOFF}$. $V_{GS(Q1)}$ is also monitored. When $V_{GS(Q1)}$ is discharged below approx. 1.2V, a secondary adaptive delay is initiated that results in Q2 being driven on after $t_{D_TIMEOUT}$, regardless of VSWH state. This function is implemented to ensure C_{BOOT} is recharged each switching cycle in the event that the VSWH voltage does not fall below the 2.2V adaptive threshold. Secondary delay $t_{D_TIMEOUT}$ is longer than $t_{D_DEADOFF}$.

2.5. Skip Mode (SMOD#)

The SMOD function allows higher converter efficiency under light-load conditions. During SMOD, the low-side FET gate signal is disabled (held LOW), preventing discharging of the output capacitors as the filter inductor current attempts reverse current flow – also known as Diode Emulation Mode.

When the SMOD# pin is pulled HIGH, the synchronous buck converter works in Synchronous Mode. This mode allows gating on the low-side FET. When the SMOD# pin is pulled LOW, the low-side FET is gated off. If the SMOD# pin is connected to the PWM controller, the controller can actively enable or disable SMOD when the controller detects light-load operation.

Table 2.2 SMOD# Logic

Note: The SMOD feature is intended to have a low propagation delay between the SMOD signal and the low-side FET V_{GS} response time to control diode emulation on a cycle-by-cycle basis.

DISB#	PWM	SMOD#	GH	GL
0	X	X	0	0
1	Tri-state	X	0	0
1	0	0	0	0
1	1	0	1	0
1	0	1	0	1
1	1	1	1	0

Figure 2.5 SMOD# Timing Diagram

See Figure 2.4 for the definitions of the timing parameters.

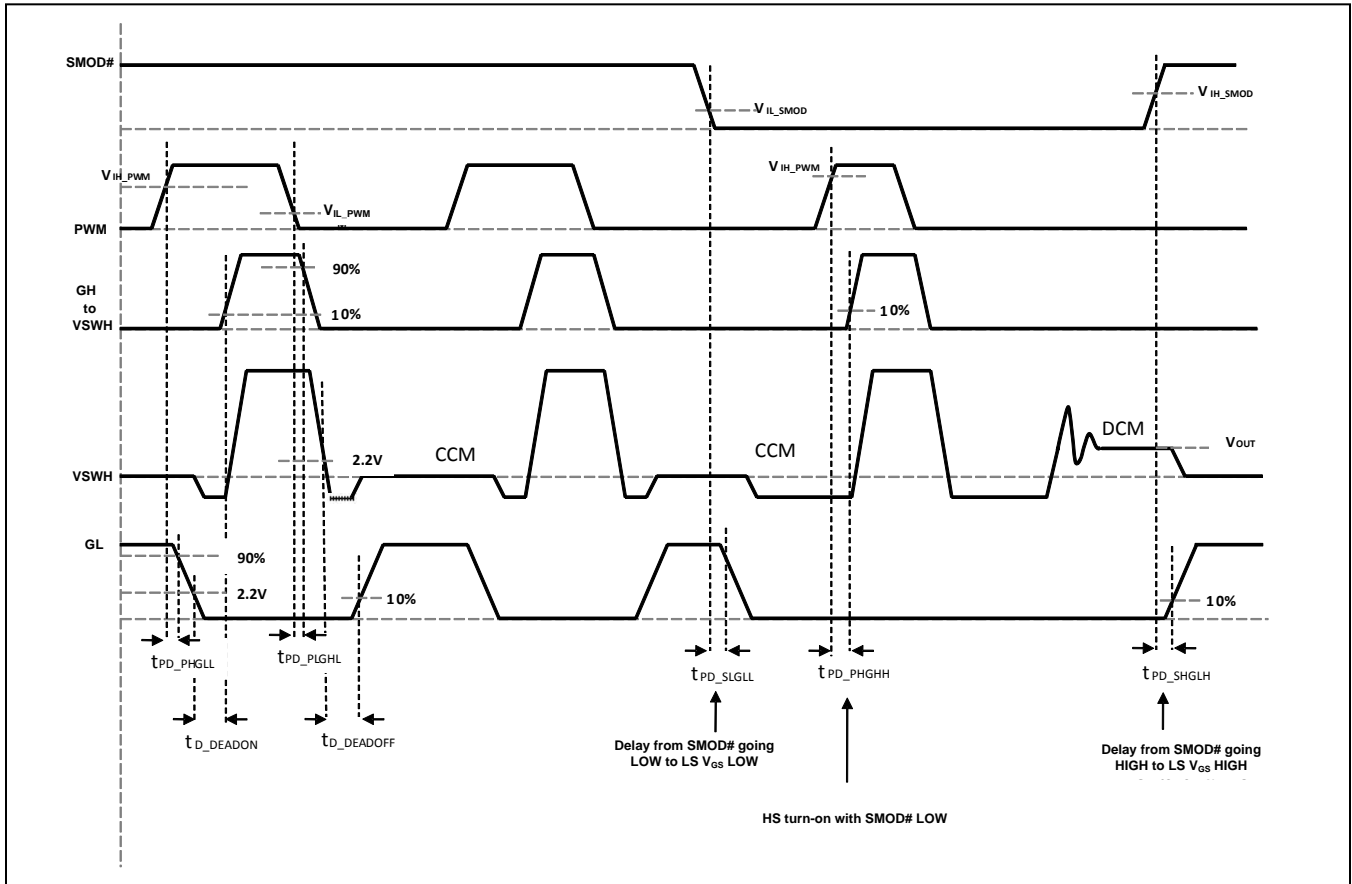

2.6. PWM

Figure 2.6 PWM Timing

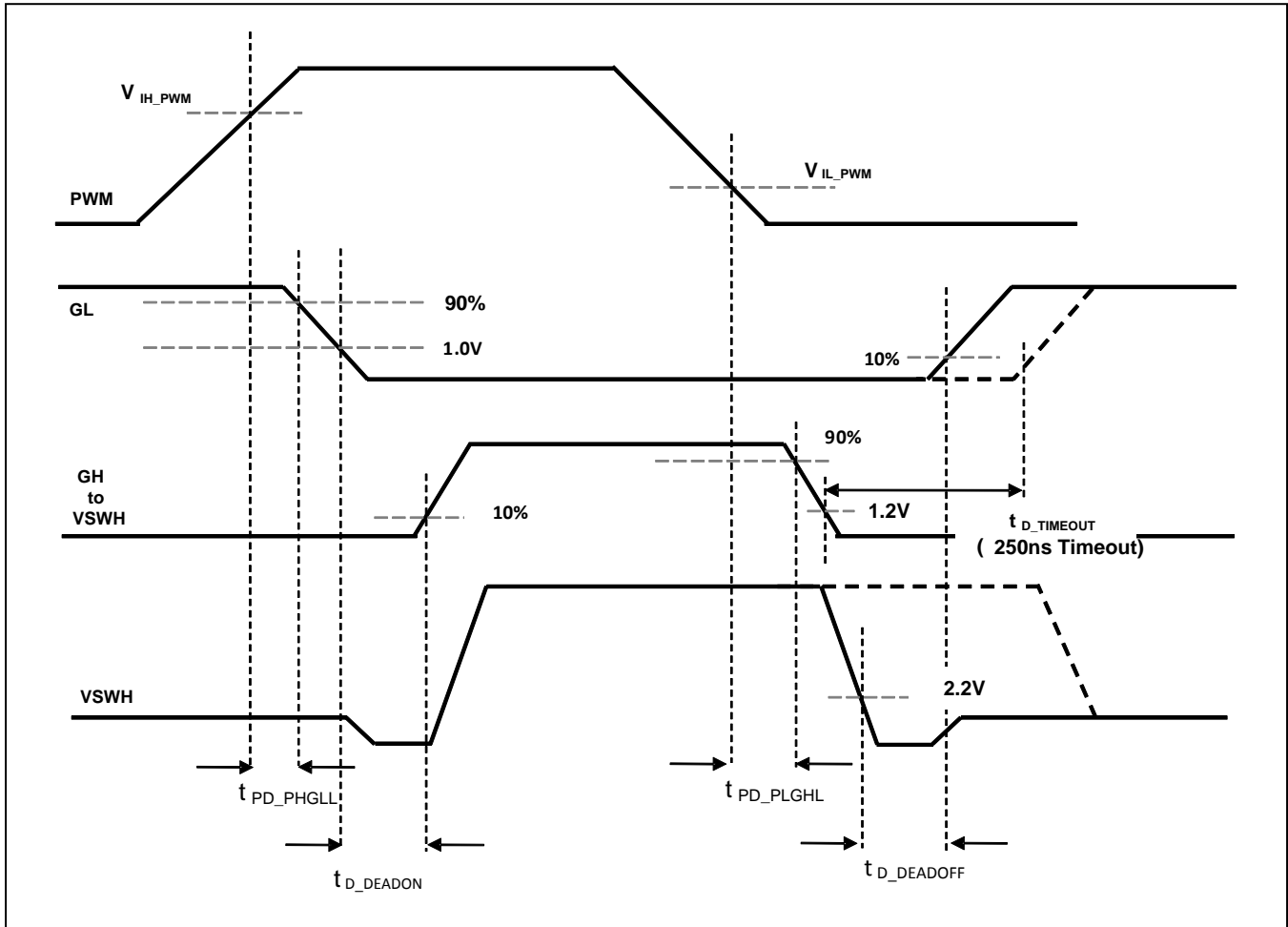

3 Application Design

3.1. 5V Linear Regulator Capacitor Selection

For the linear regulator output (VCIN), a local ceramic bypass capacitor is required for linear regulator stability. This capacitor is also needed to reduce noise and is used to supply the peak power MOSFET low-side gate current and boot capacitor charging current. Use at least a 1 μ F capacitor with an X7R or X5R dielectric. Keep this capacitor close to the VCIN pin and connect it to the CGND ground plane with vias. A 1 μ F bypass capacitor with an X7R or X5R dielectric is also recommended from VDRV to CGND.

3.2. Bootstrap Circuit

The bootstrap circuit uses a charge storage capacitor (C_{BOOT}), as shown in Figure 3.1. A bootstrap capacitance of 100nF using an X7R or X5R capacitor is typically adequate. A series bootstrap resistor may be needed for specific applications to improve switching noise immunity. The boot resistor may be required when operating near the maximum rated V_{IN} and is effective at controlling the high-side MOSFET turn-on slew rate and V_{SWH} overshoot. Typical R_{BOOT} values from 0.5 Ω to 2.0 Ω are effective in reducing V_{SWH} overshoot.

3.3. Power Loss and Efficiency Testing Procedures

The circuit in Figure 3.1 has been used to measure power losses. The efficiency has been calculated based on the equations below.

Power loss calculations:

$$P_{IN} = (V_{IN} * I_{IN}) + (V_{5V} * I_{5V}) \quad (1)$$

$$P_{SW} = (V_{SW} * I_{OUT}) \quad (2)$$

$$P_{OUT} = (V_{OUT} * I_{OUT}) \quad (3)$$

$$P_{LOSS_MODULE} = (P_{IN} - P_{SW}) \quad (4)$$

$$P_{LOSS_BOARD} = (P_{IN} - P_{OUT}) \quad (5)$$

Efficiency calculations:

$$EFF_{MODULE} = \left(100 * \frac{P_{SW}}{P_{IN}} \right) \% \tag{6}$$

$$EFF_{BOARD} = \left(100 * \frac{P_{OUT}}{P_{IN}} \right) \% \tag{7}$$

Figure 3.1 Power Loss Measurement Block Diagram

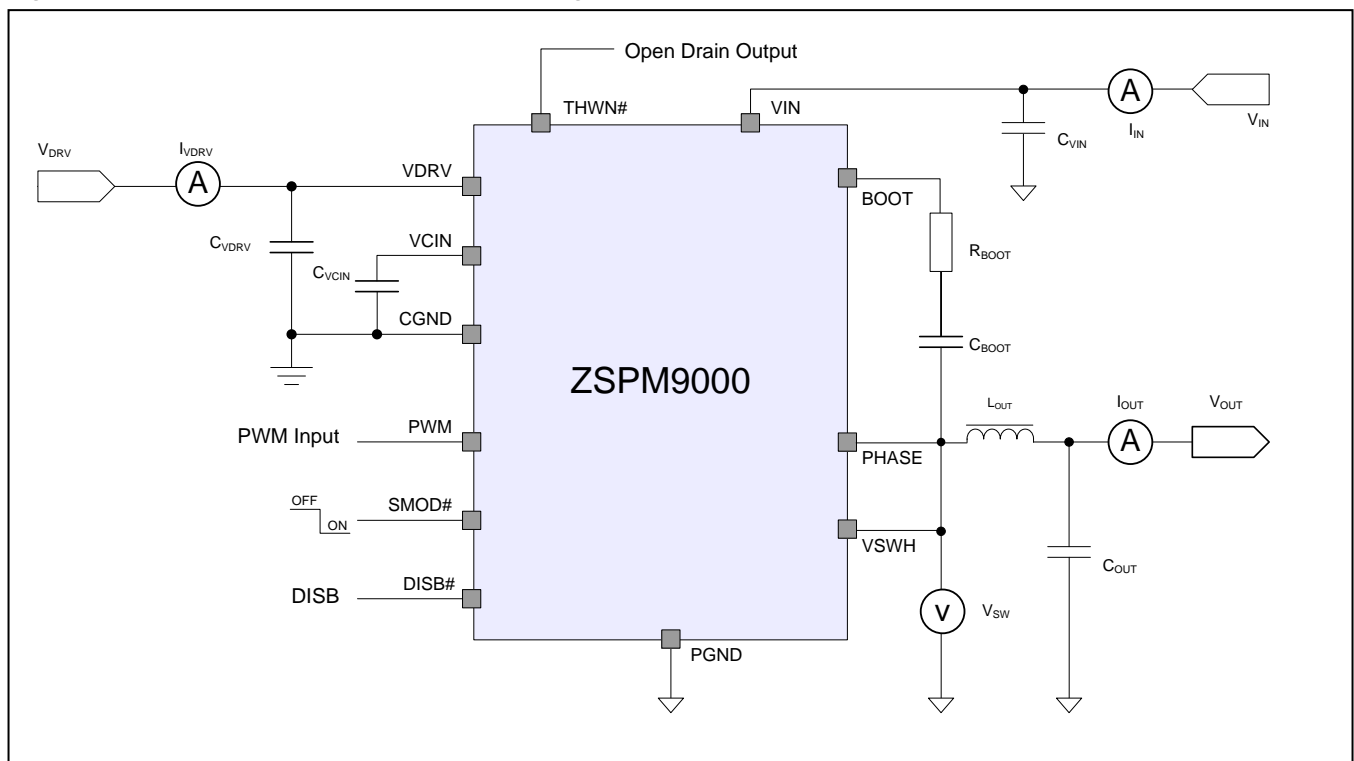

4 Pin Configuration and Package

4.1. Available Packages

The ZSPM9000 is available in a 40-lead clip-bond PQFN package. The pin-out is shown in Figure 4.1. See Figure 4.2 for the mechanical drawing of the package.

Figure 4.1 Pin-out PQFN40 Package

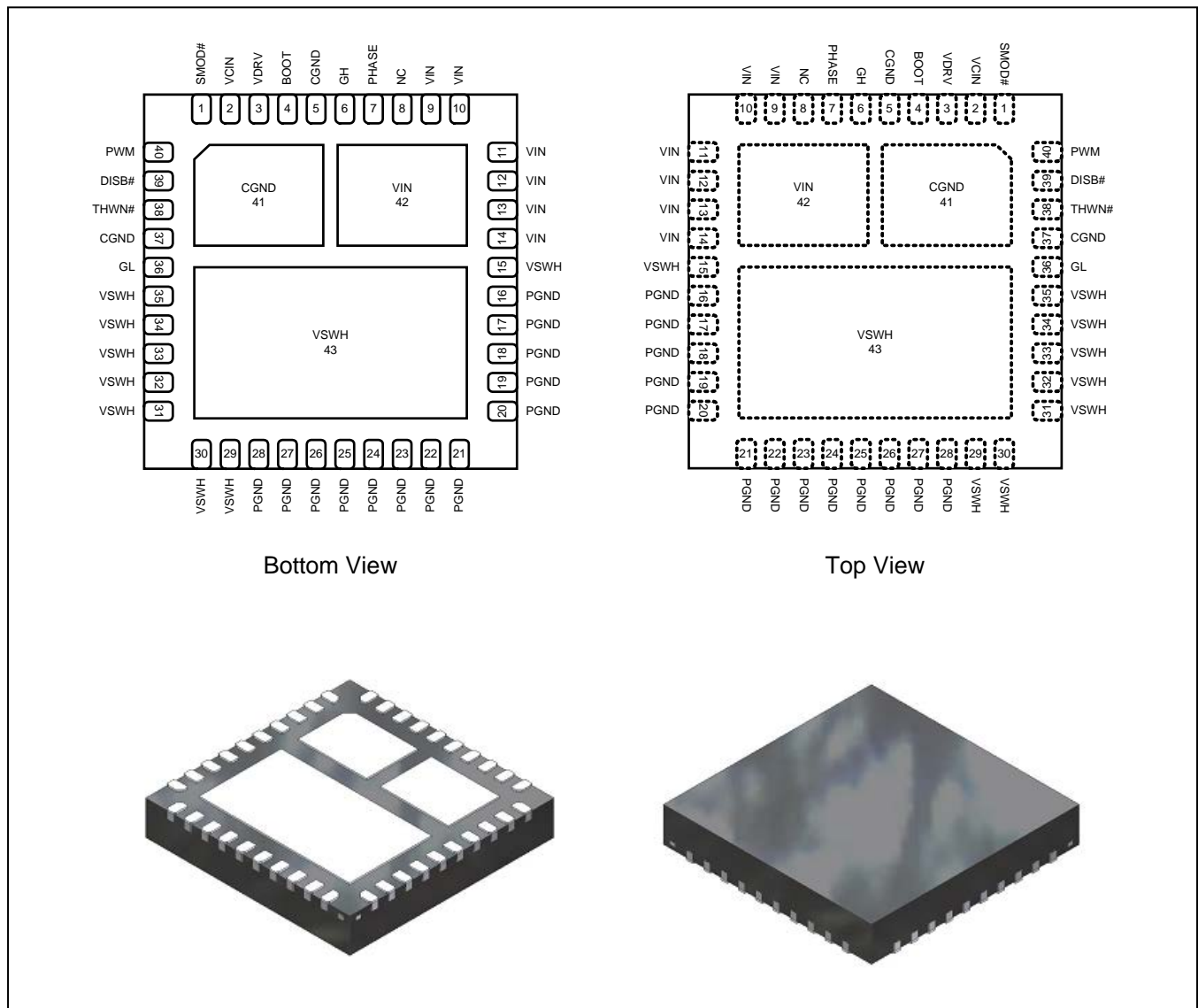

4.2. Pin Description

Pin	Name	Description
1	SMOD#	When SMOD#=HIGH, the low-side driver is the inverse of PWM input. When SMOD#=LOW, the low-side driver is disabled. This pin has a 10 μ A internal pull-up current source. Do not add a noise filter capacitor.
2	VCIN	Linear regulator 5V output. Minimum 1 μ F X5R/X7R ceramic capacitor to CGND is required.
3	VDRV	Linear regulator input. Minimum 1 μ F X5R/X7R ceramic capacitor to CGND is required.
4	BOOT	Bootstrap supply input. Provides voltage supply to the high-side MOSFET driver. Connect a bootstrap capacitor from this pin to PHASE.
5, 37, 41	CGND	Ground return for driver IC.
6	GH	Gate high. For manufacturing test only. This pin must float: it must not be connected.
7	PHASE	Switch node pin for bootstrap capacitor routing; electrically shorted to VSWH pin.
8	NC	No connection. The pin is not electrically connected internally but can be connected to VIN for convenience.
9 - 14, 42	VIN	Input power voltage (output stage supply voltage).
15, 29 - 35, 43	VSWH	Switch node. Provides return for high-side bootstrapped driver and acts as a sense point for the adaptive shoot-through protection.
16 - 28	PGND	Power ground (output stage ground). Source pin of the low-side MOSFET.
36	GL	Gate low. For manufacturing test only. This pin must float. It must not be connected.
38	THWN#	Thermal warning flag, open collector output. When temperature exceeds the trip limit, the output is pulled LOW. THWN# does not disable the module.
39	DISB#	Output disable. When LOW, this pin disables the power MOSFET switching (GH and GL are held LOW). This pin has a 10 μ A internal pull-down current source. Do not add a noise filter capacitor.
40	PWM	PWM signal input. This pin accepts a tri-state 3.3V PWM signal from the controller.

5 Circuit Board Layout Considerations

Figure 5.1 provides an example of a proper layout for the ZSPM9000 and critical components. All of the high-current paths, such as VIN, VSWH, VOUT, and GND copper traces, should be short and wide for low inductance and resistance. This technique achieves a more stable and evenly distributed current flow with enhanced heat radiation and system performance.

The following guidelines are recommendations for the printed circuit board (PCB) designer:

1. Input ceramic bypass capacitors must be placed close to the VIN and PGND pins. This helps reduce the high-current power loop inductance and the input current ripple induced by the power MOSFET switching operation.
2. The VSWH copper trace serves two purposes. In addition to being the high-frequency current path from the DrMOS package to the output inductor, it also serves as a heat sink for the low-side MOSFET in the DrMOS package. The trace should be short and wide enough to present a low-impedance path for the high-frequency, high-current flow between the DrMOS and inductor to minimize losses and temperature rise. Note that the VSWH node is a high-voltage and high-frequency switching node with high noise potential. Care should be taken to minimize coupling to adjacent traces. Since this copper trace also acts as a heat sink for the lower FET, balance using the largest area possible to improve DrMOS cooling while maintaining acceptable noise emission.
3. An output inductor should be located close to the ZSPM9000 to minimize the power loss due to the VSWH copper trace. Care should also be taken so the inductor dissipation does not heat the DrMOS.
4. The power MOSFETs used in the output stage are effective at minimizing ringing due to fast switching. In most cases, no VSWH snubber is required. If a snubber is used, it should be placed close to the VSWH and PGND pins. The resistor and capacitor must be the proper size for the power dissipation.
5. VCIN, VDRV, and BOOT capacitors should be placed as close as possible to the respective pins to ensure clean and stable power. Routing width and length should be considered as well.
6. Include a trace from PHASE to VSWH to improve the noise margin. Keep the trace as short as possible.
7. The layout should include a placeholder to insert a small-value series boot resistor (R_{BOOT}) between the boot capacitor (C_{BOOT}) and DrMOS BOOT pin. The BOOT-to-VSWH loop size, including R_{BOOT} and C_{BOOT} , should be as small as possible. The boot resistor may be required when operating near the maximum rated V_{IN} . The boot resistor is effective at controlling the high-side MOSFET turn-on slew rate and VSWH overshoot. R_{BOOT} can improve the noise operating margin in synchronous buck designs that might have noise issues due to ground bounce or high positive and negative VSWH ringing. However, inserting a boot resistance lowers the DrMOS efficiency. Efficiency versus noise trade-offs must be considered. R_{BOOT} values from 0.5 Ω to 2.0 Ω are typically effective in reducing VSWH overshoot.
8. The VIN and PGND pins handle large current transients with frequency components greater than 100MHz. If possible, these pins should be connected directly to the VIN and board GND planes. The use of thermal relief traces in series with these pins is discouraged since this adds inductance to the power path. Added inductance in series with the VIN or PGND pin degrades system noise immunity by increasing positive and negative VSWH ringing.
9. CGND pad and PGND pins should be connected to the GND plane copper with multiple vias for stable grounding. Poor grounding can create a noise transient offset voltage level between CGND and PGND. This could lead to faulty operation of the gate driver and MOSFETs.

10. Ringing at the BOOT pin is most effectively controlled by close placement of the boot capacitor. Do not add a capacitor from BOOT to ground; this may lead to excess current flow through the BOOT diode.
11. The SMOD# and DISB# pins have weak internal pull-up and pull-down current sources, respectively. Do NOT float these pins if avoidable. These pins should not have any noise filter capacitors.
12. Use multiple vias on each copper area to interconnect top, inner, and bottom layers to help distribute current flow and heat conduction. Vias should be relatively large and of reasonably low inductance. Critical high-frequency components, such as R_{BOOT} , C_{BOOT} , the RC snubber, and bypass capacitors should be located as close to the respective DrMOS module pins as possible on the top layer of the PCB. If this is not feasible, they should be connected from the backside through a network of low-inductance vias.

Figure 5.1 PCB Layout Example

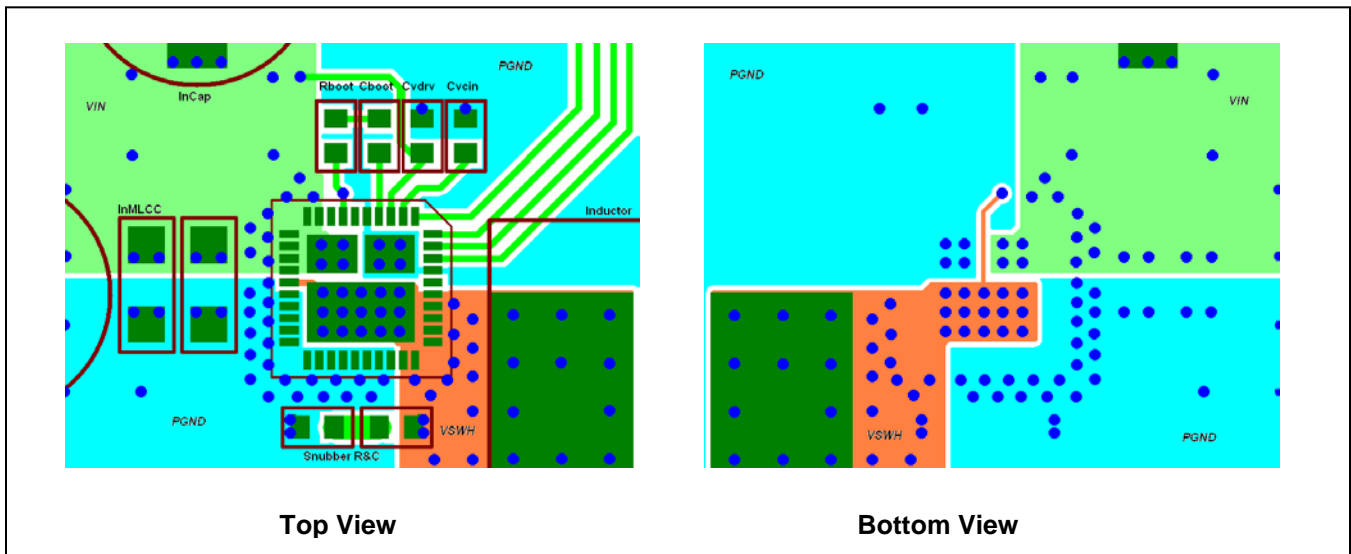

6 Ordering Information

Product Sales Code	Description	Package
ZSPM9000A11R	ZSPM9000 Lead-free PQFN40 — Temperature range: -40°C to +125°C	Reel
ZSPM8000-KIT	Integrated Evaluation Kit for ZSPM9000 and ZSPM1000	Kit

7 Related Documents

Document
ZSPM8000-KIT Evaluation Kit Description

Visit IDT's website www.IDT.com or contact your nearest sales office for the latest version of these documents.

8 Document Revision History

Revision	Date	Description
1.00	September 22, 2011	First release
1.01	March 12, 2012	Minor edits to text and figures. Update for IDT contact information.
1.02	November 19, 2012	Minor edits. Update for IDT contact information.
1.03	March 8, 2013	Updates for cover and header imagery and contact table.
	January 27, 2016	Changed to IDT branding.



Corporate Headquarters
6024 Silver Creek Valley Road
San Jose, CA 95138
www.IDT.com

Sales
1-800-345-7015 or 408-284-8200
Fax: 408-284-2775
www.IDT.com/go/sales

Tech Support
www.IDT.com/go/support

DISCLAIMER Integrated Device Technology, Inc. (IDT) reserves the right to modify the products and/or specifications described herein at any time, without notice, at IDT's sole discretion. Performance specifications and operating parameters of the described products are determined in an independent state and are not guaranteed to perform the same way when installed in customer products. The information contained herein is provided without representation or warranty of any kind, whether express or implied, including, but not limited to, the suitability of IDT's products for any particular purpose, an implied warranty of merchantability, or non-infringement of the intellectual property rights of others. This document is presented only as a guide and does not convey any license under intellectual property rights of IDT or any third parties.

IDT's products are not intended for use in applications involving extreme environmental conditions or in life support systems or similar devices where the failure or malfunction of an IDT product can be reasonably expected to significantly affect the health or safety of users. Anyone using an IDT product in such a manner does so at their own risk, absent an express, written agreement by IDT.

Integrated Device Technology, IDT and the IDT logo are trademarks or registered trademarks of IDT and its subsidiaries in the United States and other countries. Other trademarks used herein are the property of IDT or their respective third party owners. For datasheet type definitions and a glossary of common terms, visit www.idt.com/go/glossary. All contents of this document are copyright of Integrated Device Technology, Inc. All rights reserved.