

Features

- 13A,500V, $R_{DS(on)}$ (Max0.49 Ω)@ $V_{GS}=10V$
- Ultra-low Gate charge(Typical 37nC)
- Fast Switching Capability
- 100%Avalanche Tested
- Maximum Junction Temperature Range(150 $^{\circ}C$)

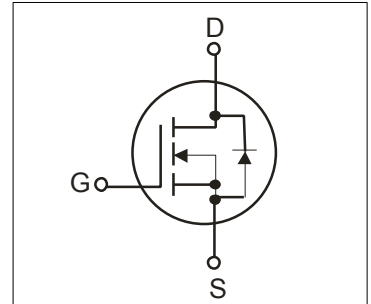

General Description

This Power MOSFET is produced using Winsemi's trench layout-based process. This technology improves the performances compared with standard parts from various sources. All of these power MOSFETs are designed for applications in switching regulators, switching convertors, motor and relay drivers, and drivers for high power bipolar switching transistors demanding high speed and low gate drive power.

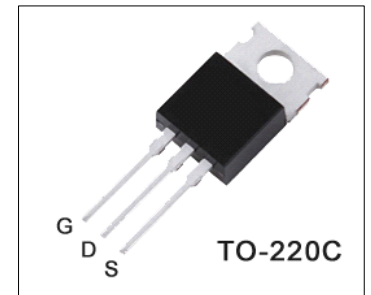

Absolute Maximum Ratings

Symbol	Parameter	Value	Units
V_{DSS}	Drain Source Voltage	500	V
I_D	Continuous Drain Current(@ $T_c=25^{\circ}C$)	13	A
	Continuous Drain Current(@ $T_c=100^{\circ}C$)	8	A
I_{DM}	Drain Current Pulsed (Note1)	52	A
V_{GS}	Gate to Source Voltage	± 30	V
E_{AS}	Single Pulsed Avalanche Energy (Note2)	845	mJ
I_{AR}	Avalanche Current (note 1)	13	A
E_{AR}	Repetitive Avalanche Energy (Note1)	5	mJ
dv/dt	Peak Diode Recovery dv /dt (Note3)	4.5	V/ ns
P_D	Total Power Dissipation(@ $T_c=25^{\circ}C$)	190	W
	Derating Factor above 25 $^{\circ}C$	1.56	W/ $^{\circ}C$
T_J, T_{stg}	Junction and Storage Temperature	-55~150	$^{\circ}C$
T_L	Channel Temperature	300	$^{\circ}C$

Thermal Characteristics

Symbol	Parameter	Value			Units
		Min	Typ	Max	
R_{QJC}	Thermal Resistance , Junction -to -Case	-	-	0.66	$^{\circ}C/W$
R_{QJA}	Thermal Resistance , Junction-to -Ambient	-	-	62.5	$^{\circ}C/W$

Electrical Characteristics(Tc=25°C)

Characteristics	Symbol	Test Condition	Min	Type	Max	Unit	
Gate leakage current	I _{GSS}	V _{GS} =±30V,V _{DS} =0V	-	-	±100	nA	
Gate-source breakdown voltage	V _{(BR)GSS}	I _G =±10 μA,V _{DS} =0V	±30	-	-	V	
Drain cut -off current	I _{DSS}	V _{DS} =500V,V _{GS} =0V	-	-	1	μA	
		V _{DS} =400V,TC=125°C			10	μA	
Drain -source breakdown voltage	V _{(BR)DSS}	I _D =250 μA,V _{GS} =0V	500	-	-	V	
Breakdown voltage Temperature Coefficient	ΔBV _{DSS} /ΔT _J	I _D =250μA,Referenced to 25°C	-	0.6	-	V/°C	
Gate threshold voltage	V _{GS(th)}	V _{DS} =10V,I _D =250 μA	2	-	4	V	
Drain -source ON resistance	R _{DS(ON)}	V _{GS} =10V,I _D =6.5A	-	0.37	0.49	Ω	
Forward Transconductance	g _{fs}	V _{DS} =40V,I _D =6.5A	-	15	-	S	
Input capacitance	C _{iss}	V _{DS} =25V,	-	1560	2090	pF	
Reverse transfer capacitance	C _{rss}	V _{GS} =0V,	-	25	30		
Output capacitance	C _{oss}	f=1MHz	-	210	260		
Switching time	Turn-On rise time	tr	V _{DD} =250V, I _D =13A R _G =25Ω (Note4,5)	-	160	270	ns
	Turn-On delay time	td(on)		-	90	180	
	Turn-Off Fall time	tf		-	60	140	
	Turn-Off delay time	td(off)		-	150	260	
Total gate charge(gate-source plus gate-drain)	Q _g	V _{DD} =400V, V _{GS} =10V,	-	37	50	nC	
Gate-source charge	Q _{gs}	I _D =13A	-	10.9	-		
Gate-drain("miller") Charge	Q _{gd}	(Note4,5)	-	17.2	-		

Source-Drain Ratings and Characteristics(Ta=25°C)

Characteristics	Symbol	Test Condition	Min	Type	Max	Unit
Continuous drain reverse current	I _{DR}	-	-	-	13	A
Pulse drain reverse current	I _{DRP}	-	-	-	52	A
Forward voltage(diode)	V _{DSF}	I _{DR} =13A,V _{GS} =0V	-	-	1.5	V
Reverse recovery time	trr	I _{DR} =13A,V _{GS} =0V,	-	410	-	ns
Reverse recovery charge	Q _{rr}	di _{DR} / dt =100 A / μs	-	4.5	-	μC

Note 1.Repeativity rating :pulse width limited by junction temperature

2.L=9.0mH I_{AS}=13A,V_{DD}=50V,R_G=0Ω,Starting T_J=25°C

3.I_{SD}≤13A,di/dt≤200A/us,V_{DD}<BV_{DSS},STARTING T_J=25°C

4.Pulse Test:Pulse Width≤300us,Duty Cycle≤2%

5. Essentially independent of operating temperature.

This transistor is an electrostatic sensitive device

Please handle with caution

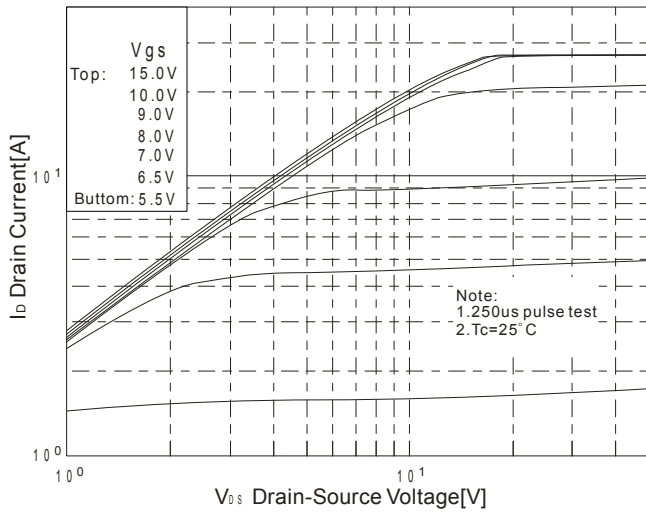

Fig.1 On Region Characteristics

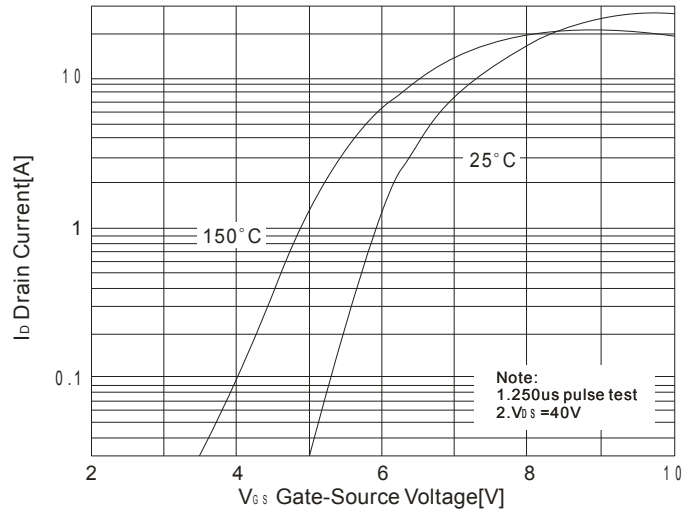

Fig.2 Transfer Characteristics

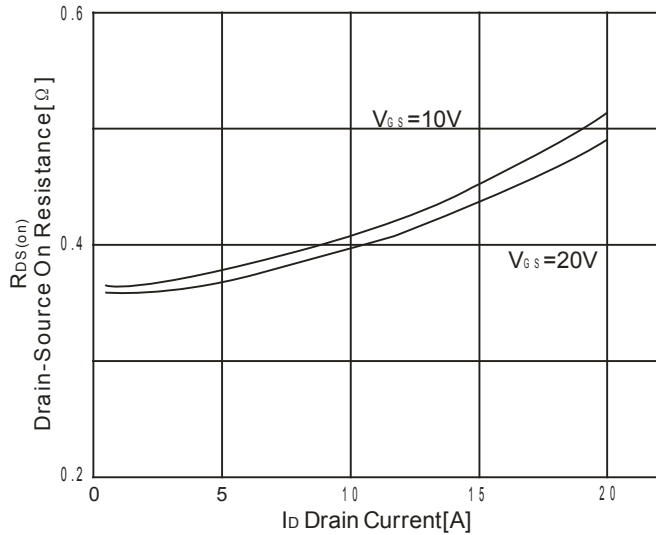

Fig.3 On-Resistance Variation vs Drain Current and Gate Voltage

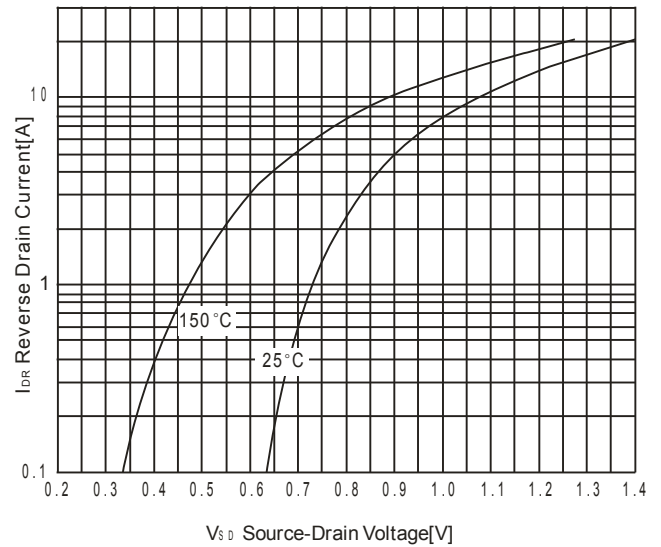

Fig.4 Body Diode Forward Voltage Variation vs. Source Current and Temperature

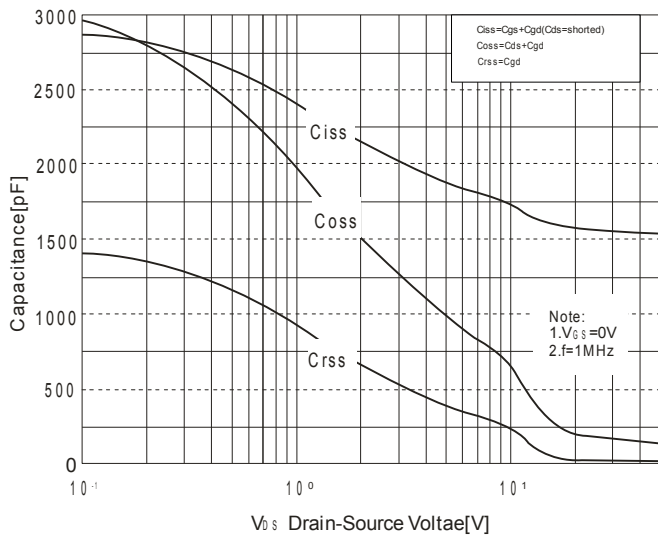

Fig.5 Capacitance Characteristics

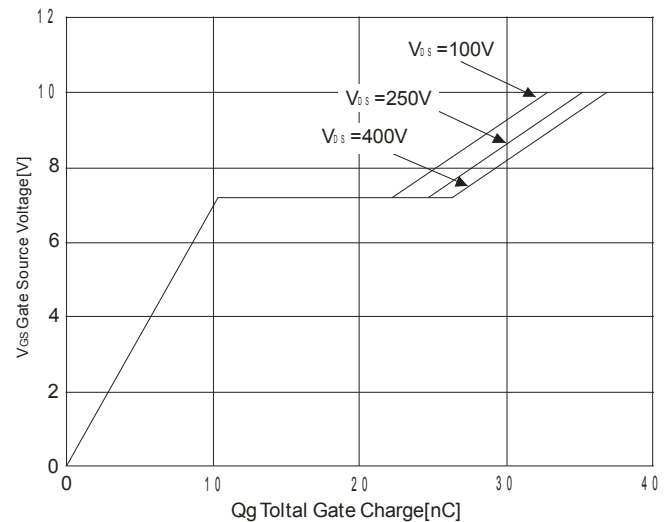

Fig.6 Gate Charge Characteristics

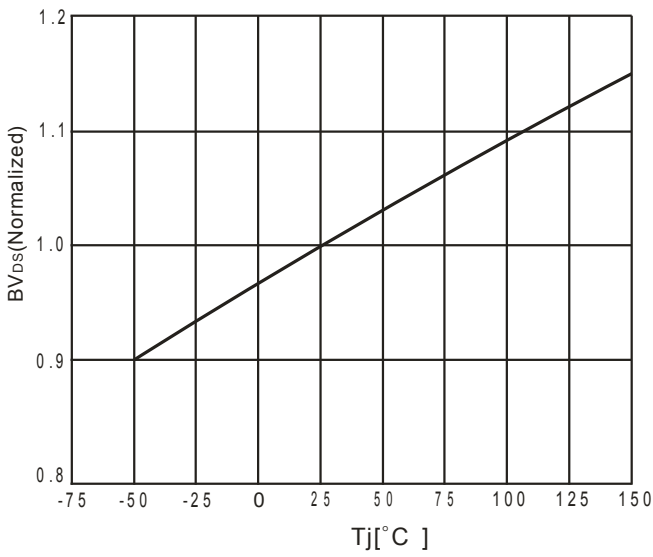

Fig.7 Breakdown Voltage Variation vs. Temperature

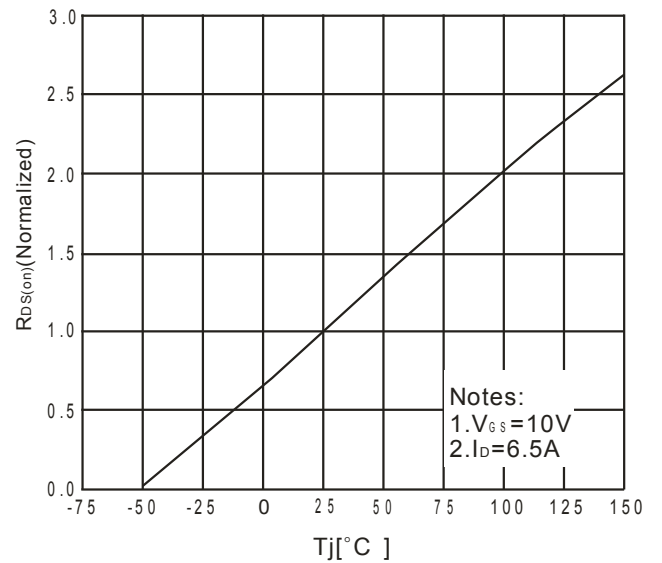

Fig.8 On-Resistance Variation vs. Temperature

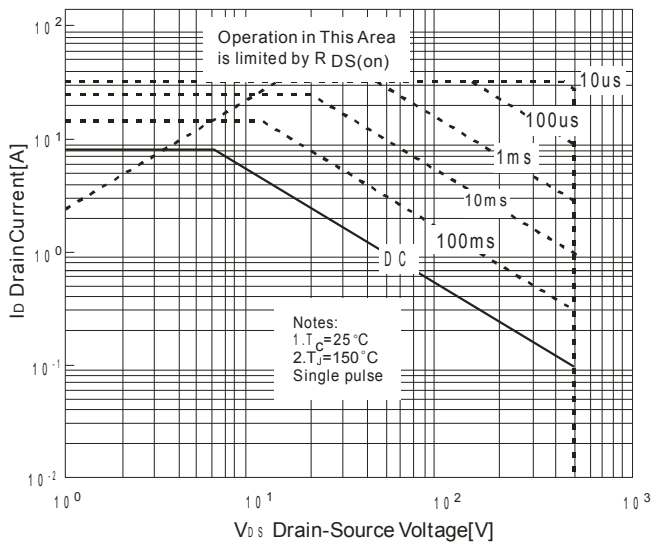

Fig.9 Maximum Safe Operation Area

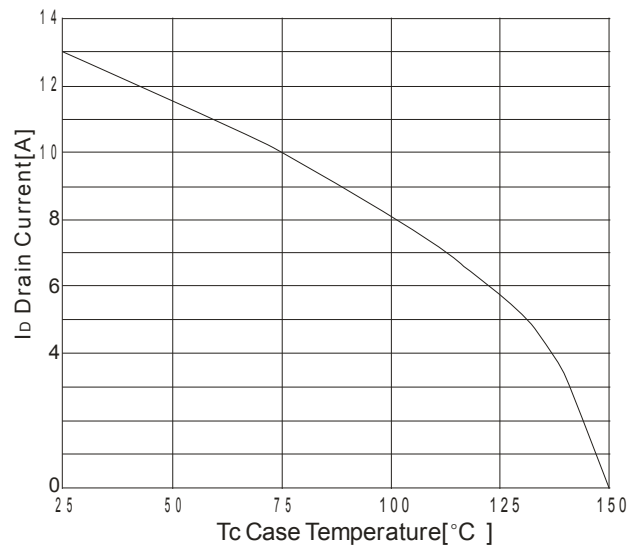

Fig.10 Maximum Drain Current vs Case temperature

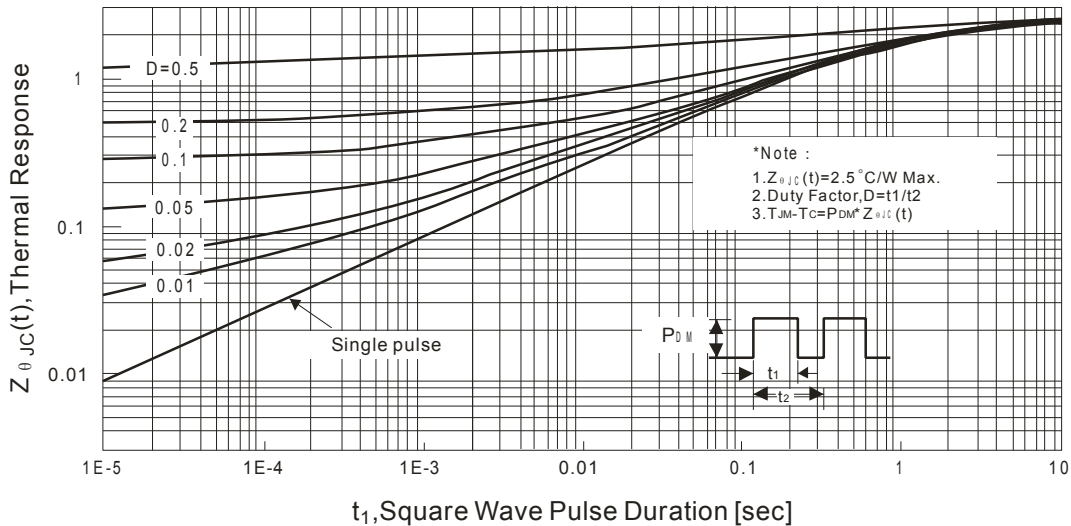

Fig.11 Transient thermal Response Curve

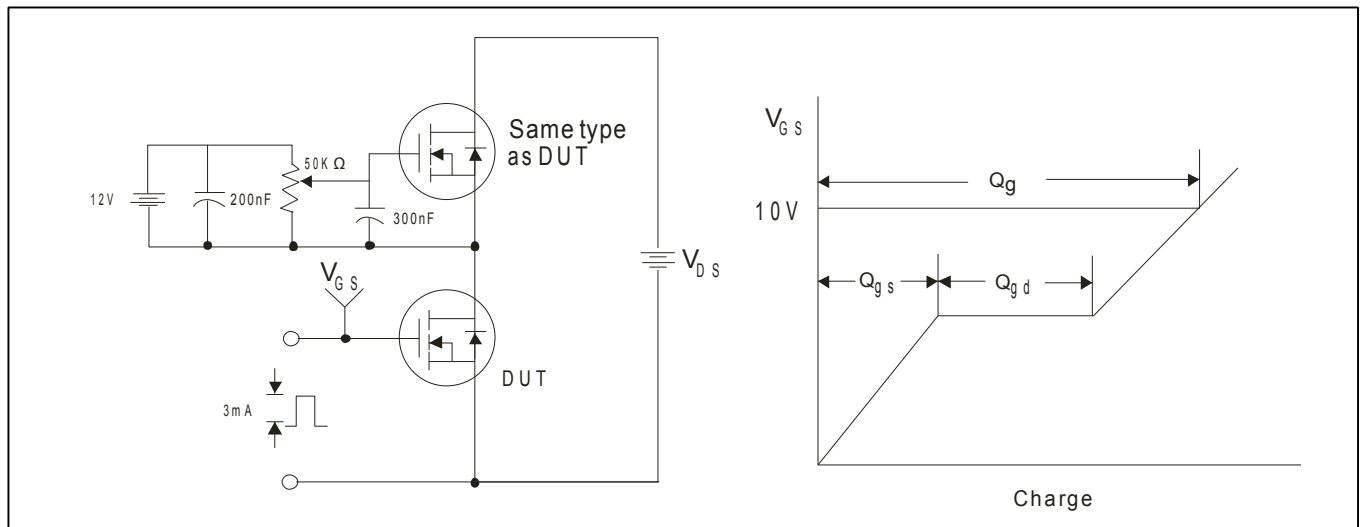

Fig.12 Gate Test circuit & Waveform

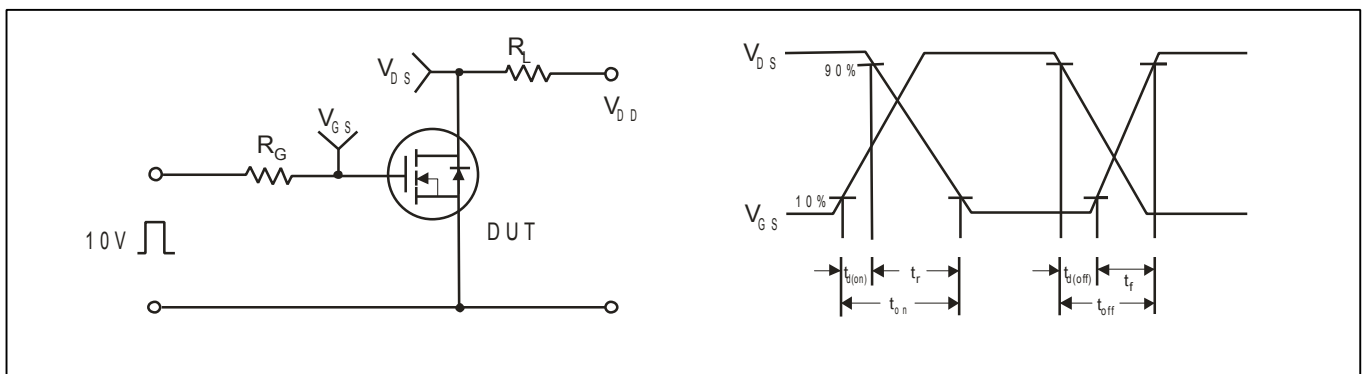

Fig.13 Resistive Switching Test Circuit & Waveform

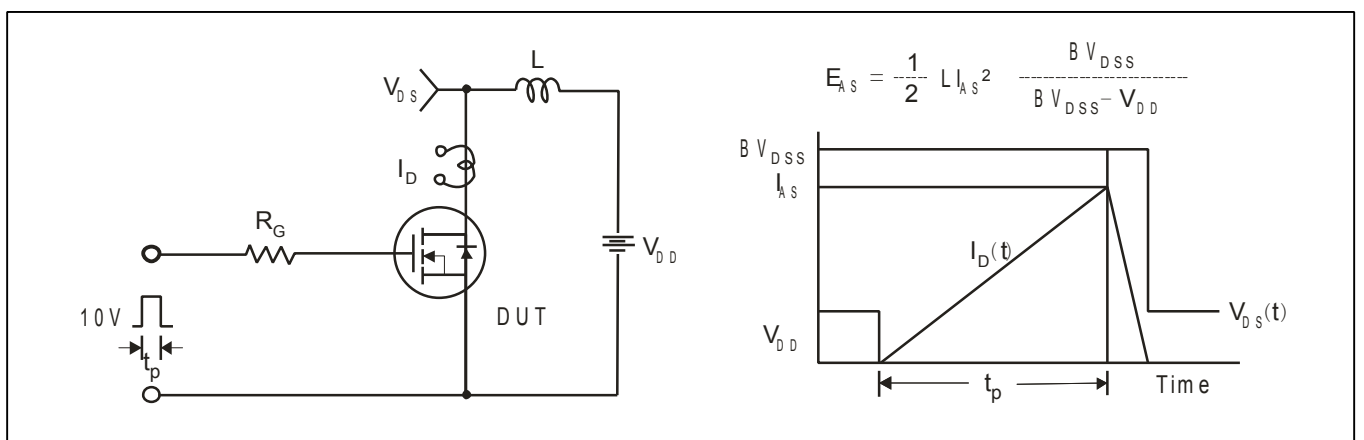

Fig.14 Unclamped Inductive Switching Test Circuit & Waveform

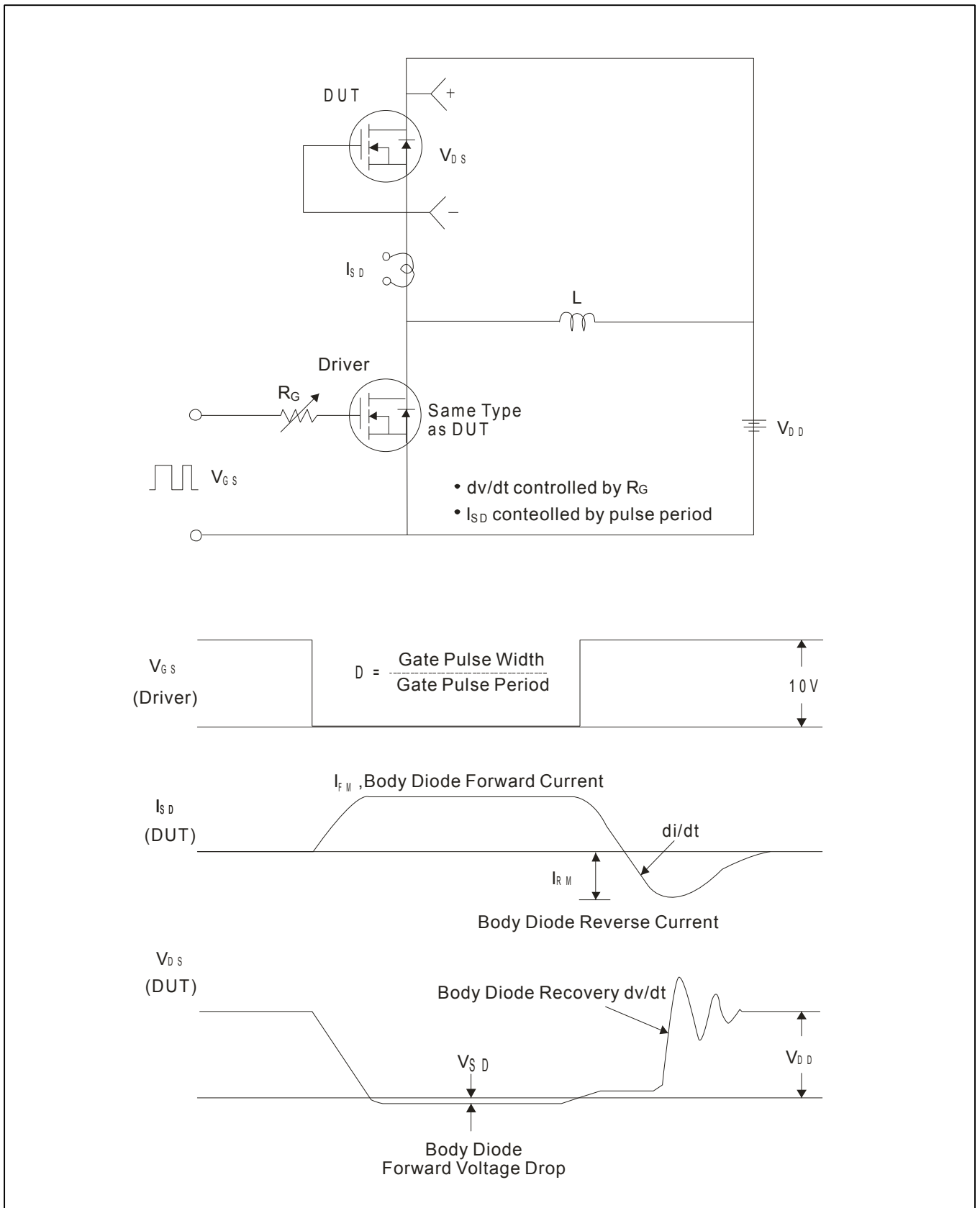
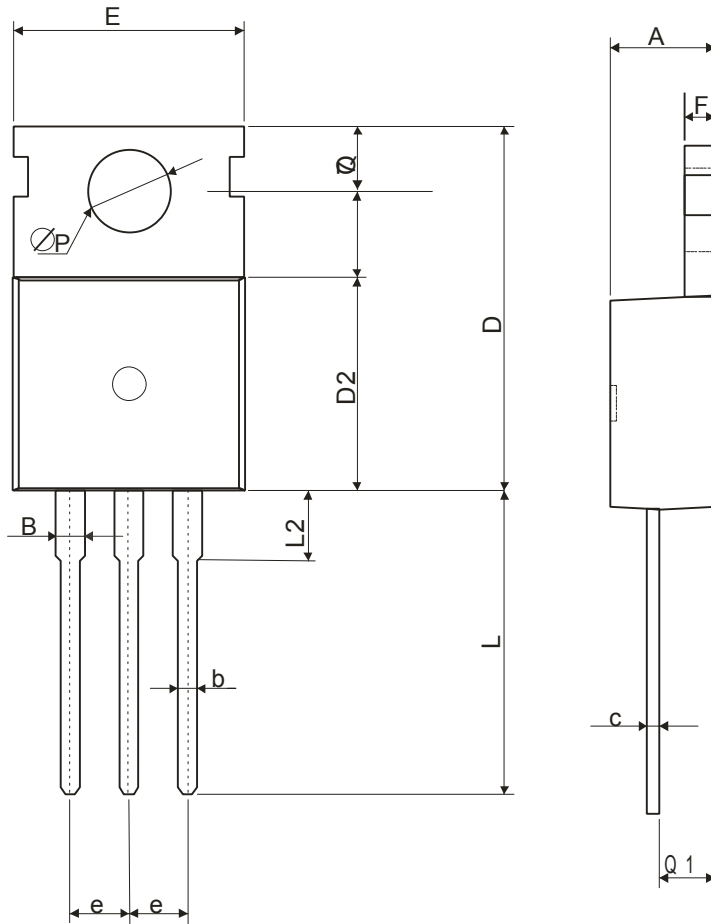

Fig.15 Peak Diode Recovery dv/dt Test Circuit & Waveform

TO-220C Package Dimension

Unit:mm



符号	MIN	MAX
A	4.30	4.70
B	1.10	1.40
b	0.70	0.95
c	0.40	0.65
d	15.2	16.2
D 2	9.00	9.40
E	9.70	10.10
e	2.39	2.69
F	1.25	1.40
L	12.60	13.60
L 2	2.80	3.20
Q	2.60	3.00
Q 1	2.20	2.60
P	3.50	3.80

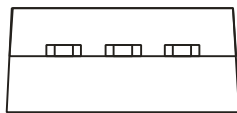

NOTE:

- 1.We strongly recommend customers check carefully on the trademark when buying our product, if there is any question, please don't be hesitate to contact us.
- 2.Please do not exceed the absolute maximum ratings of the device when circuit designing.
- 3.Winsemi Microelectronics Co., Ltd reserved the right to make changes in this specification sheet and is subject to change without prior notice.

CONTACT:

Winsemi Microelectronics Co., Ltd.

ADD:Futian District, ShenZhen Tian An Cyber Tech Plaza two East Wing 1002

Post Code : 518040

Tel : +86-755-8250 6288

FAX : +86-755-8250 6299

Web Site : www.winsemi.com