

RS4/RD4-R10

- 7 Pin SIL/ 14Pin DIL Package
- 1000VDC Isolation
- Up to 3000VDC Isolation
- Low Ripple and Noise
- Efficiency up to 73%
- Operating Temperature Range:
-40° ~ +85°C
- Non Conductive Black Plastic Case
- EMI Complies with EN55022 Class B



RoHS

OUTPUT SPECIFICATION	ENVIRONMENTAL SPECIFICATION
Voltage accuracy: ±2%	Operating Temperature range: -40°C ~+85°C (see Derating Curve)
Line regulation: ±0.5%	Maximum Case Temperature: 100°C
LOAD REGULATION: from 0% to 100% Load: ±0.5%	Storage Temperature : -40°C ~+125°C
Output 3.3V Model: ±1.0%	Cooling : Nature Convection
Ripple noise (20Mhz bandwidth): 50mV pk-pk	PHYSICAL SPECIFICATIONS:
Temperature coefficient: ±0.02% °C	Case Material: Non-conductive Black Plastic (UL94V-0 rated)
Capacitor load: See table	PIN Material: Ø 0.5mm Alloy42 Solder-coated
INPUT SPECIFICATIONS	Potting Material: Epoxy (UL94V-0 rated)
Voltage Range: ±10%	Weight Case- Sip: 2.7g
Max. Input Current: See table	Weight Case-DIP: 2.9g
No-Load/Full-Load Input Current: See table	Dimmension SIP: 0.76 x 0.28 x 0.39"
Input Filter: Capacitors	Dimmension DIP: 0.80 x 0.40 x 0.27"
Input Reflected Ripple Current : 20mA pk-pk	ABSOLUTE MAXIMUM RATINGS
GENERAL SPECIFICATIONS	Input Surge Voltage (100ms)/
Efficiency: See table	3,3V Models: 5VDC max
I/O Isolation Voltage (60sec): 1000 ~ 3000VDC	5 V Models: 7VDC max
I/O Isolation Capacitance: 60pF typ.	12V Models: 15VDC max
I/O Isolation Resistance: 1000M Ohm	24V Models: 28VDC max
Switching Frequency: Variable 50kHz	Soldering Temperature: 260°C max ⁽²⁾
Humidity: 95% rel H	EMC SPECIFICATIONS
Reliability Calculated MTBF : > 3.5Mhrs <small>(MIL-HDBK-217 f)</small>	Radiated-/Conducted Emissions: EN55022 Class B
Safety Standard: (designed to meet): IEC 60950-1	ESD: IEC 61000-4-2 Perf.Criteria A
	RS: IEC 61000-4-3 Perf.Criteria A
	EFT: IEC 61000-4-4 Perf.Criteria A
	SURGE: IEC 61000-4-5 Perf.Criteria A
	CS: IEC 61000-4-6 Perf.Criteria A
	PFMF IEC 61000-4-8 Perf.Criteria A

1) These are stress ratings. Exposure of devices to any of these conditions may adversely affect long-term reliability.

2) (1.5mm from case 10sec Max.)

3) All specifications typical at TA= 25°C, nominal input voltage and full load unless otherwise specified.

4) The information and specification contained in this data sheet are believed to be correct at time of publication. However RSG accepts no responsibility for consequences arising from printing errors or inaccuracies. Specifications are subject to change without notice.

NUMBER STRUCTURE

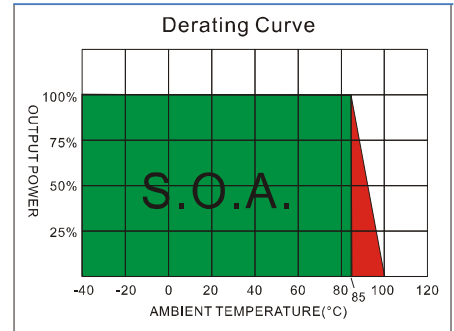
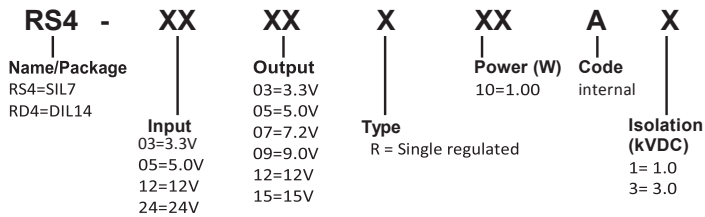

MODEL SELECTION GUIDE

MODEL NUMBER	INPUT	INPUT Current		OUTPUT	OUTPUT Current	EFFICIENCY @FL(%)	Capacitor Load(µF)
	Voltage Range (Vdc)	No-Load (mA)	Full Load (mA)	Voltage (Vdc)	Full load (mA)		
RS4-0503R10AX	5	30	385	3.3	333	57	220
RS4-0505 R10AX	5	30	307	5	200	65	220
RS4-0507 R10AX	5	30	307	7.2	138.9	65	220
RS4-0509 R10AX	5	35	307	9	111.1	65	220
RS4-0512 R10AX	5	35	294	12	83.3	68	220
RS4-0515 R10AX	5	35	294	15	66.7	68	220
RS4-1203 R10AX	12	20	160	3.3	333	57	220
RS4-1205 R10AX	12	20	132	5	200	63	220
RS4-1207 R10AX	12	20	128	7.2	138.9	65	220
RS4-1209 R10AX	12	20	126	9	111.1	66	220
RS4-1212 R10AX	12	20	122	12	83.3	68	220
RS4-1215 R10AX	12	20	126	15	66.7	66	220
RS4-2403 R10AX	24	10	76	3.3	333	60	220
RS4-2405 R10AX	24	10	64	5	200	65	220
RS4-2407 R10AX	24	10	64	7.2	138.9	65	220
RS4-2409 R10AX	24	10	61	9	111.1	68	220
RS4-2412 R10AX	24	10	61	12	83.3	68	220
RS4-2415 R10AX	24	10	61	15	66.7	68	220
RD4-0503 R10AX	5	30	350	3.3	333	57	220
RD4-0505 R10AX	5	35	317	5	200	63	220
RD4-0507 R10AX	5	45	327	7.2	138.9	61	220
RD4-0509 R10AX	5	40	298	9	111.1	67	220
RD4-0512 R10AX	5	35	298	12	83.3	67	220
RD4-0515 R10AX	5	35	298	15	66.7	67	220
RD4-1203 R10AX	12	20	146	3.3	333	57	220
RD4-1205 R10AX	12	20	132	5	200	63	220
RD4-1207 R10AX	12	20	132	7.2	138.9	63	220
RD4-1209 R10AX	12	20	128	9	111.1	65	220
RD4-1212 R10AX	12	20	122	12	83.3	68	220
RD4-1215 R10AX	12	20	126	15	66.7	66	220
RD4-2403 R10AX	24	10	73	3.3	333	57	220
RD4-2405 R10AX	24	10	76	5	200	60	220
RD4-2407 R10AX	24	10	76	7.2	138.9	60	220
RD4-2409 R10AX	24	10	61	9	111.1	68	220
RD4-2412 R10AX	24	10	63	12	83.3	66	220
RD4-2415 R10AX	24	10	63	15	66.7	66	220

Suffix "3" means 3 KVdc isolation

EMI Filter

Input filter components (C1, L) are used to help meet conducted emissions requirement for the module. These components should be mounted as close as possible to the module; and all leads should be minimized to decrease radiated noise.

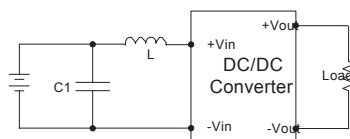

	C1	L
RS4-05XXR10AX	220uF/100V	12uH
RS4-12XX R10AX	220uF/100V	12uH
RS4-24XX R10AX	220uF/100V	12uH

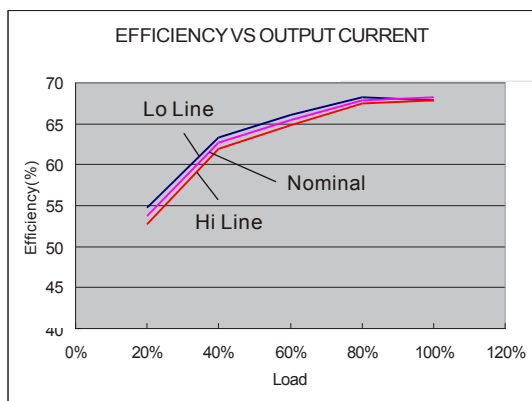

05 Models

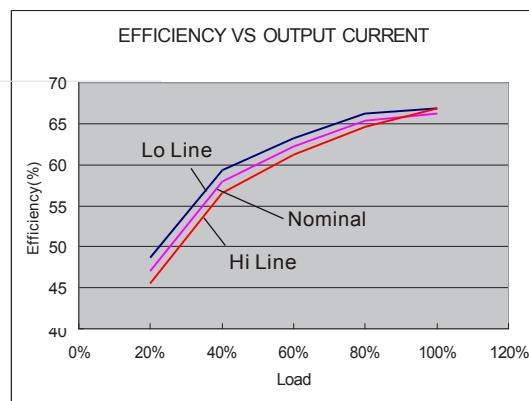

12 Models

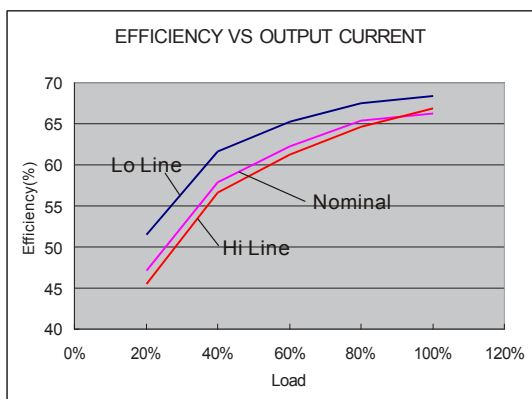

24 Models

RS4/RD4-R10

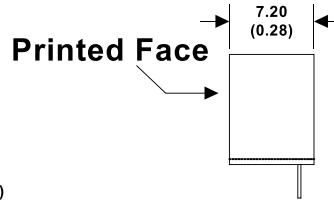
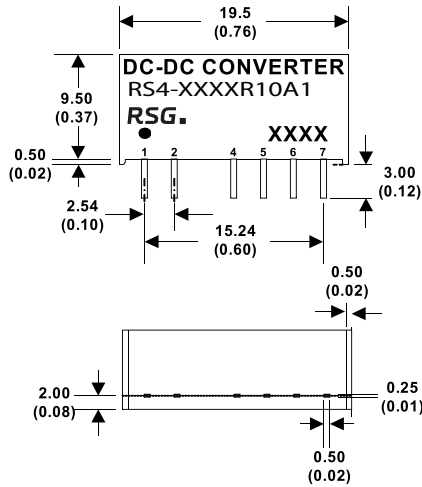

7 Pin SIL Package

- Notes : All dimensions are typical in millimeters (inches).
1. Pin diameter: 0.5 ± 0.05 (0.02 ± 0.002)
 2. Pin pitch and length tolerance: ± 0.35 (± 0.014)
 3. Case Tolerance: ± 0.5 (± 0.02)

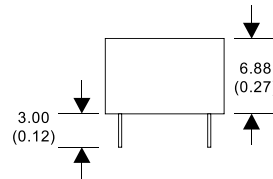
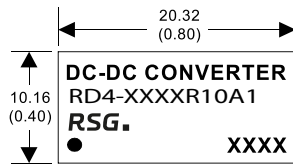

14 Pin DIL Package

- Notes : All dimensions are typical in millimeters (inches).
1. Pin diameter: 0.5 ± 0.05 (0.02 ± 0.002)
 2. Pin pitch and length tolerance: ± 0.35 (± 0.014)
 3. Case Tolerance: ± 0.5 (± 0.02)

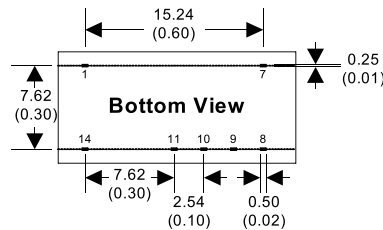

SIL 7

PIN CONNECTIONS		
PIN NUMBER	SINGLE	SINGLE-H
1	+V Input	+V Input
2	-V Input	-V Input
4	-V Output	N.P.
5	N.P.	-V Output
6	+V Output	N.P.
7	N.P.	+V Output

DIL 14

PIN CONNECTIONS		
PIN NUMBER	SINGLE	SINGLE-H
1	-V Input	-V Input
7	N.C.	N.C.
8	N.P.	+V Output
9	+V Output	N.P.
10	N.P.	-V Output
11	-V Output	N.P.
14	+V Input	+V Input

The models listed here are just standard type. If you need a product with special specification or you have questions regarding packing standards (Tube oder Tape/Reel) as well as application support, please contact our specialists: sales@rsg-electronic.de or +49 69-984047-41/-28