



**austriamicrosystems AG**

**is now**

**ams AG**

The technical content of this austriamicrosystems datasheet is still valid.

**Contact information:**

**Headquarters:**

ams AG

Tobelbaderstrasse 30

8141 Unterpremstaetten, Austria

Tel: +43 (0) 3136 500 0

e-Mail: [ams\\_sales@ams.com](mailto:ams_sales@ams.com)

Please visit our website at [www.ams.com](http://www.ams.com)

# AS1331

## 300mA Buck-Boost Synchronous DC/DC Converters

### 1 General Description

This special device is a synchronous buck-boost DC/DC converter which can handle input voltages above, below, or equal to the output voltage.

Due to the internal structure of the AS1331 which is working continuously through all operation modes this device is ideal for dual or triple cell alkaline/NiCad/NiMH as well as single cell Li-Ion battery applications.

Because of the implemented Power Save Mode, the solution footprint and the component count is minimized and also over a wide range of load currents a high conversion efficiency is provided.

The device includes two N-channel MOSFET switches and two P-channel switches. Also following features are implemented: a quiescent current of typically 22µA (ideal for battery power applications), a shutdown current less than 1µA, current limiting, thermal shutdown and output disconnect.

The AS1331 is available in a 10-pin 3x3mm TDFN package with fixed and adjustable output voltage.

### 2 Key Features

- Input Voltage Range: 1.8V to 5.5V
- Output Voltages:
  - Fixed: 2.5V, 3.0V, 3.3V
  - Adjustable: 2.5V to 3.3V
- Output Current: 300mA @ 3.3V
- Up to 90% efficiency
- Power Good
- Output Disconnection in Shutdown
- Automatic transition between Buck and Boost mode
- Ultra Low Quiescent Current: 22µA, Shutdown Current <1µA (Active Low)
- Short-Circuit Protection
- Low Battery detection
- Over Temperature Protection
- 10-pin 3x3mm TDFN package

### 3 Applications

The AS1331 is an ideal solution for handheld computers, handheld instruments, portable music players and PDA's. Two and three cell Alkaline, NiCd or NiMH or single cell Li battery powered products.

Figure 1. AS1331 - Typical Application Diagram

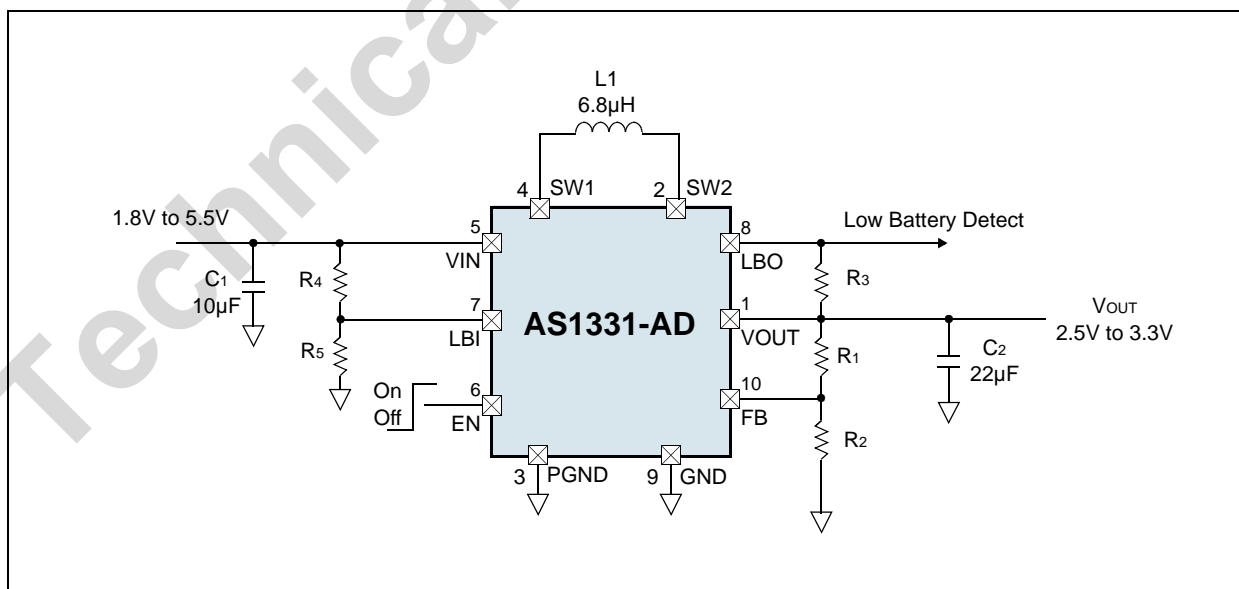

## 4 Pin Assignments

Figure 2. Pin Assignments (Top View)

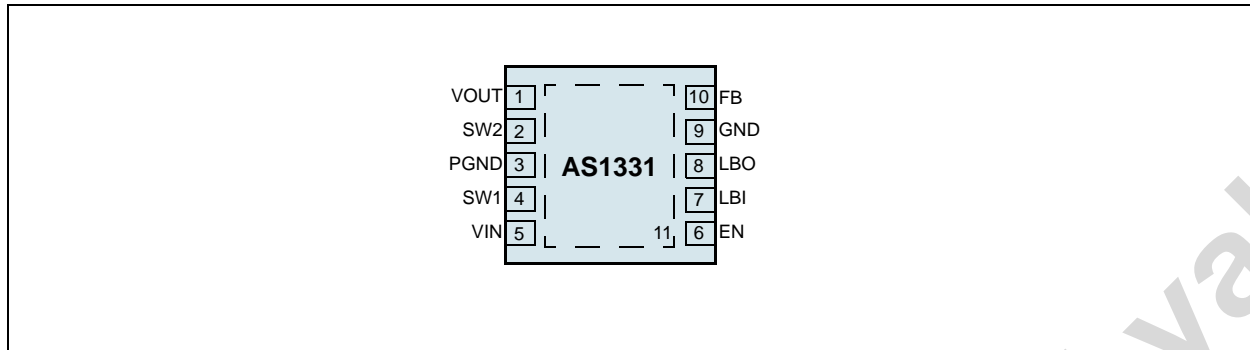

### Pin Descriptions

Table 1. Pin Descriptions

Pin Name	Pin Number	Description
VOUT	1	<b>Output of the Buck/Boost Converter.</b>
SW1	2	<b>Buck/Boost Switch Pin.</b> Connect the inductor from SW1 to SW2
PGND	3	<b>Power Ground.</b> Both GND pins must be connected.
SW2	4	<b>Buck/Boost Switch Pin.</b> Connect the inductor from SW1 to SW2. An optional Schottky diode can be connected between this pin and VOUT to increase efficiency.
VIN	5	<b>Input Supply Pin.</b> A minimum 2.2μF capacitor should be placed between VIN and GND.
EN	6	<b>Enable Pin.</b> Logic controlled shutdown input. 1 = Normal operation; 0 = Shutdown; quiescent current <1μA.
LBI	7	<b>Low Battery Comperator Input.</b> 1.25V Threshold. May not be left floating. If connected to GND LBO is working as Output Power okay.
LBO	8	<b>Low Battery Comperator Output.</b> This open-drain output is low when the voltage on LBI is less than 1.25V.
GND	9	<b>Ground.</b> Both GND pins must be connected.
FB	10	<b>Feedback Pin.</b> Feedback input for the adjustable version. Connect a resistor divider tap to this pin. The output voltage can be adjusted from 2.5V to 3.3V by: $V_{OUT} = 1.25V[1 + (R1/R2)]$ <b>Note:</b> For the fixed Output Voltage Version contact this pin to VOUT.
NC	11	<b>Exposed Pad.</b> This pad is not connected internally. It can be used for ground connection between GND and PGND.

## 5 Absolute Maximum Ratings

Stresses beyond those listed in [Table 2](#) may cause permanent damage to the device. These are stress ratings only, and functional operation of the device at these or any other conditions beyond those indicated in [Electrical Characteristics on page 4](#) is not implied. Exposure to absolute maximum rating conditions for extended periods may affect device reliability.

Table 2. Absolute Maximum Ratings

Parameter	Min	Max	Units	Notes
SW1, SW2, VIN, VOUT, EN	-0.3	+7	V	
PGND to GND	-0.3	+0.3	V	
SW1, SW2	-0.3	+7	V	
ESD	4		kV	HBM MIL-Std. 883E 3015.7 methods
Thermal Resistance $\theta_{JA}$	+33		°C/W	
Junction Temperature	+150		°C	
Operating Temperature Range	-40	85	°C	
Storage Temperature Range	-65	+125	°C	
Package Body Temperature	+260		°C	The reflow peak soldering temperature (body temperature) specified is in accordance with IPC/JEDEC J-STD-020D "Moisture/Reflow Sensitivity Classification for Non-Hermetic Solid State Surface Mount Devices". The lead finish for Pb-free leaded packages is matte tin (100% Sn).

## 6 Electrical Characteristics

$V_{IN} = 3.6V$ ,  $V_{OUT} = 3.3V$ ,  $T_{AMB} = -40^{\circ}C$  to  $+85^{\circ}C$ . Typical values are at  $T_{AMB} = +25^{\circ}C$ . Unless otherwise specified.

Table 3. Electrical Characteristics

Symbol	Parameter	Conditions	Min	Typ	Max	Units
<b>Input</b>						
$V_{IN}$	Input Voltage Range		1.8		5.5	V
	Minimum Startup Voltage	$I_{LOAD} < 1mA$		1.6	1.8	V
$V_{UV}$	Undervoltage Lockout Threshold <sup>1</sup>	$V_{IN}$ decreasing	1.5	1.6	1.7	V
<b>Regulation</b>						
$V_{OUT}$	Output Voltage Adjustable Version		2.50		3.30	V
	Output Voltage 3.3V	No Load	3.201	3.3	3.399	V
	Output Voltage 3.0V		2.910	3.0	3.090	V
	Output Voltage 2.5V		2.425	2.5	2.575	V
$V_{FB}$	FB Voltage Adjustable version	No Load	1.212	1.25	1.288	V
$I_{FB}$	FB Input Current Adjustable Version	$V_{FB} = 1.3V$ , $T_{AMB} = 25^{\circ}C$		1	100	nA
	$V_{OUT}$ Lockout Threshold <sup>2</sup>	Rising Edge	2.0	2.15	2.3	V
<b>Operating Current</b>						
$I_Q$	Quiescent Current $V_{IN}$	$V_{IN} = 5V$		2	6	$\mu A$
	Quiescent Current $V_{OUT}$	$V_{IN} = 5V$ , $V_{OUT} = 3.6V$ , $V_{FB} = 1.3V$		20	32	$\mu A$
$I_{SHDN}$	Shutdown Current	$EN = 0V$ , $V_{OUT} = 0V$ , $T_{AMB} = +25^{\circ}C$		0.01	1	$\mu A$
<b>Switches</b>						
$I_{MOS}$	MOS Switch Leakage	$V_{IN} = 5V$ , $T_{AMB} = 25^{\circ}C$ , Switches A-D		0.01	1	$\mu A$
$R_{ON}$	NMOS B, C	$V_{IN} = 5V$		0.13		$\Omega$
	PMOS A	$V_{IN} = 5V$		0.17		$\Omega$
	PMOS D	$V_{OUT} = 3.3V$		0.21		$\Omega$
$I_{PEAK}$	Peak Current Limit	$L = 6.8\mu H$ , $V_{IN} = 5V$	450	600	750	mA
<b>Enable</b>						
$V_{ENH}$	EN Input High		1.4			V
$V_{ENL}$	EN Input Low				0.4	V
$I_{EN}$	EN Input Current	$EN = 5.5V$ , $T_{AMB} = 25^{\circ}C$		1	100	nA
<b>Low Battery &amp; Power-OK</b>						
$V_{LBI}$	LBI Threshold	Falling Edge	1.212	1.25	1.288	V
	LBI Hysteresis			10		mV
	LBI Leakage Current	$LBI = 5.5V$ , $T_{AMB} = 25^{\circ}C$		1	100	nA
	LBO Voltage Low <sup>3</sup>	$I_{LBO} = 1mA$		0.05	0.2	V
	LBO Leakage Current	$LBO = 5.5V$ , $T_{AMB} = 25^{\circ}C$		1	100	nA
	Power-OK Threshold	$LBI = 0V$ , Falling Edge	90	92.5	95	%

Table 3. Electrical Characteristics

Symbol	Parameter	Conditions	Min	Typ	Max	Units
<b>Thermal Protection</b>						
	Thermal Shutdown	10°C Hysteresis		145		°C

1. If the input voltage falls below this value during normal operation the device goes in startup mode.
2. The regulator is in startup mode until this voltage is reached. Caution: Do not apply full load current until the device output > 2.3V
3. LBO goes low in startup mode as well as during normal operation if:
  - 1) The voltage at the LBI pin is below LBI threshold.
  - 2) The voltage at the LBI pin is below 0.1V and V<sub>OUT</sub> is below 92.5% of its nominal value.

**Note:** All limits are guaranteed. The parameters with min and max values are guaranteed with production tests or SQC (Statistical Quality Control) methods.

## 7 Typical Operating Characteristics

Circuit of [Figure 24](#) on page 12,  $V_{IN} = 2.4V$ ,  $V_{OUT} = 3.3V$ ,  $T_{AMB} = +25^{\circ}C$ , unless otherwise specified.

Figure 3. Efficiency vs. Output Current;  $V_{OUT} = 2.5V$

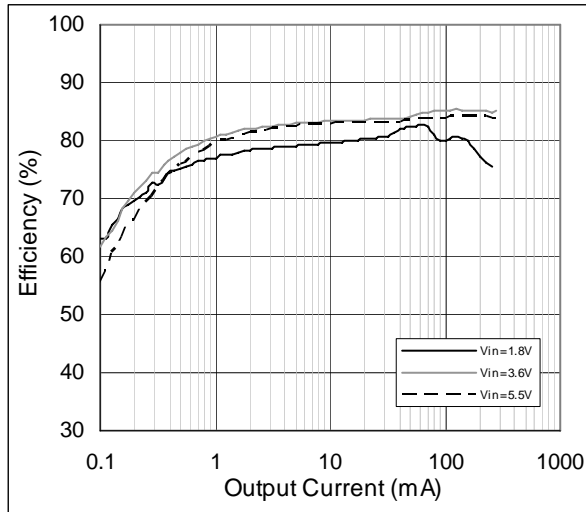

Figure 4. Efficiency vs. Output Current;  $V_{OUT} = 3.0V$

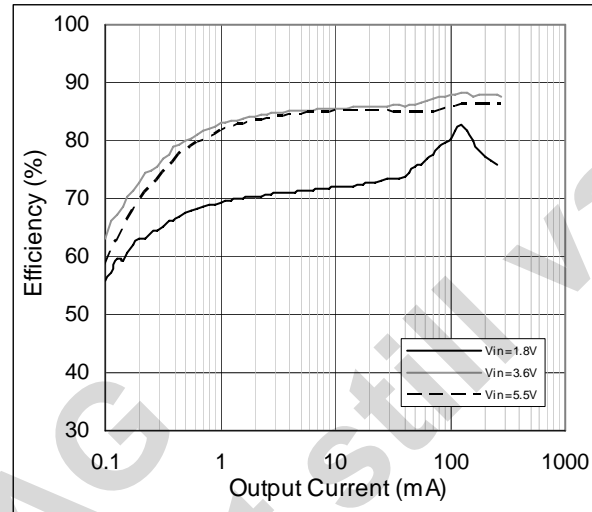

Figure 5. Efficiency vs. Output Current;  $V_{OUT} = 3.3V$

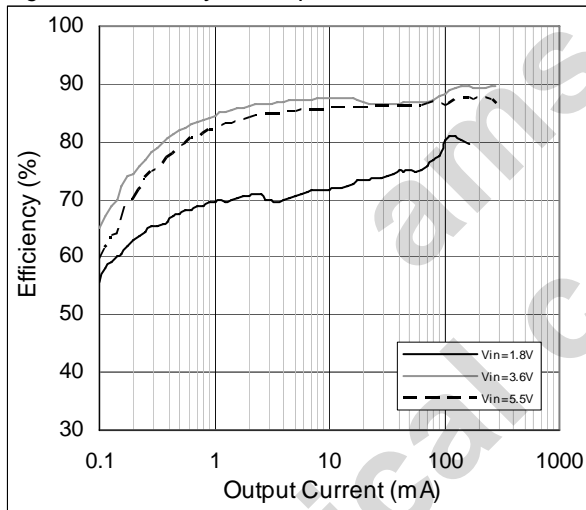

Figure 6. Efficiency vs. Input Voltage

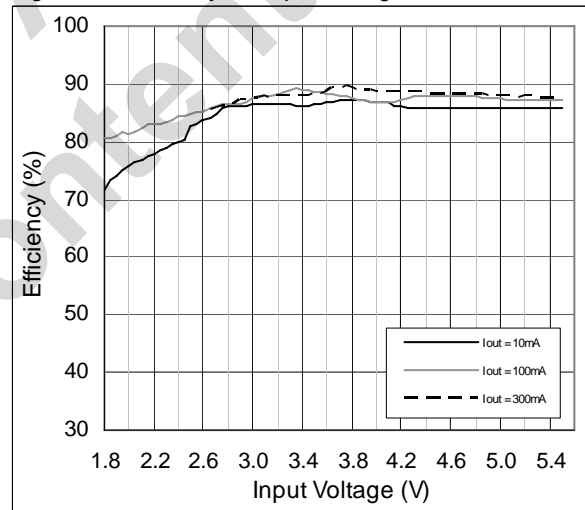

Figure 7.  $I_{OUT\ max}$  vs. Input Voltage

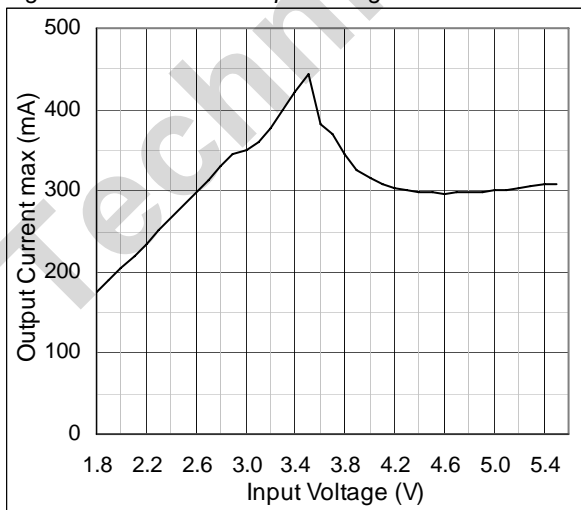

Figure 8. Sleep Currents vs. Input Voltage

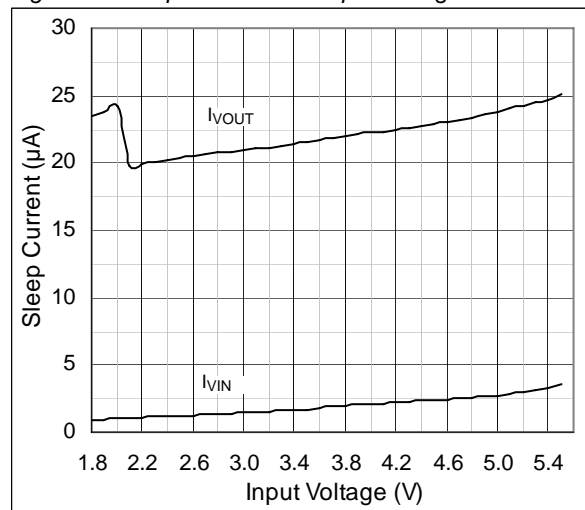

Figure 9.  $I_{IN}$  Short Circuit vs. Input Voltage

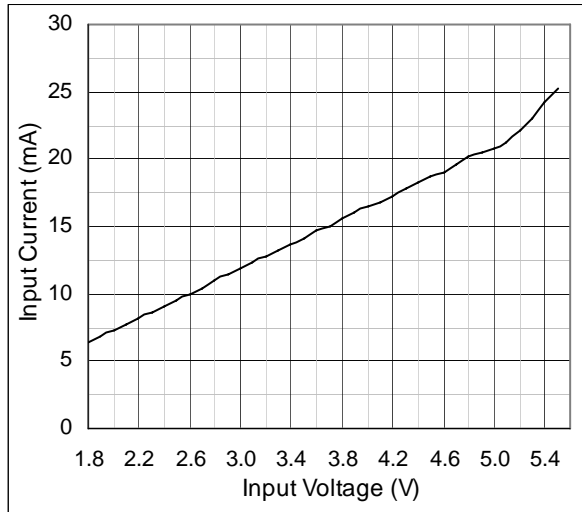

Figure 10.  $V_{OUT}$  Ripple vs. Input Voltage

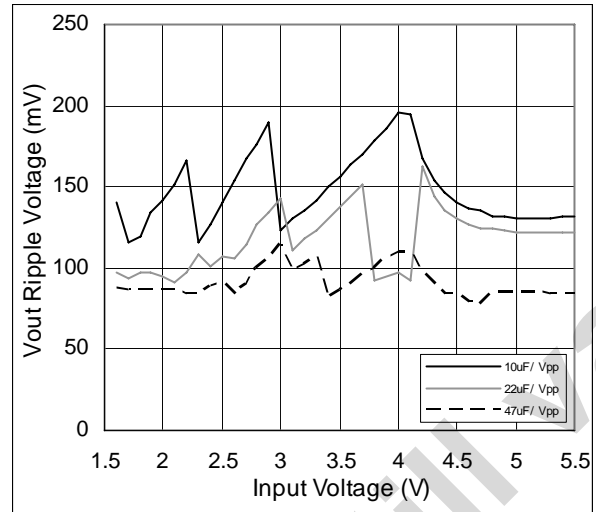

Figure 11. Load Regulation vs. Load Current

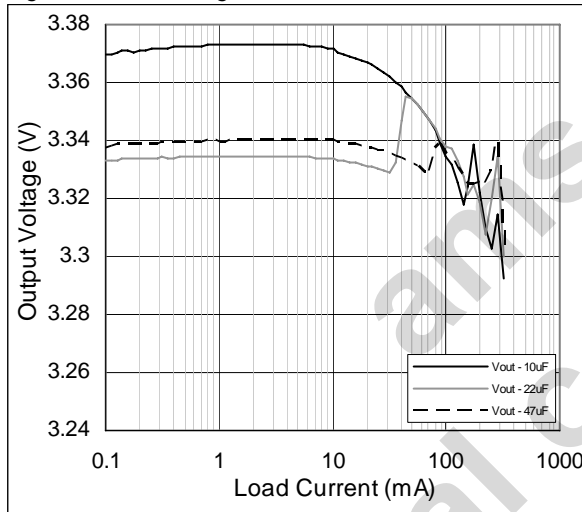

Figure 12.  $V_{OUT}$  Regulation vs. Temperature

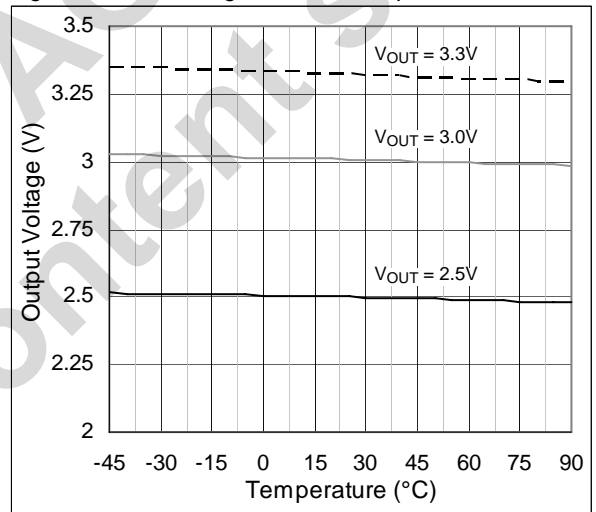

Figure 13.  $I_{FB}$  vs. Temperature;  $V_{IN} = 5V$

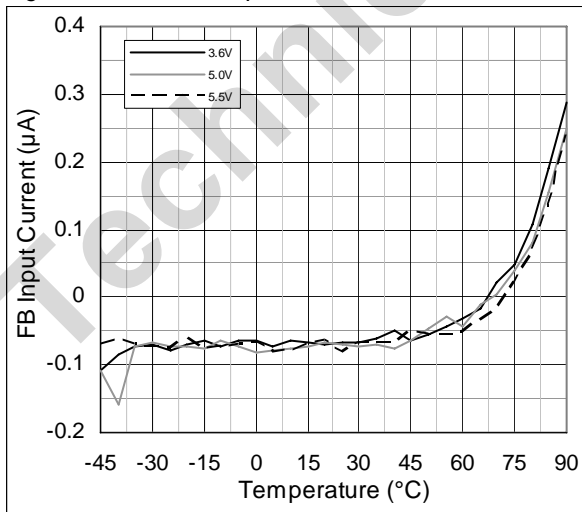

Figure 14. EN Pin Threshold

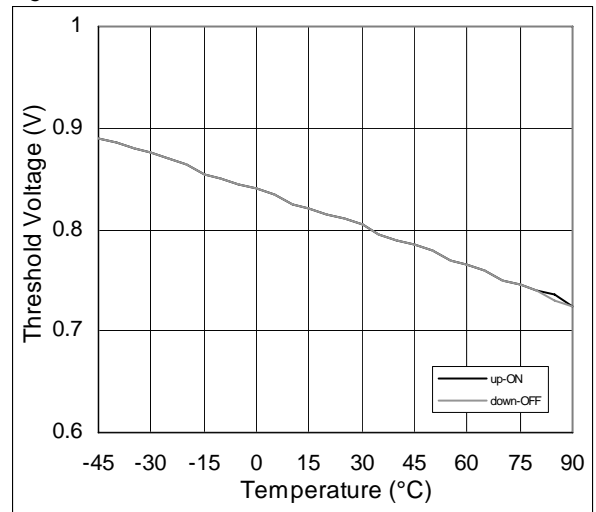



Figure 15.  $V_{IN} = 4.4V$ ,  $V_{OUT} = 3.3V$ ,  $I_{OUT} = 200mA$

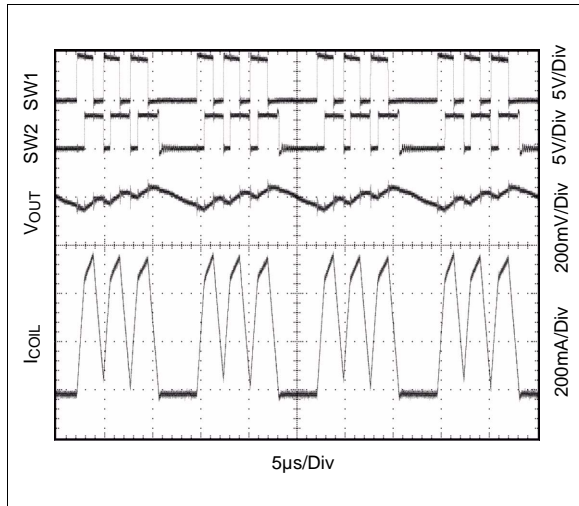

Figure 16.  $V_{IN} = 4.4V$ ,  $V_{OUT} = 3.3V$ ,  $I_{OUT} = 50mA$

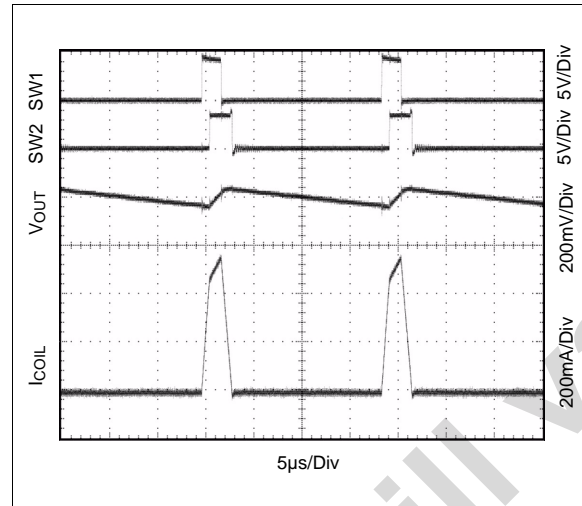

Figure 17.  $V_{IN} = 3.6V$ ,  $V_{OUT} = 3.3V$ ,  $I_{OUT} = 200mA$

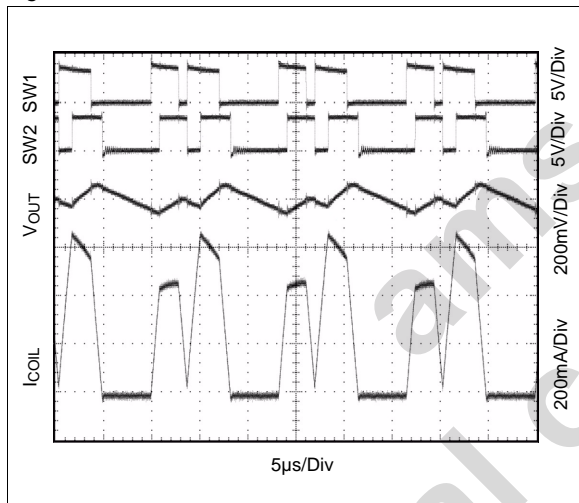

Figure 18.  $V_{IN} = 3.6V$ ,  $V_{OUT} = 3.3V$ ,  $I_{OUT} = 50mA$

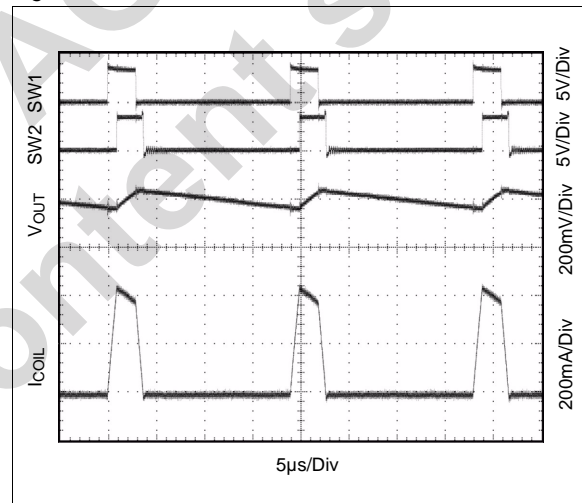

Figure 19.  $V_{IN} = 2.5V$ ,  $V_{OUT} = 3.3V$ ,  $I_{OUT} = 200mA$

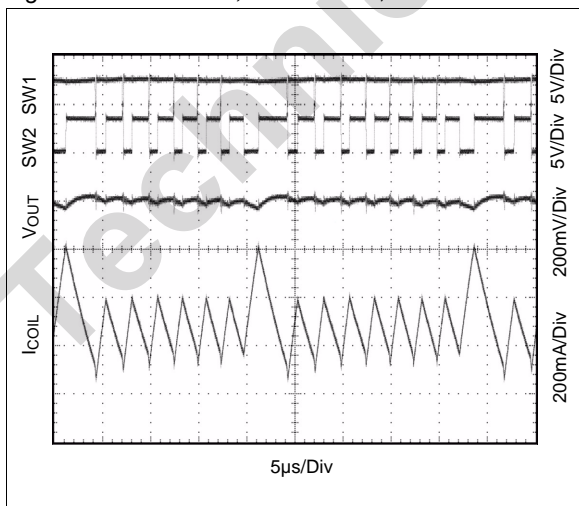

Figure 20.  $V_{IN} = 2.5V$ ,  $V_{OUT} = 3.3V$ ,  $I_{OUT} = 50mA$

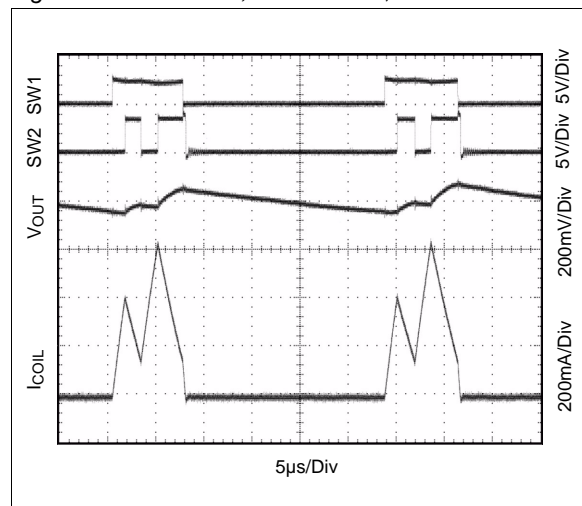

Figure 21. Shorted Output;  $V_{IN} = 3.6V$

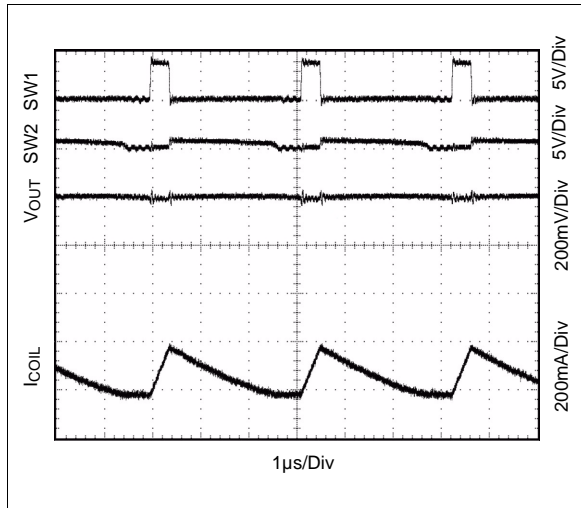
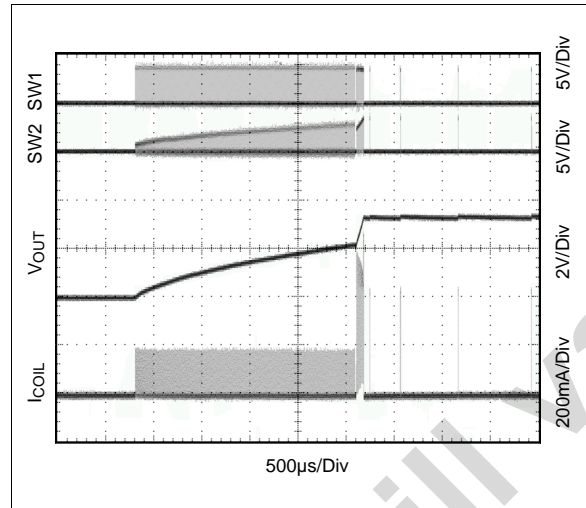

Figure 22. Startup;  $V_{IN} = 3.6V, R_{load} = 3.3k\Omega$



ams AG  
Technical content still valid

## 8 Detailed Description

The synchronous buck-boost converter AS1331 uses a Power Save Mode control technique to reach a high efficiency over a wide dynamic range of load currents. The output voltage is monitored by a comparator with 3% accuracy. The Power Save Mode puts the device into "sleep mode" when  $V_{OUT}$  is above its programmed reference threshold. Meaning, the switching is stopped and only quiescent current is drawn from the power source. The switching is started again when  $V_{OUT}$  drops below the reference threshold and the output capacitor is charged again.

The numbers of current pulses which are necessary to load the output capacitor are set by the value of the output capacitor, the load current, and the comparator hysteresis (~1%).

Figure 23. AS1331 - Block Diagram - Fixed Output Voltage

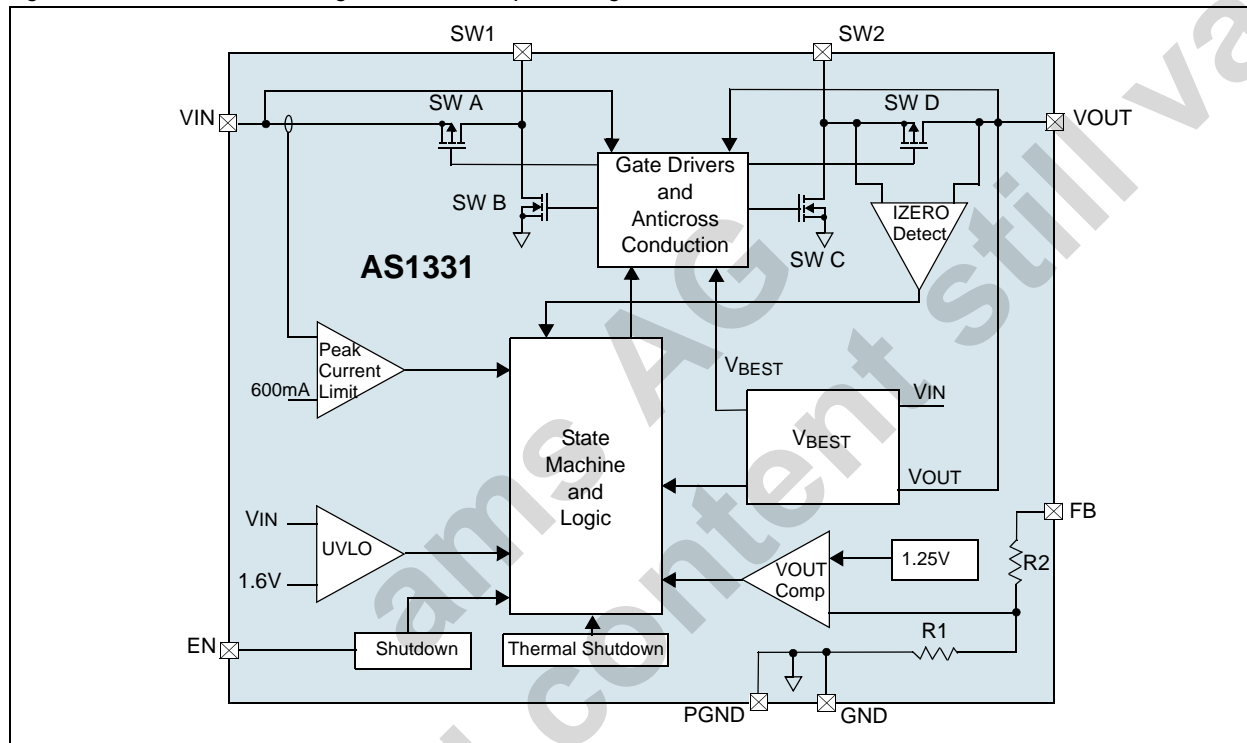

### Modes of Operation

When  $V_{OUT}$  drops below the reference threshold, the AS1331 switches on the transistors SW A and SW C until the inductor current reaches approximately 400mA. In the next step SW A and SW D are closed and depending on the difference between  $V_{IN}$  and  $V_{OUT}$  the inductor current raises, falls or stays constant.

$V_{IN} > V_{OUT}$ : The inductor current is going up to 600mA.

$V_{IN} \sim V_{OUT}$ : The device stops after 2 $\mu$ s.

$V_{IN} < V_{OUT}$ : The inductor current falls down to 0mA.

If the inductor current is not 0mA, the transistors SW B and SW D are closed to ramp down the current to zero. If  $V_{OUT}$  is still below the threshold voltage the next cycle is started. If  $I_{MAX}$  (600mA) wasn't reached in the previous cycle, SW A and SW D are closed until the inductor current is 600mA.

**Note:** The 4-switch-mode (SW A+SW C => SW B+SW D => SW A + SW C...) and also the buck-mode (SW A+SW D => SW B+SW D => SW A+SW D...) are never used.

### Start-Up Mode

At start-up the switch SW D is disabled and its diode is used to transfer current to the output capacitor until  $V_{OUT}$  reaches approximately 2.15V. The inductor current is controlled by an alternate algorithm during start-up.

**Note:** Do not apply loads >1mA until  $V_{OUT} = 2.3V$  is reached.

## Other AS1331 Features

### Shutdown

The part is in shutdown mode while the voltage at pin EN is below 0.4V and is active when the voltage is higher than 1.4V.

**Note:** EN can be driven above  $V_{IN}$  or  $V_{OUT}$ , as long as it is limited to less than 5.5V.

### Output Disconnect and Inrush Limiting

During shutdown  $V_{OUT}$  is going to 0V so that no current from the input source is running thru the device. The inrush current is also limited at turn-on mode to minimize the surge currents seen by the input supply. These features of the AS1331 are realized by opening both P-channel MOSFETs of the rectifiers, allowing a true output disconnect.

### Power-OK and Low-Battery-Detect Functionality

LBO goes low in startup mode as well as during normal operation if:

- The voltage at the LBI pin is below LBI threshold (1.25V). This can be used to monitor the battery voltage.
- LBI pin is connected to GND and  $V_{OUT}$  is below 92.5% of its nominal value. LBO works as a power-OK signal in this case.

The LBI pin can be connected to a resistive-divider to monitor a particular definable voltage and compare it with a 1.25V internal reference. If LBI is connected to GND an internal resistive-divider is activated and connected to the output. Therefore, the Power-OK functionality can be realised with no additional external components.

The Power-OK feature is not active during shutdown and provides a power-on-reset function that can operate down to  $V_{IN} = 1.8V$ . A capacitor to GND may be added to generate a power-on-reset delay. To obtain a logic-level output, connect a pull-up resistor from pin LBO to pin  $V_{OUT}$ . Larger values for this resistor will help to minimize current consumption; a 100k $\Omega$  resistor is perfect for most applications (see Figure 25 on page 12).

For the circuit shown in the left of Figure 24 on page 12, the input bias current into LBI is very low, permitting large-value resistor-divider networks while maintaining accuracy. Place the resistor-divider network as close to the device as possible. Use a defined resistor for  $R_5$  and then calculate  $R_4$  as:

$$R_4 = R_5 \cdot \left( \frac{V_{IN}}{V_{LBI}} - 1 \right) \quad (EQ 1)$$

#### Where:

$V_{LBI}$  (the internal sense reference voltage) is 1.25V.

In case of the LBI pin is connected to GND, an internal resistor-devider network is activated and compares the output voltage with a 92.5% voltage threshold. For this particular Power-OK application, no external resistive components are necessary.

### Thermal Shutdown

To prevent the AS1331 from short-term misuse and overload conditions the chip includes a thermal overload protection. To block the normal operation mode all switches will be turned off. The device is in thermal shutdown when the junction temperature exceeds 145°C. To resume the normal operation the temperature has to drop below 135°C.

A good thermal path has to be provided to dissipate the heat generated within the package. Otherwise it's not possible to operate the AS1331 at its useable maximal power. To dissipate as much heat as possible away from the package into a copper plane with as much area as possible, it's recommended to use multiple vias in the printed circuit board. It's also recommended to solder the Exposed Pad (pin 11) to the GND plane.

**Note:** Continuing operation in thermal overload conditions may damage the device and is considered bad practice.

## Output Voltage Selection

The AS1331 is available in two versions (see [Ordering Information on page 15](#)). One version can only operate at one fixed output voltage (see [Figure 25](#)) and the other version can operate with user-adjustable output voltages from 2.5V to 3.3V by connecting a voltage divider between the pins VOUT and FB (see [Figure 24](#)).

Figure 24. Lilon to Adjustable Output Voltage

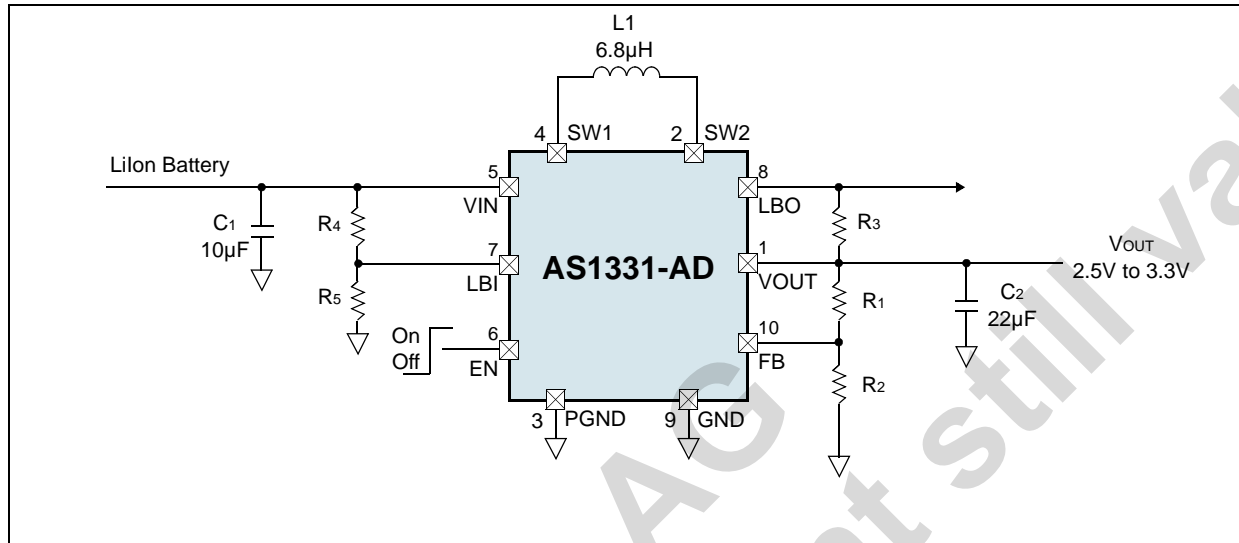

The output voltage can be adjusted by selecting different values for R1 and R2.

Calculate VOUT by:

$$V_{OUT} = V_{FB} \times \left(1 + \frac{R_1}{R_2}\right) \quad (\text{EQ 2})$$

### Where:

$V_{FB} = 1.25\text{V}$ ,  $V_{OUT} = 2.5\text{V to } 3.3\text{V}$ ;

R2 (the predefined resistor in the resistor divider) should be  $\leq 270\text{k}\Omega$ .

R3 (the Pull-up resistor for the LBO pin) should be  $\sim 100\text{k}\Omega$ .

Figure 25. Lilon to 3.3V with POK - Fixed Output Voltage

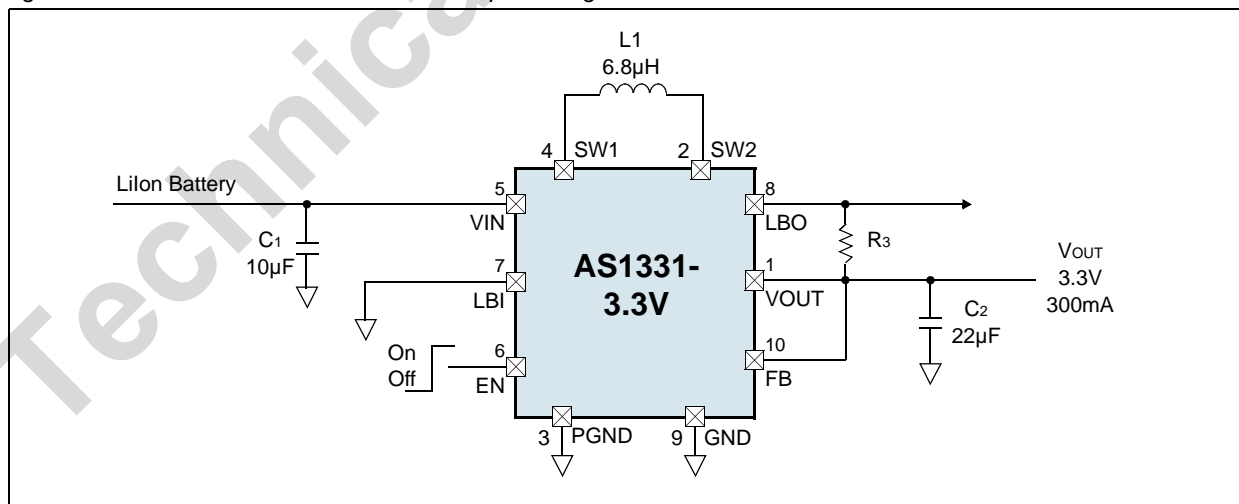

## 9 Application Information

### Component Selection

Only three power components are required to complete the design of the buck-boost converter. For the adjustable version  $V_{OUT}$  programming resistors are needed. The high operating frequency and low peak currents of the AS1331 allow the use of low value, low profile inductors and tiny external ceramic capacitors.

### Inductor Selection

For best efficiency, choose an inductor with high frequency core material, such as ferrite, to reduce core losses. The inductor should have low DCR (DC resistance) to reduce the  $I^2R$  losses, and must be able to handle the peak inductor current without saturating. A 6.8 $\mu$ H inductor with a >600mA current rating and <400m $\Omega$  DCR is recommended.

Table 4. Recommended Inductors

Part Number	L	DCR	Current Rating	Dimensions (L/W/T)	Manufacturer
LPS3015-682M	6.8 $\mu$ H	300m $\Omega$	0.89A	3.0x3.0x1.5mm	Coilcraft <a href="http://www.coilcraft.com">www.coilcraft.com</a>
EPL2014-682M	6.8 $\mu$ H	287m $\Omega$	0.80A	2.0x2.0x1.4mm	
XPL2010-682M	6.8 $\mu$ H	336m $\Omega$	0.73A	2.0x1.9x1.0mm	

### Capacitor Selection

The buck-boost convertor requires two capacitors. Ceramic X5R or X7R types will minimize ESL and ESR while maintaining capacitance at rated voltage over temperature. The  $V_{IN}$  capacitor should be at least 2.2 $\mu$ F. The  $V_{OUT}$  capacitor should be between 10 $\mu$ F and 47 $\mu$ F. A larger output capacitor should be used if lower peak to peak output voltage ripple is desired. A larger output capacitor will also improve load regulation on  $V_{OUT}$ . See Table 5 for a list of capacitors for input and output capacitor selection.

Table 5. Recommended Input Capacitor

Part Number	C	TC Code	Rated Voltage	Dimensions (L/W/T)	Manufacturer
GRM188R61A225KE34	2.2 $\mu$ F	X5R	10V	0603, T=0.87mm	Murata <a href="http://www.murata.com">www.murata.com</a>
GRM188R60J475KE19	4.7 $\mu$ F	X5R	6.3V	0603, T=0.87mm	
GRM219R60J106KE19	10 $\mu$ F	X5R	6.3V	0805, T=0.95mm	

Table 6. Recommended Output Capacitor

Part Number	C	TC Code	Rated Voltage	Dimensions (L/W/T)	Manufacturer
GRM21BR61A106KE19	10 $\mu$ F	X5R	10V	0805, T=1.35mm	Murata <a href="http://www.murata.com">www.murata.com</a>
GRM319R61A106KE19	10 $\mu$ F	X5R	10V	1206, T=0.95mm	
GRM319R61A106KE19	10 $\mu$ F	X5R	10V	1210, T=0.95mm	
GRM31CR61C226KE15	22 $\mu$ F	X5R	16V	1206, T=1.8mm	
GRM31CR60J475ME19	47 $\mu$ F	X5R	6.3V	1206, T=1.75mm	

## 10 Package Drawings and Markings

The device is available in a 10-pin 3x3mm TDFN package.

Figure 26. 10-pin 3x3mm TDFN package Diagram

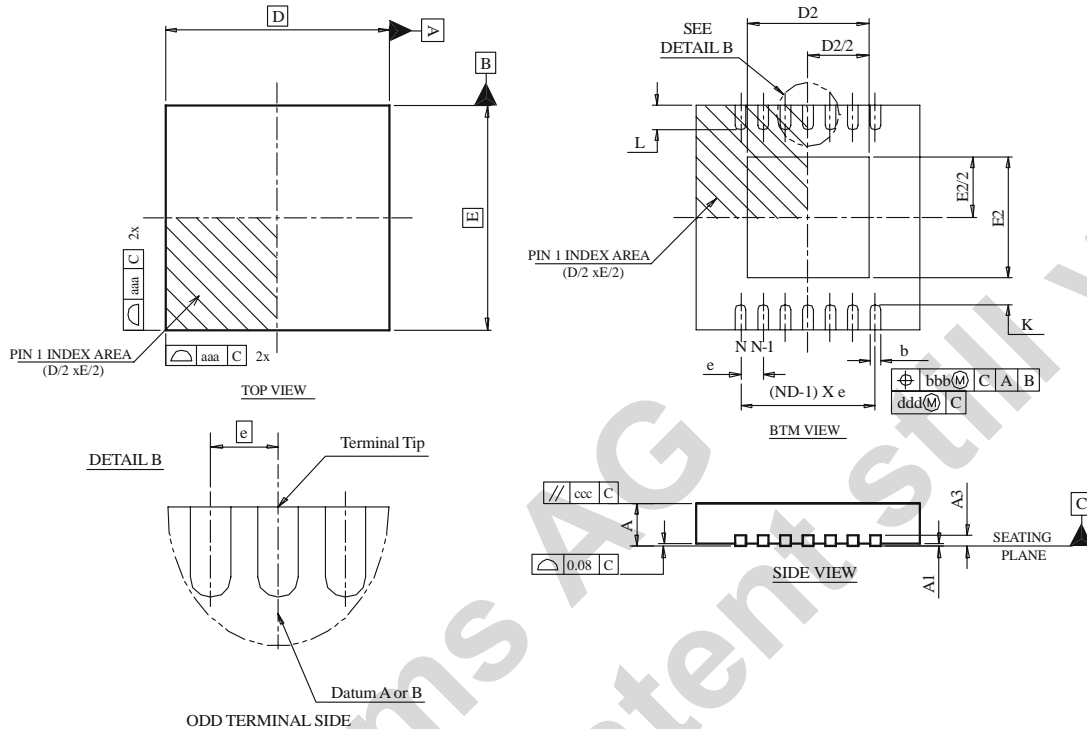

Table 7. 10-pin 3x3mm TDFN package Dimensions

Symbol	Min	Typ	Max	Symbol	Min	Typ	Max
A	0.70	0.75	0.80	D BSC		3.00	
A1	0.00	0.02	0.05	E BSC		3.00	
A3		0.20 REF		D2	2.20		2.70
L1	0.03		0.15	E2	1.40		1.75
L2			0.13	L	0.30	0.40	0.50
aaa		0.15		K	0.20		
bbb		0.10		b	0.18	0.25	0.30
ccc		0.10		e		0.50	
ddd		0.05		N		10	
eee		0.08		ND		5	
ggg		0.10		$\theta$	0°		14°

### Note:

- Figure 26 is shown for illustration only.
- All dimensions are in millimeters, angle is in degrees.
- Dimensioning and tolerancing conform to ASME Y14.5M-1994.
- N is the total number of terminals.
- Terminal #1 identifier and terminal numbering convention shall conform to JESD 95-1 SPP-012. Details of terminal #1 identifier are optional, but must be located within the area indicated. The terminal #1 identifier may be either a mold, embedded metal or mark feature.
- Dimension b applies to metallized terminal and is measured between 0.15 and 0.30mm from terminal tip.
- ND refers to the maximum number of terminals on D side.
- Unilateral coplanarity zone applies to the exposed heat sink slug as well as the terminals.

## 11 Ordering Information

The device is available as the standard products shown in [Table 8](#).

Table 8. Ordering Information

Ordering Code	Marking	Output	Description	Delivery Form	Package
AS1331-BTDT-AD	ASRP	adjustable	300mA Buck-Boost Synchronous DC/DC Converters	Tape and Reel	10-pin 3x3mm TDFN
AS1331-BTDT-25*	ASRR	2.5V	300mA Buck-Boost Synchronous DC/DC Converters	Tape and Reel	10-pin 3x3mm TDFN
AS1331-BTDT-30*	ASRT	3.0V	300mA Buck-Boost Synchronous DC/DC Converters	Tape and Reel	10-pin 3x3mm TDFN
AS1331-BTDT-33	ASRU	3.3V	300mA Buck-Boost Synchronous DC/DC Converters	Tape and Reel	10-pin 3x3mm TDFN

\* on request

**Note:** All products are RoHS compliant and Pb-free.

Buy our products or get free samples online at ICdirect: <http://www.austriamicrosystems.com/ICdirect>

For further information and requests, please contact us <mailto:sales@austriamicrosystems.com> or find your local distributor at <http://www.austriamicrosystems.com/distributor>



## Copyrights

Copyright © 1997-2010, austriamicrosystems AG, Tobelbaderstrasse 30, 8141 Unterpremstaetten, Austria-Europe. Trademarks Registered ®. All rights reserved. The material herein may not be reproduced, adapted, merged, translated, stored, or used without the prior written consent of the copyright owner.

All products and companies mentioned are trademarks or registered trademarks of their respective companies.

## Disclaimer

Devices sold by austriamicrosystems AG are covered by the warranty and patent indemnification provisions appearing in its Term of Sale. austriamicrosystems AG makes no warranty, express, statutory, implied, or by description regarding the information set forth herein or regarding the freedom of the described devices from patent infringement. austriamicrosystems AG reserves the right to change specifications and prices at any time and without notice. Therefore, prior to designing this product into a system, it is necessary to check with austriamicrosystems AG for current information. This product is intended for use in normal commercial applications. Applications requiring extended temperature range, unusual environmental requirements, or high reliability applications, such as military, medical life-support or life-sustaining equipment are specifically not recommended without additional processing by austriamicrosystems AG for each application. For shipments of less than 100 parts the manufacturing flow might show deviations from the standard production flow, such as test flow or test location.

The information furnished here by austriamicrosystems AG is believed to be correct and accurate. However, austriamicrosystems AG shall not be liable to recipient or any third party for any damages, including but not limited to personal injury, property damage, loss of profits, loss of use, interruption of business or indirect, special, incidental or consequential damages, of any kind, in connection with or arising out of the furnishing, performance or use of the technical data herein. No obligation or liability to recipient or any third party shall arise or flow out of austriamicrosystems AG rendering of technical or other services.



## Contact Information

### Headquarters

austriamicrosystems AG  
Tobelbaderstrasse 30  
A-8141 Unterpremstaetten, Austria

Tel: +43 (0) 3136 500 0  
Fax: +43 (0) 3136 525 01

For Sales Offices, Distributors and Representatives, please visit:

<http://www.austriamicrosystems.com/contact>