

HFD27

SUBMINIATURE DIP RELAY



File No.:E133481



File No.:R50075362



File No.:CQC09002033393



Features

- 2 Form C configuration
- High switching capacity: 125VA/60W
- Matching 16 pin IC socket
- Bifurcated contacts
- Epoxy sealed for automatic-wave soldering and cleaning
- Environmental friendly product (RoHS compliant)
- Outline Dimensions: (20.2 x 10.0 x 11.5) mm

CONTACT DATA

Contact arrangement	2C
Contact resistance	100mΩ max. (at 10mA 30mVDC)
Contact material	AgNi + Au plated
Contact rating (Res. load)	1A 125VAC, 2A 30VDC
Max. switching voltage	240VAC / 120VDC
Max. switching current	2A
Max. switching power	125VA / 60W
Min. applicable load ¹⁾	10mV 10μA
Mechanical endurance	1x10 ⁸ OPS
Electrical endurance ²⁾	1 x 10 ⁵ OPS (1A 125VAC, Resistive load, at 85°C, 1s on 9s off)

Notes: 1) Min. applicable load is reference value. Please perform the confirmation test with the actual load before production since reference value may change according to switching frequencies, environmental conditions and expected contact resistance and reliability.

2) Electric endurance data are collected in one pair CO contact test.

CHARACTERISTICS

Insulation resistance	1000MΩ (at 500VDC)
Dielectric strength	Between coil & contacts 1500VAC 1min
	Between open contacts M, S type: 1000VAC 1min H type: 750VAC 1min
Operate time (at nomi. volt.)	7ms max.
Release time (at nomi. volt.)	4ms max.
Ambient temperature	-40°C to 85°C
Humidity	5% to 85% RH
Vibration resistance	10Hz to 55Hz 1.5mm DA
Shock resistance	Functional 196m/s ²
	Destructive 980m/s ²
Termination	PCB (DIP)
Unit weight	Approx. 5g
Construction	Plastic sealed

Notes: 1) The data shown above are initial values.

2) UL insulation system: Class A

COIL

Coil power	Standard: Approx. 280mW to 580mW
	Sensitive: Approx. 200mW
	High Sensitive: Approx. 150mW
Temperature rise	65K max.

COIL DATA

at 23°C

Standard type (280mW to 580mW)

Coil Code	Coil Voltage VDC	Pick-up Voltage VDC max.	Drop-out Voltage VDC min.	Max. Voltage VDC	Coil Resistance Ω
003-M	3	2.25	0.3	4.5	30 x (1±10%)
005-M	5	3.75	0.5	8.0	90 x (1±10%)
006-M	6	4.50	0.6	10.0	130 x (1±10%)
009-M	9	6.80	0.9	14.5	280 x (1±10%)
012-M	12	9.00	1.2	18.5	450 x (1±10%)
015-M	15	11.3	1.5	22.0	625 x (1±10%)
024-M	24	18.0	2.4	35.5	1600 x (1±10%)
048-M	48	36.0	4.8	56.0	4000 x (1±10%)

Sensitive type (200mW)

Coil Code	Coil Voltage VDC	Pick-up Voltage VDC max.	Drop-out Voltage VDC min.	Max. Voltage VDC	Coil Resistance Ω
003-S	3	2.25	0.3	6	45 x (1±10%)
005-S	5	3.75	0.5	10	125 x (1±10%)
006-S	6	4.50	0.6	12	180 x (1±10%)
009-S	9	6.80	0.9	18	405 x (1±10%)
012-S	12	9.00	1.2	24	720 x (1±10%)
015-S	15	11.3	1.5	30	1125 x (1±10%)
024-S	24	18.0	2.4	48	2880 x (1±10%)



HONGFA RELAY

ISO9001, ISO/TS16949, ISO14001, OHSAS18001, IECQ QC 080000 CERTIFIED

2015 Rev. 1.00

COIL DATA at 23°C

High sensitive type (150mW)

Coil Code	Coil Voltage VDC	Pick-up Voltage VDC	Drop-out Voltage VDC	Max. Voltage VDC	Coil Resistance Ω
003-H	3	2.4	0.3	7.0	60 x (1±10%)
005-H	5	4.0	0.5	11.5	167 x (1±10%)
006-H	6	4.8	0.6	13.8	240 x (1±10%)
009-H	9	7.2	0.9	20.8	540 x (1±10%)
012-H	12	9.6	1.2	27.7	960 x (1±10%)
015-H	15	12.0	1.5	34.6	1500 x (1±10%)
024-H	24	19.2	2.4	55.2	3840 x (1±10%)

Notes: 1) When user's requirements can't be found in the above table, special order allowed.

2) In case 5V of transistor drive circuit, it is recommended to use 4.5V type relay, and 3V to use 2.4V type relay.

SAFETY APPROVAL RATINGS

UL/CUL	2A 30VDC
	1A 125VAC
TÜV	2A 30VDC
	1A 125VAC

Notes: 1) All values unspecified are at 85°C.

2) Only typical loads are listed above. Other load specifications can be available upon request.

ORDERING INFORMATION

Type	HFD27 / 012 -S (XXX)		
Coil voltage	3, 5, 6, 9, 12, 15, 24, 48VDC ¹⁾		
Coil power	M: Standard (280mW to 580mW) S: Sensitive (200mW) H: High sensitive (150mW)		
Special code ²⁾	XXX: Customer special requirement	Nil: Standard	

Notes: 1) 48VDC coil voltage is only for standard version.

2) The customer special requirement express as special code after evaluating by Hongfa.

OUTLINE DIMENSIONS, WIRING DIAGRAM AND PC BOARD LAYOUT

Unit: mm

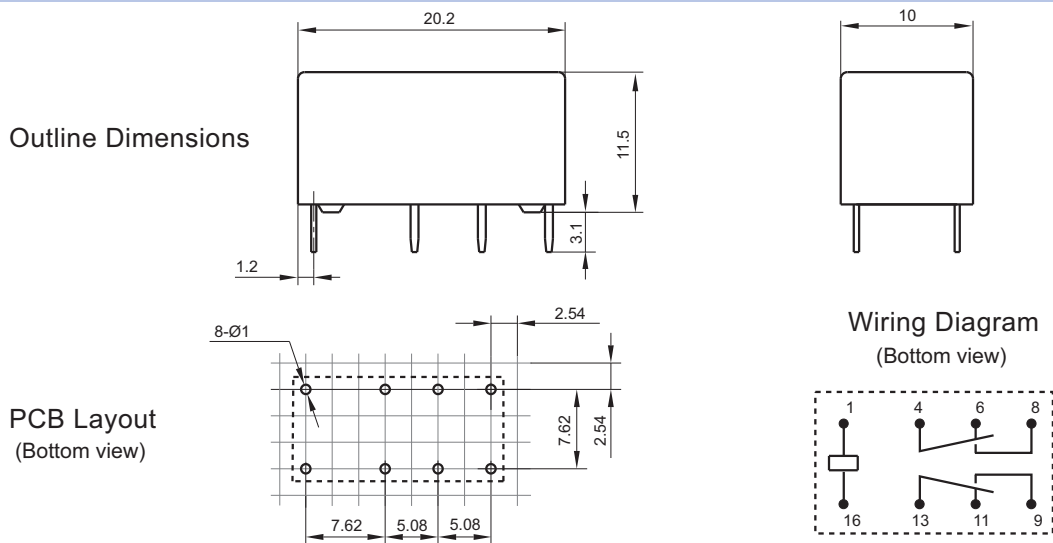

Remark: 1) In case of no tolerance shown in outline dimension: outline dimension ≤ 1 mm, tolerance should be ± 0.2 mm; outline dimension > 1 mm and ≤ 5 mm, tolerance should be ± 0.3 mm; outline dimension > 5 mm, tolerance should be ± 0.4 mm.

2) The tolerance without indicating for PCB layout is always ± 0.1 mm.

3) The width of the gridding is 2.54mm.

CHARACTERISTIC CURVES

MAXIMUM SWITCHING POWER

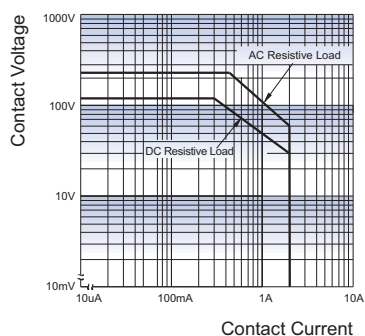

ENDURANCE CURVE

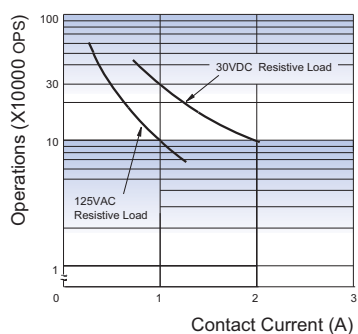

Test conditions:

Resistive load, at 85°C, 1s on 9s off.

Notice

- 1) To avoid using relays under strong magnetic field which will change the parameters of relays such as pick-up voltage and drop-out voltage.
- 2) The relay may be damaged because of falling or when shocking conditions exceed the requirement.
- 3) Contact is recommended for suitable condition and specifications if water cleaning or surface process is involved in assembling relays on PCB.
- 4) Regarding the plastic sealed relay, we should leave it cooling naturally until below 40°C after welding, then clean it and deal with coating, remarkably the temperature of solvents should also be controlled below 40°C. Please avoid cleaning the relay by ultrasonic, avoid using the solvents like gasoline, Freon, and so on, which would affect the configuration of relay or influence the environment.
- 5) Energizing coil with rated voltage is basic for normal operation of a relay, please make sure the energized voltage to relay coil have reached the rated voltage. Regarding latching relay, in order to maintain the "set" or "reset" status, impulse width of the rated voltage applied to coil should be more than 5 times of "set" or "reset" time.
- 6) About preferable condition of operation, storage and transportation, please refer to "Explanation to terminology and guidelines of relay".

Disclaimer

The specification is for reference only. See to "Terminology and Guidelines" for more information. Specifications subject to change without notice. We could not evaluate all the performance and all the parameters for every possible application. Thus the user should be in a right position to choose the suitable product for their own application. If there is any query, please contact Hongfa for the technical service. However, it is the user's responsibility to determine which product should be used only.

© Xiamen Hongfa Electroacoustic Co., Ltd. All rights of Hongfa are reserved.