

Surface Mount Aluminum Electrolytic Capacitors NAZJ Series

FEATURES

- CYLINDRICAL V-CHIP CONSTRUCTION FOR SURFACE MOUNTING
- REDUCED CASE SIZE (SMALLER THEN NAZT)
- LOW ESR & HIGH RIPPLE CURRENT AT 100KHz
- LOAD LIFE (2,000 HOURS @ +105°C)
- DESIGNED FOR AUTOMATIC MOUNTING AND REFLOW SOLDERING
- **MEETS THE REQUIREMENTS OF AEC-Q200***

SAC Alloy Compatible
235°C ~ 260°C



RoHS Compliant
includes all homogeneous materials

*Contact NIC for supporting test data

CHARACTERISTICS

*See Part Number System for Details

LOW ESR COMPONENT
LIQUID ELECTROLYTE
For Performance Data
see www.LowESR.com

Rated Voltage Rating	6.3 ~ 50Vdc						
Rated Capacitance Range	10 ~ 1,800µF						
Operating Temp. Range	-55 ~ +105°C						
Capacitance Tolerance	±20% (M)						
Max. Leakage Current After 2 Minutes @ 20°C	0.01CV or 3µA whichever is greater						
Dissipation Factor	W.V. (Vdc)	6.3	10	16	25	35	50
	S.V. (Vdc)	8.0	13	20	32	44	63
	Tan δ @ 120Hz/20°C	0.26	0.19	0.16	0.14	0.12	0.10
Low Temperature Stability Impedance Ratio @ 120Hz	W.V. (Vdc)	6.3	10	16	25	35	50
	Z-25°C/Z+20°C	2	2	2	2	2	2
	Z-40°C/Z+20°C	3	3	3	3	3	3
	Z-55°C/Z+20°C	4	4	4	3	3	3
Load Life Test @ 105°C 2,000 hours	Capacitance Change	Within ±30% of initial measured value					
	Tan δ	Less than ±200% of the specified maximum value					
	Leakage Current	Less than the specified maximum value					

STANDARD VALUES AND CASE SIZES (mm)

Cap. (µF)	Code	Working Voltage (Vdc)					
		6.3	10	16	25	35	50
10	100	-	-	4x6.1	4x6.1	4x6.1	-
22	220	4x6.1	4x6.1	4x6.1 5x6.1	5x6.1	5x6.1	-
33	330	-	4x6.1 5x6.1	-	5x6.1 6.3x6.1	6.3x6.1	-
47	470	4x6.1 5x6.1	-	5x6.1 6.3x6.1	6.3x6.1	6.3x6.1	-
68	680	-	-	6.3x6.1	6.3x6.1	6.3x8	-
100	101	5x6.1 6.3x6.1	-	6.3x6.1 6.3x8	6.3x8 8x6.5	6.3x8 8x10.5	8x10.5
150	151	-	6.3x6.1	6.3x8	8x10.5	8x10.5	-
220	221	6.3x6.1	6.3x8 8x6.5	6.3x8 8x6.5	8x10.5	8x10.5	10x10.5
330	331	6.3x8 8x6.5	8x10.5	8x10.5	8x10.5	10x10.5	-
390	391	-	-	-	-	10x10.5	-
470	471	8x10.5	8x10.5	8x10.5	10x10.5	-	-
560	561	-	-	-	10x10.5	-	-
680	681	-	8x10.5	10x10.5	-	-	-
820	821	-	-	10x10.5	-	-	-
1000	102	8x10.5	10x10.5	-	-	-	-
1200	122	-	10x10.5	-	-	-	-
1500	152	10x10.5	-	-	-	-	-
1800	182	10x10.5	-	-	-	-	-

PART NUMBER SYSTEM

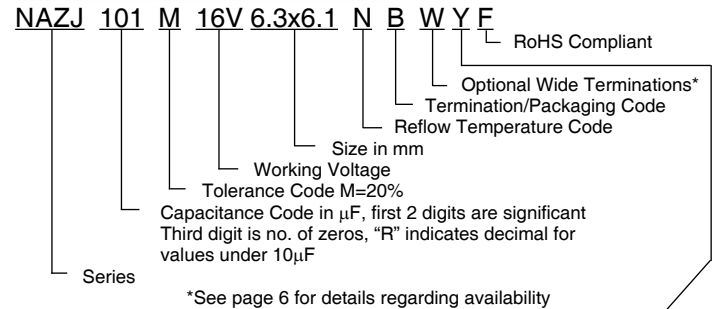

Optional: Suitable for automotive equipment, sourced to special production and inspection at TS-16949 certified production site

PEAK REFLOW TEMPERATURE CODES

Code	Peak Reflow Temperature
H	235°C
J	240°C
N	260°C*

TERMINATION FINISH & PACKAGING OPTIONS CODES

Code	Finish & Reel Size
B	Sn-Bi Finish & 13" Reel

*Special conditions apply for 8mm and 10mm diameter parts. See the 3rd page of this datasheet for details.

DIMENSIONS (mm) AND REEL QUANTITIES

Case Size	φD±0.5	L max.	A±0.2	B±0.2	I±0.3	W	P±0.3	Qty/Reel
4x6.1	4.0	6.1	4.3	4.3	1.8	0.55~0.75	1.0	1,200
5x6.1	5.0	6.1	5.3	5.3	2.2	0.55~0.75	1.5	800
6.3x6.1	6.3	6.1	6.6	6.6	2.6	0.55~0.75	1.8	800
6.3x8	6.3	8.0	6.6	6.6	2.6	0.55~0.75	1.8	500
8x6.5	8.0	6.5	8.3	8.3	3.4	0.55~0.75	2.2	800
8x10.5	8.0	10.5	8.3	8.3	2.9	0.8~1.1	3.1	300
8x10.5	8.0	10.5	8.3	8.3	3.4	0.7~1.1	3.1	300
10x10.5	10.0	10.5	10.3	10.3	3.2	0.8~1.1	4.6	300
10x10.5	10.0	10.5	10.3	10.3	3.5	0.7~1.1	4.6	300

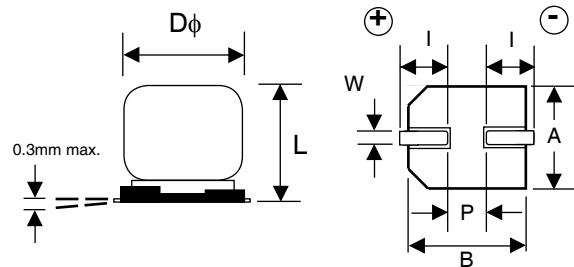

Surface Mount Aluminum Electrolytic Capacitors NAZJ Series

STANDARD VALUES, CASE SIZES AND SPECIFICATIONS

NIC Part Number	Cap. (µF)	W.V. (Vdc)	Dissipation Factor (Tan δ)	Max. ESR (Ω) 100KHz, +20°C	Max. Ripple Current (mA) +105°C, 100KHz	Load Life Hours @ +105°C	
NAZJ220M6.3V4X6.1NBF	22	6.3	0.26	0.85	160	2,000	
NAZJ470M6.3V4X6.1NBF	47		0.26	0.85	160	2,000	
NAZJ470M6.3V5X6.1NBF	47		0.26	0.36	240	2,000	
NAZJ101M6.3V5X6.1NBF	100		0.26	0.36	240	2,000	
NAZJ101M6.3V6.3X6.1NBF	100		0.26	0.26	300	2,000	
NAZJ221M6.3V6.3X6.1NBF	220		0.26	0.26	300	2,000	
NAZJ331M6.3V6.3X8NBF	330		0.26	0.16	600	2,000	
NAZJ331M6.3V8X6.5NBF	330		0.26	0.18	500	2,000	
NAZJ471M6.3V8X10.5JBF	470		0.26	0.08	850	2,000	
NAZJ471M6.3V8X10.5NBF	470		0.26	0.08	850	2,000	
NAZJ102M6.3V8X10.5JBF	1000		0.26	0.08	850	2,000	
NAZJ102M6.3V8X10.5NBF	1000		0.26	0.08	850	2,000	
NAZJ152M6.3V10X10.5HBF	1500		0.26	0.06	1190	2,000	
NAZJ152M6.3V10X10.5NBF	1500		0.26	0.06	1190	2,000	
NAZJ182M6.3V10X10.5HBF	1800		0.26	0.08	850	2,000	
NAZJ182M6.3V10X10.5NBF	1800		0.26	0.08	850	2,000	
NAZJ220M10V4X6.1NBF	22		10	0.19	0.85	160	2,000
NAZJ330M10V4X6.1NBF	33			0.19	0.85	160	2,000
NAZJ330M10V5X6.1NBF	33	0.19		0.36	240	2,000	
NAZJ151M10V6.3X6.1NBF	150	0.19		0.26	300	2,000	
NAZJ221M10V6.3X8NBF	220	0.19		0.16	600	2,000	
NAZJ221M10V8X6.5NBF	220	0.19		0.18	500	2,000	
NAZJ331M10V8X10.5JBF	330	0.19		0.08	850	2,000	
NAZJ331M10V8X10.5NBF	330	0.19		0.08	850	2,000	
NAZJ471M10V8X10.5JBF	470	0.19		0.08	850	2,000	
NAZJ471M10V8X10.5NBF	470	0.19		0.08	850	2,000	
NAZJ681M10V8X10.5JBF	680	0.19		0.08	850	2,000	
NAZJ681M10V8X10.5NBF	680	0.19		0.08	850	2,000	
NAZJ102M10V10X10.5HBF	1000	0.19		0.06	1190	2,000	
NAZJ102M10V10X10.5NBF	1000	0.19		0.06	1190	2,000	
NAZJ122M10V10X10.5HBF	1200	0.19		0.08	850	2,000	
NAZJ122M10V10X10.5NBF	1200	0.19		0.08	850	2,000	
NAZJ100M16V4X6.1NBF	10	16		0.16	0.85	160	2,000
NAZJ220M16V4X6.1NBF	22			0.16	0.85	160	2,000
NAZJ220M16V5X6.1NBF	22		0.16	0.36	240	2,000	
NAZJ470M16V5X6.1NBF	47		0.16	0.36	240	2,000	
NAZJ470M16V6.3X6.1NBF	47		0.16	0.26	300	2,000	
NAZJ680M16V6.3X6.1NBF	68		0.16	0.26	300	2,000	
NAZJ101M16V6.3X6.1NBF	100		0.16	0.26	300	2,000	
NAZJ101M16V6.3X8NBF	100		0.16	0.16	600	2,000	
NAZJ151M16V6.3X8NBF	150		0.16	0.16	600	2,000	
NAZJ221M16V6.3X8NBF	220		0.16	0.16	600	2,000	
NAZJ221M16V8X6.5NBF	220		0.16	0.18	500	2,000	
NAZJ331M16V8X10.5JBF	330		0.16	0.08	850	2,000	
NAZJ331M16V8X10.5NBF	330		0.16	0.08	850	2,000	
NAZJ471M16V8X10.5JBF	470		0.16	0.08	850	2,000	
NAZJ471M16V8X10.5NBF	470		0.16	0.08	850	2,000	
NAZJ681M16V10X10.5HBF	680		0.16	0.06	1190	2,000	
NAZJ681M16V10X10.5NBF	680		0.16	0.06	1190	2,000	
NAZJ821M16V10X10.5HBF	820		0.16	0.08	850	2,000	
NAZJ821M16V10X10.5NBF	820	0.16	0.08	850	2,000		
NAZJ100M25V4X6.1NBF	10	25	0.14	0.85	160	2,000	
NAZJ220M25V5X6.1NBF	22		0.14	0.36	240	2,000	
NAZJ330M25V5X6.1NBF	33		0.14	0.36	240	2,000	
NAZJ330M25V6.3X6.1NBF	33		0.14	0.26	300	2,000	
NAZJ470M25V6.3X6.1NBF	47		0.14	0.26	300	2,000	
NAZJ680M25V6.3X6.1NBF	68		0.14	0.26	300	2,000	
NAZJ101M25V6.3X8NBF	100		0.14	0.18	500	2,000	
NAZJ151M25V8X10.5NBF	150		0.14	0.08	850	2,000	
NAZJ221M25V8X10.5NBF	220	25	0.14	0.08	850	2,000	
NAZJ331M25V8X10.5NBF	330		0.14	0.08	850	2,000	
NAZJ471M25V8X10.5HBF	470		0.14	0.06	1190	2,000	
NAZJ471M25V8X10.5NBF	470		0.14	0.06	1190	2,000	
NAZJ561M25V10X10.5HBF	560		0.14	0.08	850	2,000	
NAZJ561M25V10X10.5NBF	560		0.14	0.08	850	2,000	
NAZJ100M35V4X6.1NBF	10		35	0.12	0.85	160	2,000
NAZJ220M35V5X6.1NBF	22			0.12	0.36	240	2,000
NAZJ330M35V6.3X6.1NBF	33			0.12	0.26	300	2,000
NAZJ470M35V6.3X6.1NBF	47			0.12	0.26	300	2,000
NAZJ680M35V6.3X8NBF	68			0.12	0.16	600	2,000
NAZJ101M35V6.3X8NBF	100			0.12	0.16	600	2,000
NAZJ101M35V8X10.5JBF	100			0.12	0.08	850	2,000
NAZJ101M35V8X10.5NBF	100			0.12	0.08	850	2,000
NAZJ151M35V8X10.5JBF	150			0.12	0.08	850	2,000
NAZJ151M35V8X10.5NBF	150			0.12	0.08	850	2,000
NAZJ221M35V8X10.5JBF	220			0.12	0.08	850	2,000
NAZJ221M35V8X10.5NBF	220			0.12	0.08	850	2,000
NAZJ331M35V10X10.5HBF	330	0.12		0.06	1190	2,000	
NAZJ331M35V10X10.5NBF	330	0.12		0.06	1190	2,000	
NAZJ391M35V10X10.5HBF	390	0.12		0.08	850	2,000	
NAZJ391M35V10X10.5NBF	390	0.12		0.08	850	2,000	
NAZJ101M50V8X10.5NBF	100	50		0.10	0.18	670	2,000
NAZJ221M50V10X10.5NBF	220			0.10	0.12	900	2,000

Denotes Lower Reflow Temperature Rated, Lower Cost Alternative

PRECAUTIONS

Please review the notes on correct use, safety and precautions found on pages T10 & T11 of NIC's Electrolytic Capacitor catalog. Also found at www.niccomp.com/precautions. If in doubt or uncertainty, please review your specific application - process details with NIC's technical support personnel: tpmg@niccomp.com



Surface Mount Aluminum Electrolytic Capacitors NAZJ Series

STANDARD VALUES, CASE SIZES AND SPECIFICATIONS

NIC Part Number	Cap. (µF)	W.V. (Vdc)	Dissipation Factor (Tan δ)	Max. ESR (Ω) 100KHz, +20°C	Max. Ripple Current (mA) +105°C, 100KHz	Load Life Hours @ +105°C	
NAZJ101M25V6.3X8NBF	100	25	0.14	0.16	600	2,000	
NAZJ101M25V8X6.5NBF	100		0.14	0.18	500	2,000	
NAZJ151M25V8X10.5JBF	150		0.14	0.08	850	2,000	
NAZJ151M25V8X10.5NBF	150		0.14	0.08	850	2,000	
NAZJ221M25V8X10.5JBF	220		0.14	0.08	850	2,000	
NAZJ221M25V8X10.5NBF	220		0.14	0.08	850	2,000	
NAZJ331M25V8X10.5JBF	330		0.14	0.08	850	2,000	
NAZJ331M25V8X10.5NBF	330		0.14	0.08	850	2,000	
NAZJ471M25V10X10.5HBF	470		0.14	0.06	1190	2,000	
NAZJ471M25V10X10.5NBF	470		0.14	0.06	1190	2,000	
NAZJ561M25V10X10.5HBF	560		0.14	0.08	850	2,000	
NAZJ561M25V10X10.5NBF	560		0.14	0.08	850	2,000	
NAZJ100M35V4X6.1NBF	10		35	0.12	0.85	160	2,000
NAZJ220M35V5X6.1NBF	22			0.12	0.36	240	2,000
NAZJ330M35V6.3X6.1NBF	33			0.12	0.26	300	2,000
NAZJ470M35V6.3X6.1NBF	47			0.12	0.26	300	2,000
NAZJ680M35V6.3X8NBF	68			0.12	0.16	600	2,000
NAZJ101M35V6.3X8NBF	100			0.12	0.16	600	2,000
NAZJ101M35V8X10.5JBF	100	0.12		0.08	850	2,000	
NAZJ101M35V8X10.5NBF	100	0.12		0.08	850	2,000	
NAZJ151M35V8X10.5JBF	150	0.12		0.08	850	2,000	
NAZJ151M35V8X10.5NBF	150	0.12		0.08	850	2,000	
NAZJ221M35V8X10.5JBF	220	0.12		0.08	850	2,000	
NAZJ221M35V8X10.5NBF	220	0.12		0.08	850	2,000	
NAZJ331M35V10X10.5HBF	330	0.12		0.06	1190	2,000	
NAZJ331M35V10X10.5NBF	330	0.12		0.06	1190	2,000	
NAZJ391M35V10X10.5HBF	390	0.12		0.08	850	2,000	
NAZJ391M35V10X10.5NBF	390	0.12		0.08	850	2,000	
NAZJ101M50V8X10.5NBF	100	50		0.10	0.18	670	2,000
NAZJ221M50V10X10.5NBF	220			0.10	0.12	900	2,000

Denotes Lower Reflow Temperature Rated, Lower Cost Alternative

RIPPLE CURRENT FREQUENCY CORRECTION FACTOR (STANDARD)

Frequency	120Hz	1KHz	10KHz	100KHz ~
10 ~ 470µF	0.65	0.85	0.95	1.00
560 ~ 1800µF	0.75	0.90	0.95	1.00

RIPPLE CURRENT FREQUENCY CORRECTION FACTOR (ALTERNATIVE PART)

Frequency	120Hz	1KHz	10KHz	100KHz ~
100 ~ 150µF	0.50	0.80	0.95	1.00
220 ~ 1800µF	0.60	0.85	0.95	1.00

Review & Compare Reflow Soldering Heat Limits V-chip SMT Aluminum Electrolytic Capacitors www.niccomp.com/RSL



PEAK REFLOW TEMPERATURE, DURATION AND NUMBER OF REFLOW PASSES ALLOWED

Diameter	Reflow Code	Peak Temperature	Duration	Time above 200°C	Time above 217°C	Time above 230°C	Number of Reflow Passes
4 ~ 6.3mm ϕ	N	+260°C	Time \geq 250°C 5 sec.	70 sec.	40 sec.	30 sec.	2
	N	+255°C	Time \geq 250°C 10 sec.	70 sec.	40 sec.	30 sec.	2
8mm ϕ	J	+240°C	Time \geq 240°C 5 sec.	90 sec.	n/a	30 sec.	2
10mm ϕ	H	+235°C	Time \geq 235°C 5 sec.	60 sec.	n/a	30 sec.	2
8 ~ 10mm ϕ (see note 1)	N	+260°C	Time \geq 250°C 5 sec.	70 sec.	40 sec.	30 sec.	1 only
	N	+245°C	Time \geq 240°C 10 sec.	70 sec.	40 sec.	30 sec.	2

- Only one (1) reflow pass is allowed for 8mm and 10mm diameter parts (N reflow code) if the peak reflow temperature is +260°C.
- In situations where two reflow passes is allowed the second reflow shall be at least one hour after natural cool to room temperature has occurred.

RECOMMENDED LAND PATTERN DIMENSIONS (mm)

Case Size	a	b	c
4x6.1	1.0	2.5	1.6
5x6.1	1.5	2.8	1.6
6x3x6.1 6.3x8	1.8	3.2	1.6
8x6.5	2.2	4.0	1.6
8x10.5	3.0	4.1	2.2
8x10.5	3.1	4.0	2.0
10x10.5	4.5	4.3	2.2
10x10.5	4.6	4.1	2.0

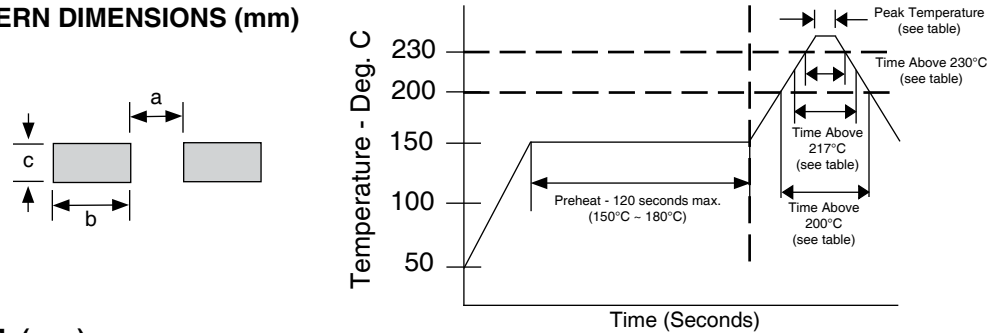

WIDE TERMINATION (WT) DIM. (mm)

Case Size	D ϕ \pm 0.5	L \pm 0.3	A, B \pm 0.2	C max.	P ref.	I ref.	W	R \pm 0.2	R \pm 0.2	T \pm 0.2
8x6.5	8.0	6.5	8.3	9.5	(2.2)	3.4	0.7 \pm 0.1	0.7	5.3	1.7
8x10.5	8.0	10.5	8.3	10.0	(3.1)	3.4	1.2 \pm 0.2	0.7	5.3	1.3
10x10.5	10.0	10.5	10.3	12.0	(4.6)	3.4	1.2 \pm 0.2	0.7	6.9	1.3

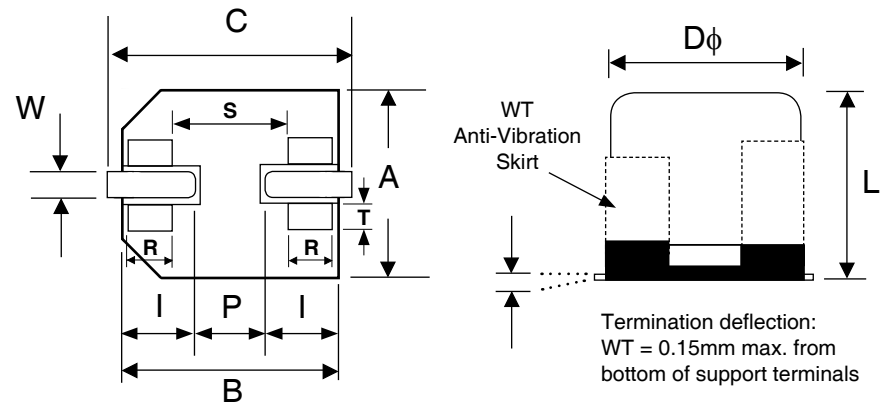

WT LAND PATTERN DIM. (mm)

Case Size	a	b	c
8x6.5	1.8	4.1	5.0
8x10.5	2.7	4.0	4.7
10x10.5	3.9	4.4	4.7

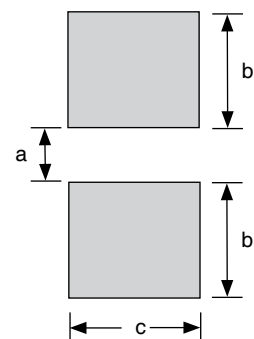

WT LAND PATTERN DIM. (mm)

Case Size	a	b	c	d	e	f	g	h
8x6.5	1.8	4.1	5.0	1.3	1.5	1.4	1.5	2.0
8x10.5	2.7	4.0	4.7	1.3	1.0	1.7	1.1	2.5
10x10.5	3.9	4.4	4.7	1.3	1.2	1.9	1.1	2.5

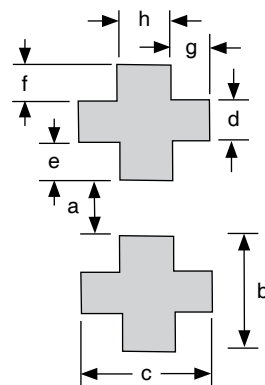

CARRIER TAPE

Case Size	A \pm 0.5	B \pm 0.2	C \pm 0.3	D \pm 0.1	P \pm 0.1	T \pm 0.2
4 x 6.1	4.7	4.7	12.0	5.5	8.0	6.2
5 x 6.1	5.7	5.7	12.0	5.5	12.0	6.4
6.3 x 6.1	7.0	7.0	16.0	7.5	12.0	6.4
6.3 x 8	7.0	7.0	16.0	7.5	12.0	8.4
8 x 6.5	8.7	8.7	16.0	7.5	12.0	6.8
8 X 10.5	8.7	8.7	24.0	11.5	16.0	11.0
10 x 10.5	10.7	10.7	24.0	11.5	16.0	11.0

TR13 330mm (13") REEL TR15 380mm (15") REEL

Case Size	W \pm 1.0	Quantity Per Reel
		13" Reel
4 x 6.1	14.0	1,200 pcs
5 x 6.1	14.0	800 pcs
6.3 x 6.1	18.0	800 pcs
6.3 x 8	18.0	500 pcs
8 x 6.5	18.0	800 pcs
8 X 10.5	26.0	300 pcs
10 x 10.5	26.0	300 pcs

TAPING SPECIFICATIONS (mm)

- Both Leader and Trailer tape: Minimum 40mm (1.57") empty carrier tape pockets.
- Leader tape: Approximately 20cm of cover tape at leader.
- Connection: Maximum 3 connections (slices) per reel.

CARRIER

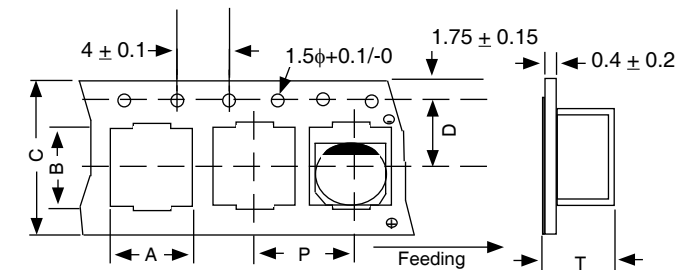

REEL

