

**INSULATED GATE BIPOLAR TRANSISTOR WITH
ULTRAFAST SOFT RECOVERY DIODE**

Features

- Low $V_{CE(on)}$ Trench IGBT Technology
- Low Switching Losses
- 5 μ s SCSOA
- Square RBSOA
- 100% of The Parts Tested for I_{LM} ①
- Positive $V_{CE(on)}$ Temperature Coefficient.
- Ultra Fast Soft Recovery Co-pak Diode
- Tighter Distribution of Parameters
- Lead-Free, RoHS Compliant

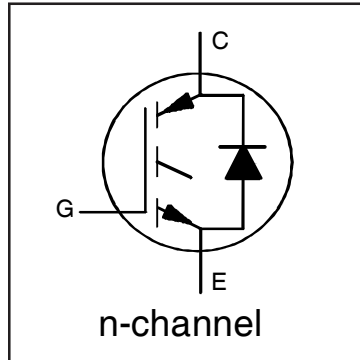

$V_{CES} = 600V$
$I_{C(Nominal)} = 120A$
$t_{SC} \geq 5\mu s, T_{J(max)} = 175^{\circ}C$
$V_{CE(on)} \text{ typ.} = 1.70V$

Benefits

- High Efficiency in a Wide Range of Applications
- Suitable for a Wide Range of Switching Frequencies due to Low $V_{CE(ON)}$ and Low Switching Losses
- Rugged Transient Performance for Increased Reliability
- Excellent Current Sharing in Parallel Operation
- Low EMI

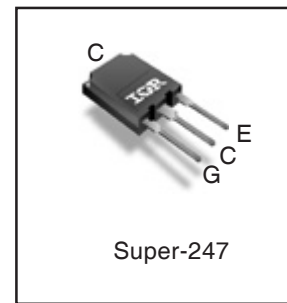

G	C	E
Gate	Collector	Emitter

Absolute Maximum Ratings

	Parameter	Max.	Units
V_{CES}	Collector-to-Emitter Voltage	600	V
$I_C @ T_C = 25^{\circ}C$	Continuous Collector Current	240 ^③	A
$I_C @ T_C = 100^{\circ}C$	Continuous Collector Current	160 ^③	
$I_{NOMINAL}$	Nominal Current	120	
I_{CM}	Pulse Collector Current, $V_{GE} = 15V$	360	
I_{LM}	Clamped Inductive Load Current, $V_{GE} = 20V$ ①	480	
$I_F @ T_C = 25^{\circ}C$	Diode Continuous Forward Current	240	
$I_F @ T_C = 100^{\circ}C$	Diode Continuous Forward Current	160	
I_{FM}	Diode Maximum Forward Current ②	480	
V_{GE}	Continuous Gate-to-Emitter Voltage	± 20	
	Transient Gate-to-Emitter Voltage	± 30	
$P_D @ T_C = 25^{\circ}C$	Maximum Power Dissipation	750	W
		375	
T_J T_{STG}	Operating Junction and Storage Temperature Range	-55 to +175	$^{\circ}C$

Thermal Resistance

	Parameter	Min.	Typ.	Max.	Units
$R_{\theta JC}$ (IGBT)	Thermal Resistance Junction-to-Case-(each IGBT) ④	—	—	0.20	$^{\circ}C/W$
$R_{\theta JC}$ (Diode)	Thermal Resistance Junction-to-Case-(each Diode) ④	—	—	0.63	
$R_{\theta CS}$	Thermal Resistance, Case-to-Sink (flat, greased surface)	—	0.24	—	
$R_{\theta JA}$	Thermal Resistance, Junction-to-Ambient (typical socket mount)	—	—	40	

Electrical Characteristics @ T_J = 25°C (unless otherwise specified)

	Parameter	Min.	Typ.	Max.	Units	Conditions
V _{(BR)CES}	Collector-to-Emitter Breakdown Voltage	600	—	—	V	V _{GE} = 0V, I _C = 100μA ^③
ΔV _{(BR)CES} /ΔT _J	Temperature Coeff. of Breakdown Voltage	—	0.27	—	V/°C	V _{GE} = 0V, I _C = 4.0mA (25°C-175°C)
V _{CE(on)}	Collector-to-Emitter Saturation Voltage	—	1.70	2.05	V	I _C = 120A, V _{GE} = 15V, T _J = 25°C
		—	2.15	—		I _C = 120A, V _{GE} = 15V, T _J = 150°C
		—	2.20	—		I _C = 120A, V _{GE} = 15V, T _J = 175°C
V _{GE(th)}	Gate Threshold Voltage	4.0	—	6.5	V	V _{CE} = V _{GE} , I _C = 5.6mA
ΔV _{GE(th)} /ΔT _J	Threshold Voltage temp. coefficient	—	-17	—	mV/°C	V _{CE} = V _{GE} , I _C = 5.6mA (25°C - 175°C)
g _f	Forward Transconductance	—	77	—	S	V _{CE} = 50V, I _C = 120A
I _{CES}	Collector-to-Emitter Leakage Current	—	1.0	150	μA	V _{GE} = 0V, V _{CE} = 600V
		—	2.3	—	mA	V _{GE} = 0V, V _{CE} = 600V, T _J = 175°C
V _{FM}	Diode Forward Voltage Drop	—	2.4	3.0	V	I _F = 120A
		—	1.9	—		I _F = 120A, T _J = 175°C
I _{GES}	Gate-to-Emitter Leakage Current	—	—	±400	nA	V _{GE} = ±20V

Switching Characteristics @ T_J = 25°C (unless otherwise specified)

	Parameter	Min.	Typ.	Max. ⑥	Units	Conditions
Q _g	Total Gate Charge (turn-on)	—	240	360	nC	I _C = 120A
Q _{ge}	Gate-to-Emitter Charge (turn-on)	—	70	105		V _{GE} = 15V
Q _{gc}	Gate-to-Collector Charge (turn-on)	—	90	135		V _{CC} = 400V
E _{on}	Turn-On Switching Loss	—	5750	7990	μJ	I _C = 120A, V _{CC} = 400V, V _{GE} = 15V
E _{off}	Turn-Off Switching Loss	—	3430	4360		R _G = 4.7Ω, L = 66μH, T _J = 25°C
E _{total}	Total Switching Loss	—	9180	12350		Energy losses include tail & diode reverse recovery
t _{d(on)}	Turn-On delay time	—	80	100	ns	I _C = 120A, V _{CC} = 400V, V _{GE} = 15V
t _r	Rise time	—	70	125		R _G = 4.7Ω, L = 66μH, T _J = 25°C
t _{d(off)}	Turn-Off delay time	—	190	220		
t _f	Fall time	—	40	60		
E _{on}	Turn-On Switching Loss	—	7740	—		μJ
E _{off}	Turn-Off Switching Loss	—	4390	—	R _G = 4.7Ω, L = 66μH, T _J = 175°C	
E _{total}	Total Switching Loss	—	12130	—	Energy losses include tail & diode reverse recovery	
t _{d(on)}	Turn-On delay time	—	80	—	ns	I _C = 120A, V _{CC} = 400V, V _{GE} = 15V
t _r	Rise time	—	75	—		R _G = 4.7Ω, L = 66μH
t _{d(off)}	Turn-Off delay time	—	230	—		T _J = 175°C
t _f	Fall time	—	55	—		
C _{ies}	Input Capacitance	—	7750	—	pF	V _{GE} = 0V
C _{oes}	Output Capacitance	—	550	—		V _{CC} = 30V
C _{res}	Reverse Transfer Capacitance	—	225	—		f = 1.0Mhz
RBSOA	Reverse Bias Safe Operating Area	FULL SQUARE				T _J = 175°C, I _C = 480A V _{CC} = 480V, V _p = 600V R _G = 4.7Ω, V _{GE} = +20V to 0V
SCSOA	Short Circuit Safe Operating Area	5	—	—	μs	V _{CC} = 400V, V _p = 600V R _G = 4.7Ω, V _{GE} = +15V to 0V
E _{rec}	Reverse Recovery Energy of the Diode	—	500	—	μJ	T _J = 175°C
t _{rr}	Diode Reverse Recovery Time	—	130	—	ns	V _{CC} = 400V, I _F = 120A
I _{rr}	Peak Reverse Recovery Current	—	36	—	A	V _{GE} = 15V, R _G = 4.7Ω, L = 100μH

Notes:

- ① V_{CC} = 80% (V_{CES}), V_{GE} = 20V, L = 66μH, R_G = 4.7Ω, tested in production I_{LM} ≤ 400A.
- ② Pulse width limited by max. junction temperature.
- ③ Refer to AN-1086 for guidelines for measuring V_{(BR)CES} safely.
- ④ R_θ is measured at T_J of approximately 90°C.
- ⑤ Calculated continuous current based on maximum allowable junction temperature. Package IGBT current limit is 195A. Package diode current limit is 120A. Note that current limitations arising from heating of the device leads may occur.
- ⑥ Maximum limits are based on statistical sample size characterization.

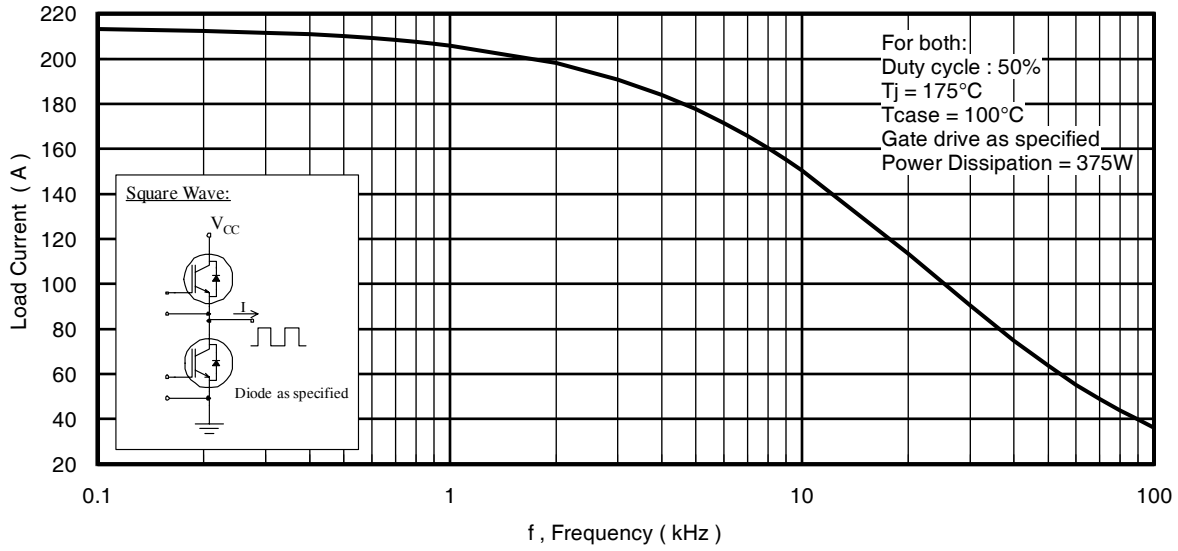

Fig. 1 - Typical Load Current vs. Frequency
(Load Current = I_{RMS} of fundamental)

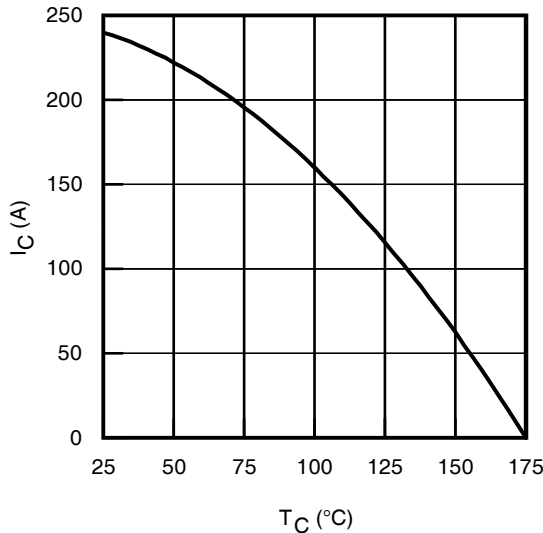

Fig. 2 - Maximum DC Collector Current vs. Case Temperature

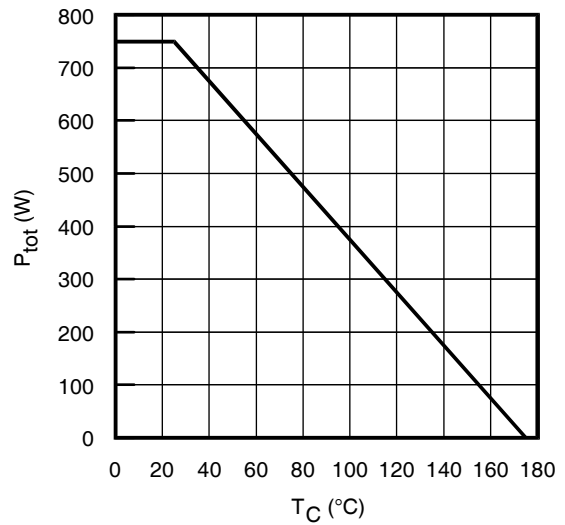

Fig. 3 - Power Dissipation vs. Case Temperature

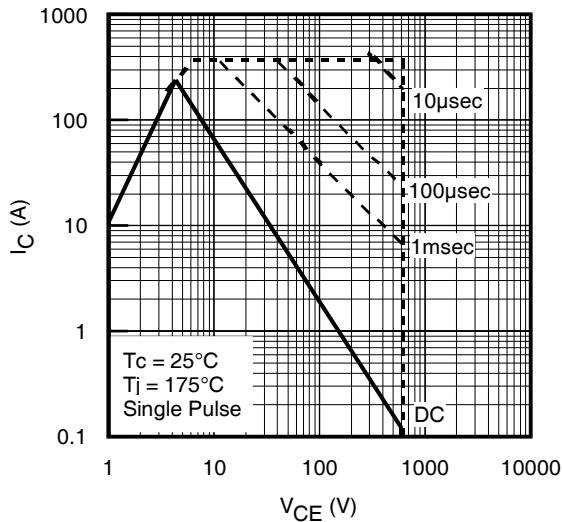

Fig. 4 - Forward SOA
 $T_C = 25^\circ\text{C}$, $T_J \leq 175^\circ\text{C}$; $V_{GE} = 15\text{V}$

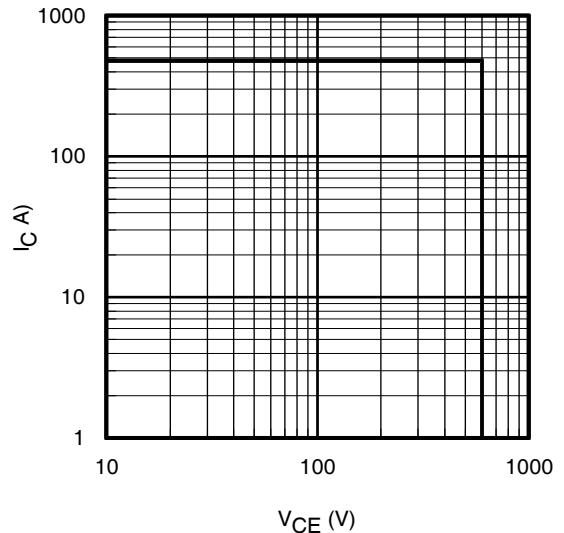

Fig. 5 - Reverse Bias SOA
 $T_J = 175^\circ\text{C}$; $V_{GE} = 20\text{V}$

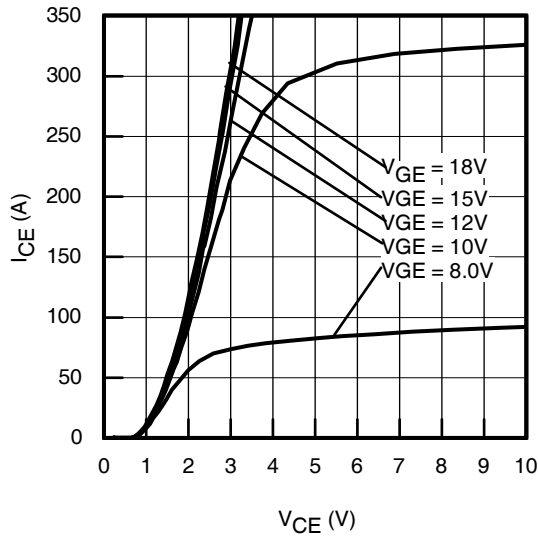

Fig. 6 - Typ. IGBT Output Characteristics
 $T_J = -40^\circ\text{C}$; $t_p = 80\mu\text{s}$

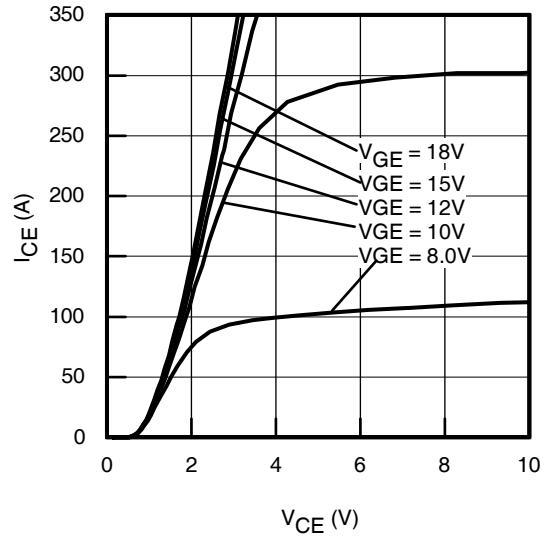

Fig. 7 - Typ. IGBT Output Characteristics
 $T_J = 25^\circ\text{C}$; $t_p = 80\mu\text{s}$

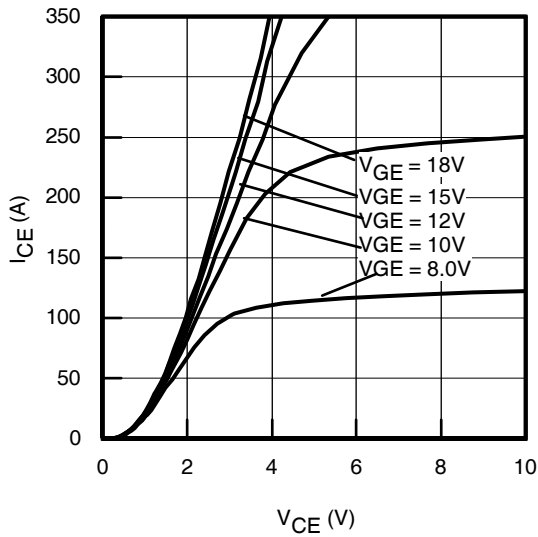

Fig. 8 - Typ. IGBT Output Characteristics
 $T_J = 175^\circ\text{C}$; $t_p = 80\mu\text{s}$

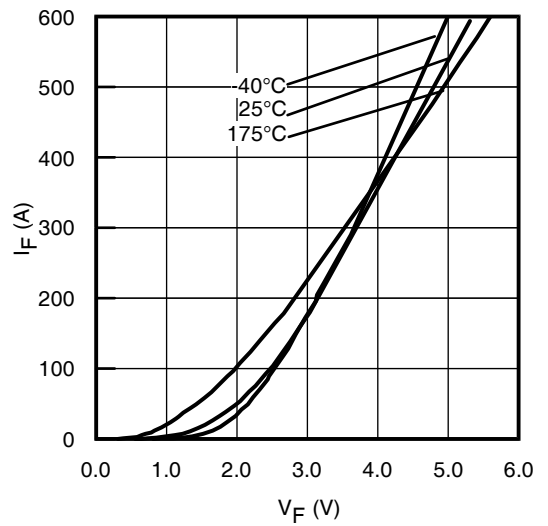

Fig. 9 - Typ. Diode Forward Characteristics
 $t_p = 80\mu\text{s}$

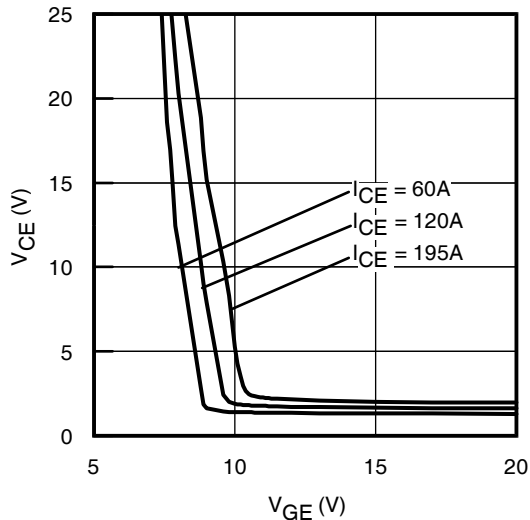

Fig. 10 - Typical V_{CE} vs. V_{GE}
 $T_J = -40^\circ\text{C}$

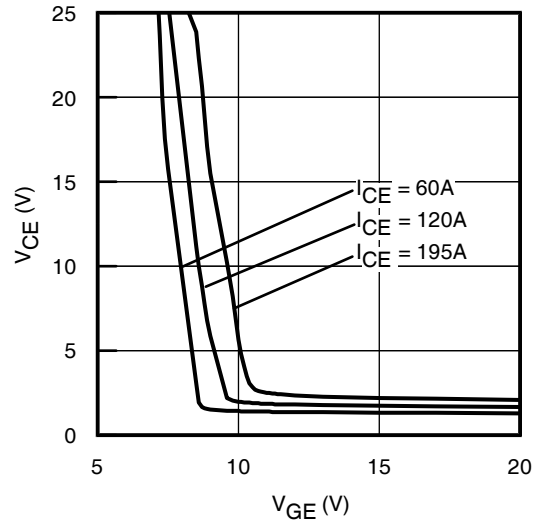

Fig. 11 - Typical V_{CE} vs. V_{GE}
 $T_J = 25^\circ\text{C}$

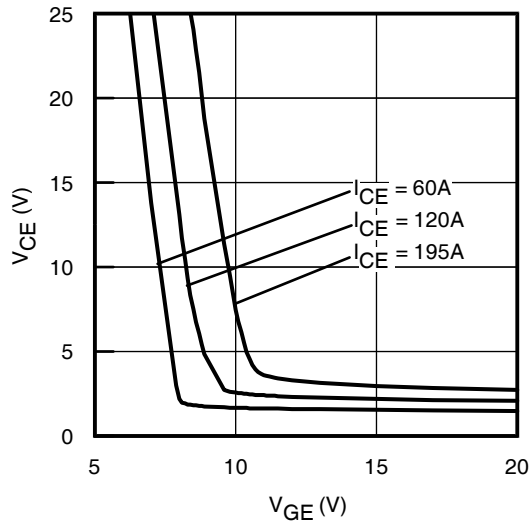

Fig. 12 - Typical V_{CE} vs. V_{GE}
 $T_J = 175^\circ\text{C}$

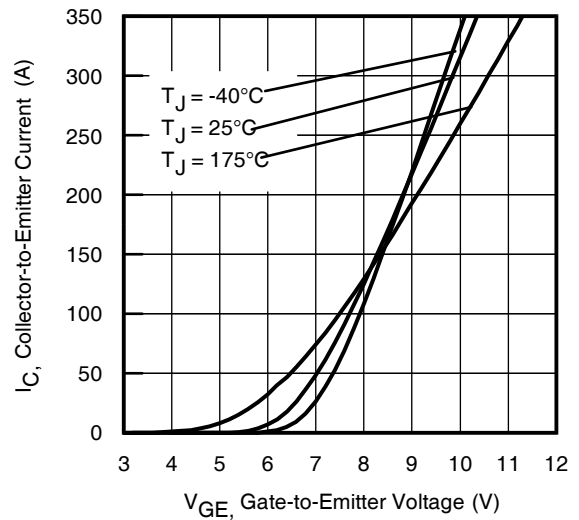

Fig. 13 - Typ. Transfer Characteristics
 $V_{CE} = 50\text{V}$; $t_p = 10\mu\text{s}$

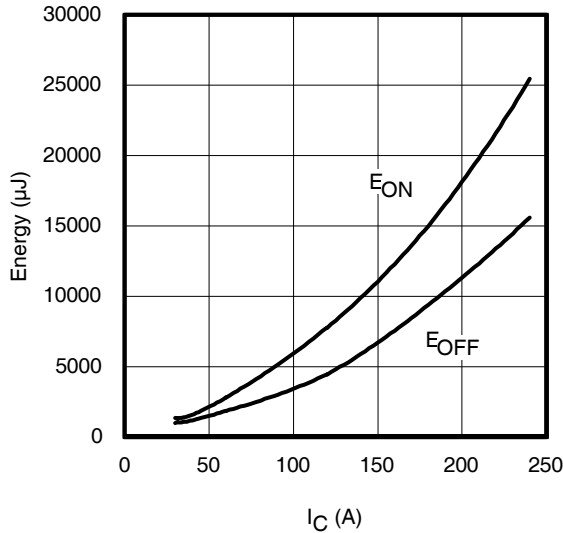

Fig. 14 - Typ. Energy Loss vs. I_C
 $T_J = 175^\circ\text{C}$; $L = 66\mu\text{H}$; $V_{CE} = 400\text{V}$, $R_G = 4.7\Omega$; $V_{GE} = 15\text{V}$

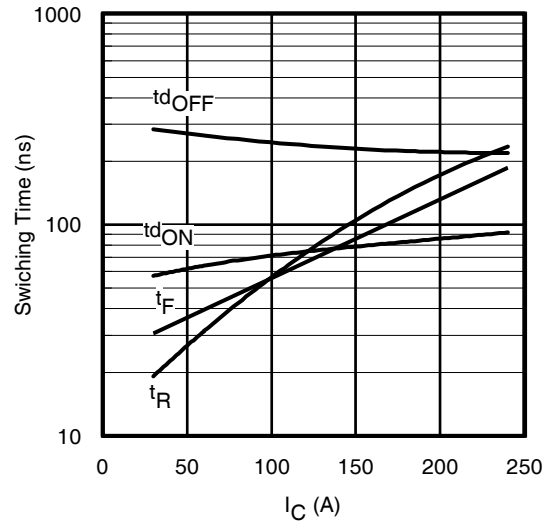

Fig. 15 - Typ. Switching Time vs. I_C
 $T_J = 175^\circ\text{C}$; $L = 66\mu\text{H}$; $V_{CE} = 400\text{V}$, $R_G = 4.7\Omega$; $V_{GE} = 15\text{V}$

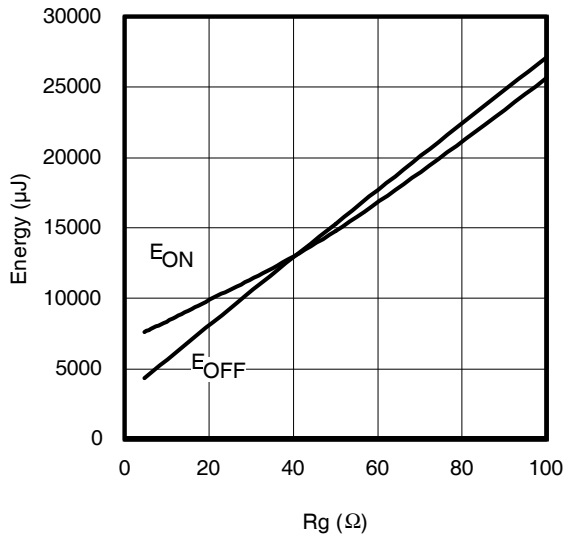

Fig. 16 - Typ. Energy Loss vs. R_G
 $T_J = 175^\circ\text{C}$; $L = 66\mu\text{H}$; $V_{CE} = 400\text{V}$, $I_{CE} = 120\text{A}$; $V_{GE} = 15\text{V}$

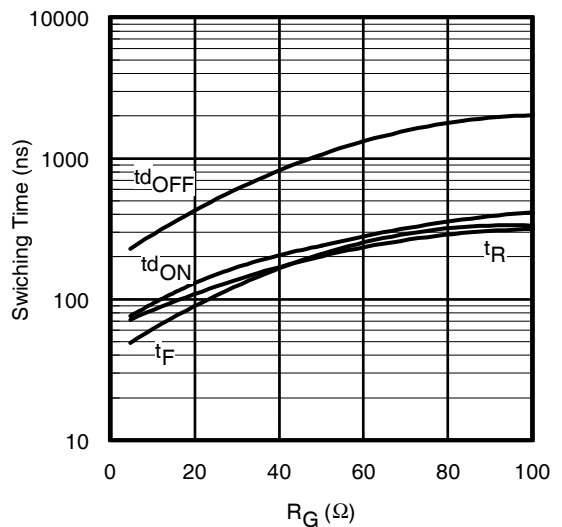

Fig. 17 - Typ. Switching Time vs. R_G
 $T_J = 175^\circ\text{C}$; $L = 66\mu\text{H}$; $V_{CE} = 400\text{V}$, $I_{CE} = 120\text{A}$; $V_{GE} = 15\text{V}$

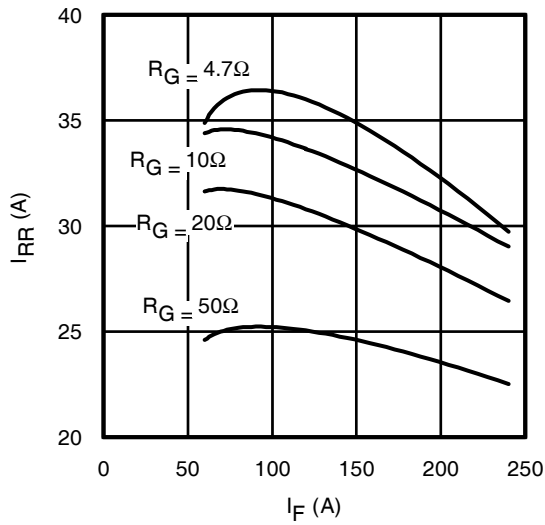

Fig. 18 - Typ. Diode I_{RR} vs. I_F
 $T_J = 175^\circ\text{C}$

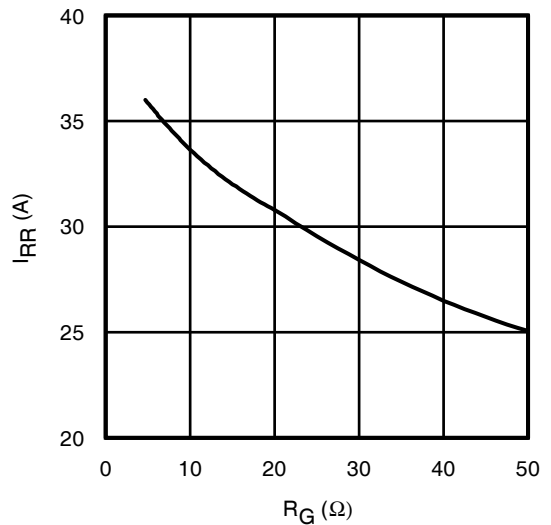

Fig. 19 - Typ. Diode I_{RR} vs. R_G
 $T_J = 175^\circ\text{C}$

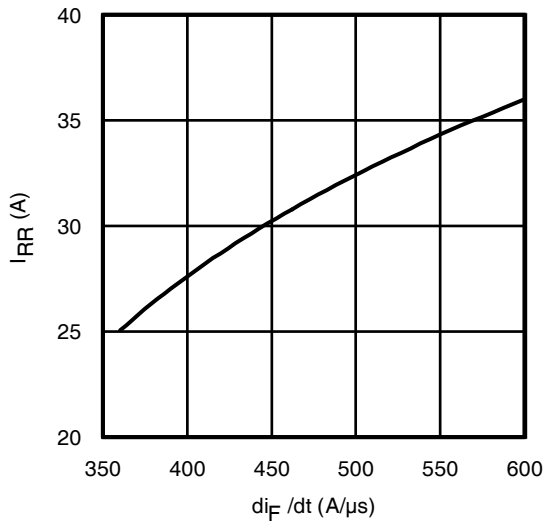

Fig. 20 - Typ. Diode I_{RR} vs. di_F/dt
 $V_{CC} = 400\text{V}$; $V_{GE} = 15\text{V}$; $I_F = 120\text{A}$; $T_J = 175^\circ\text{C}$

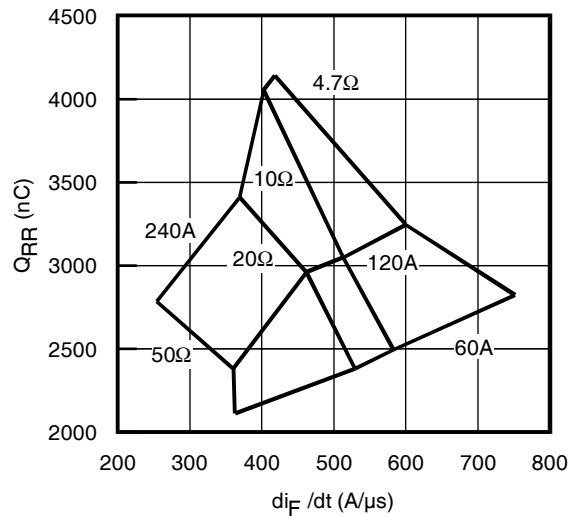

Fig. 21 - Typ. Diode Q_{RR} vs. di_F/dt
 $V_{CC} = 400\text{V}$; $V_{GE} = 15\text{V}$; $T_J = 175^\circ\text{C}$

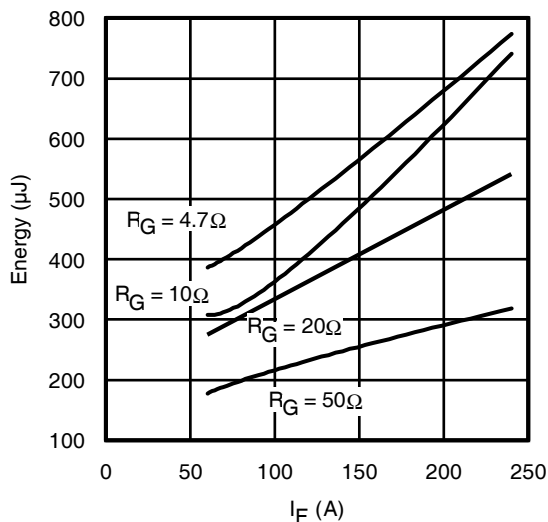

Fig. 22 - Typ. Diode E_{RR} vs. I_F
 $T_J = 175^\circ\text{C}$

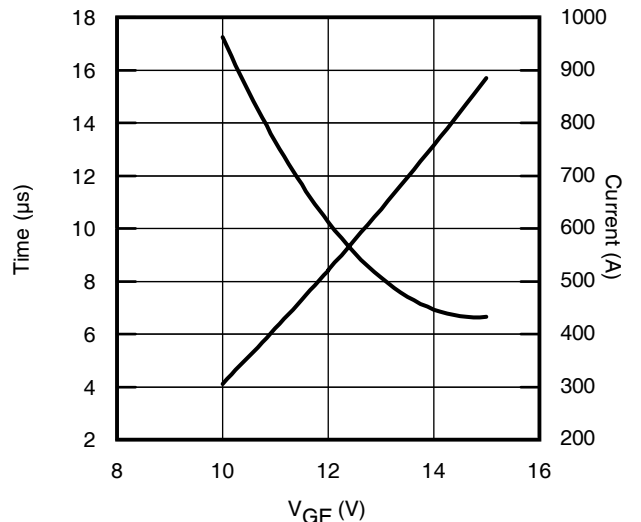

Fig. 23 - V_{GE} vs. Short Circuit Time
 $V_{CC} = 400\text{V}$; $T_C = 25^\circ\text{C}$

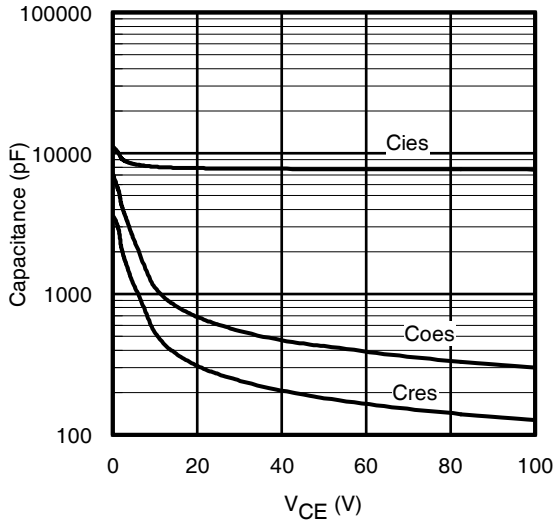

Fig. 24 - Typ. Capacitance vs. V_{CE}
 $V_{GE} = 0V$; $f = 1MHz$

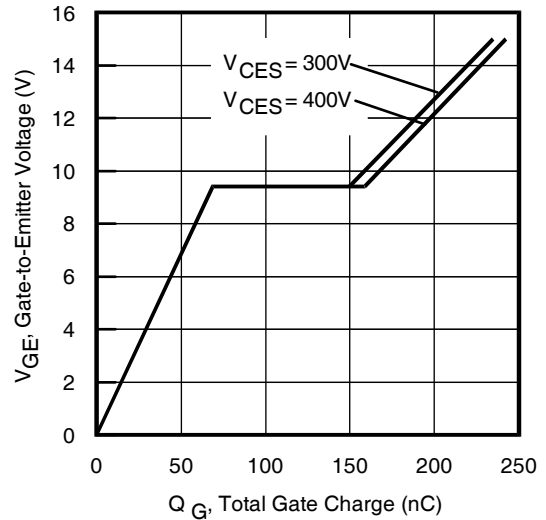

Fig. 25 - Typical Gate Charge vs. V_{GE}
 $I_{CE} = 120A$; $L = 100\mu H$

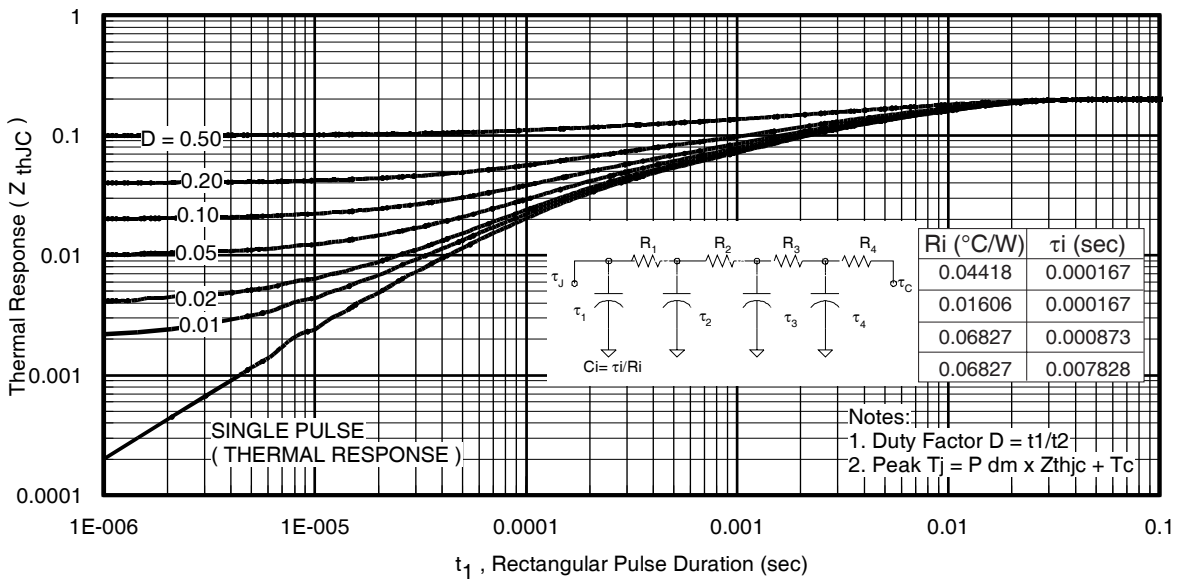

Fig. 26. Maximum Transient Thermal Impedance, Junction-to-Case (IGBT)

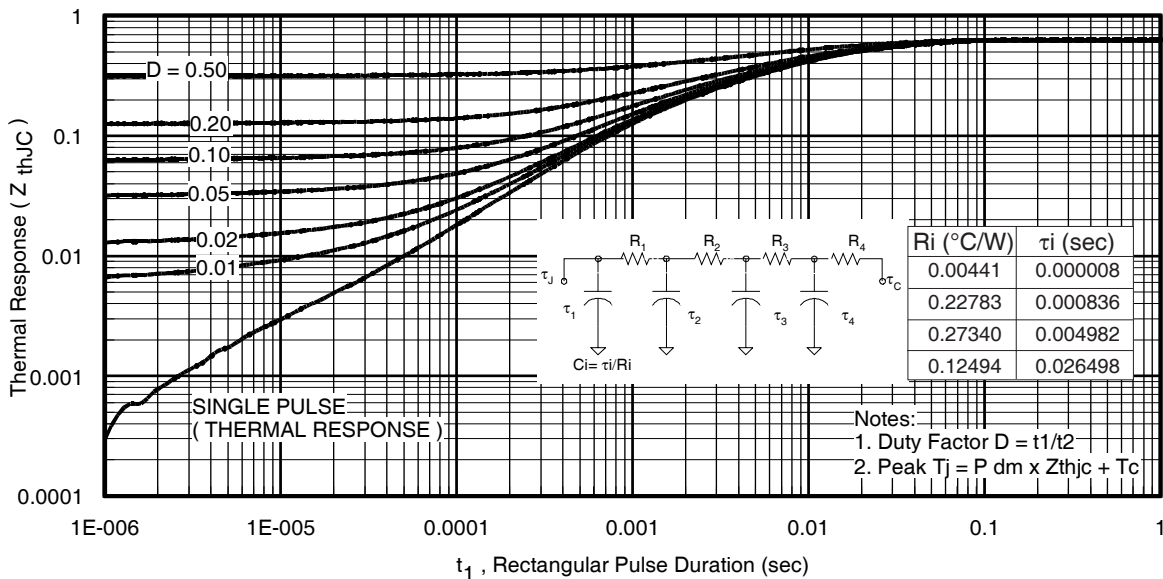
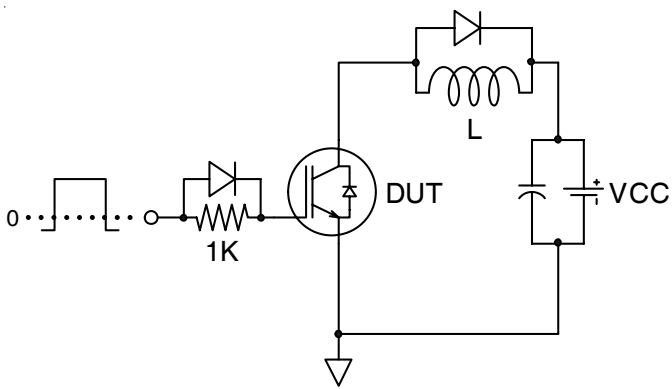
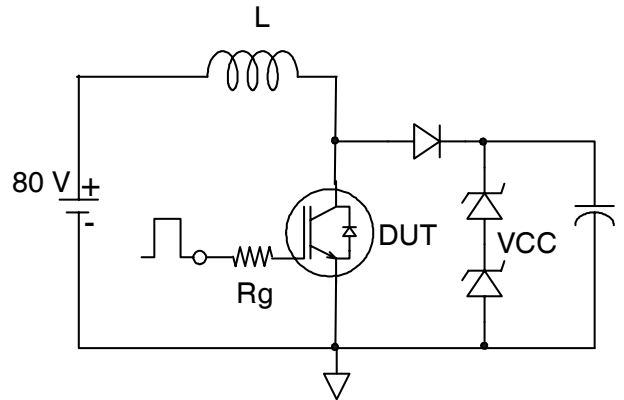
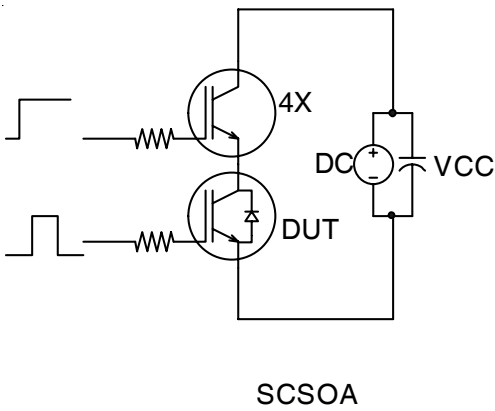
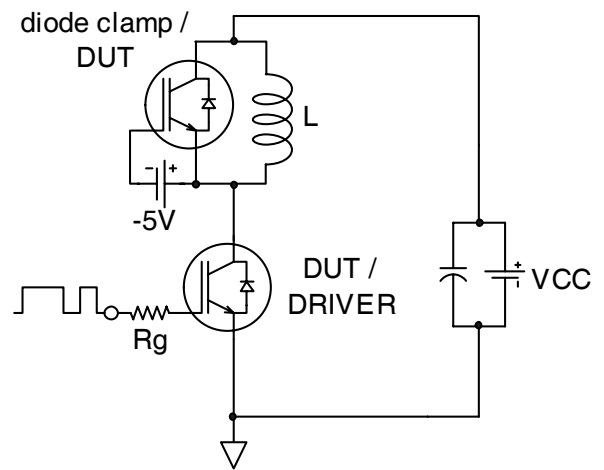
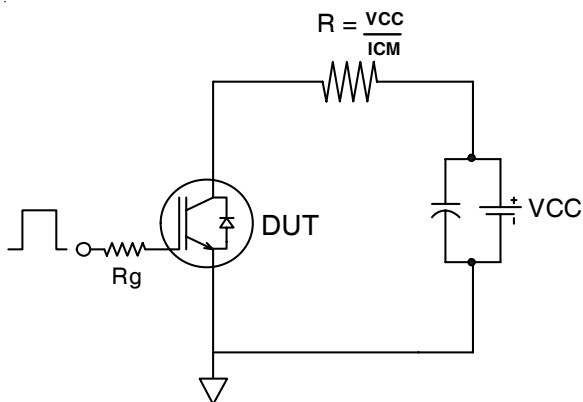
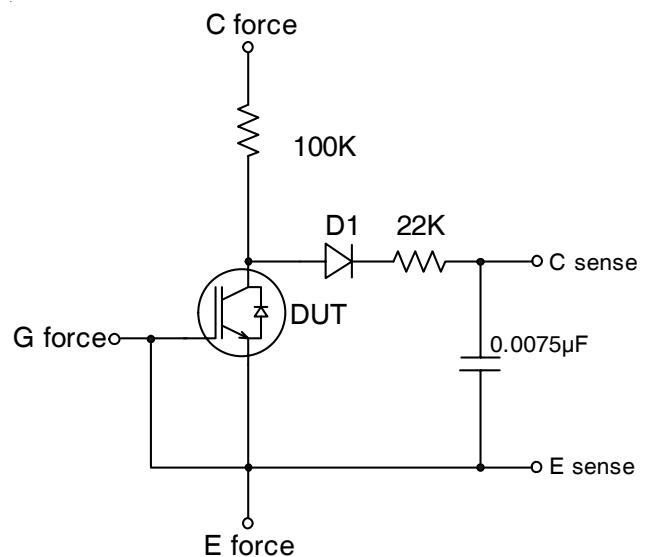

Fig. 27. Maximum Transient Thermal Impedance, Junction-to-Case (DIODE)

Fig.C.T.1 - Gate Charge Circuit (turn-off)

Fig.C.T.2 - RBSOA Circuit

Fig.C.T.3 - S.C. SOA Circuit

Fig.C.T.4 - Switching Loss Circuit

Fig.C.T.5 - Resistive Load Circuit

Fig.C.T.6 - BVCES Filter Circuit

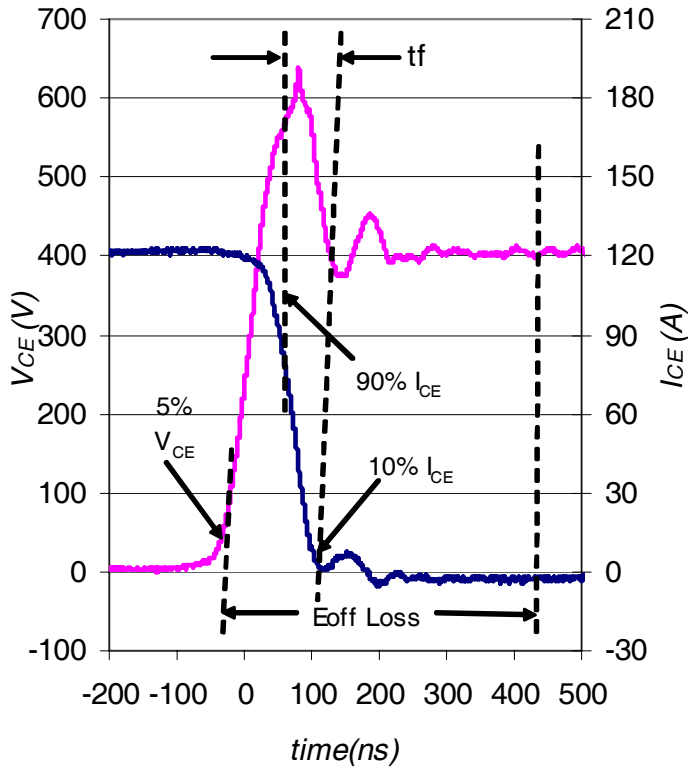

Fig. WF1 - Typ. Turn-off Loss Waveform
@ $T_J = 175^\circ\text{C}$ using Fig. CT.4

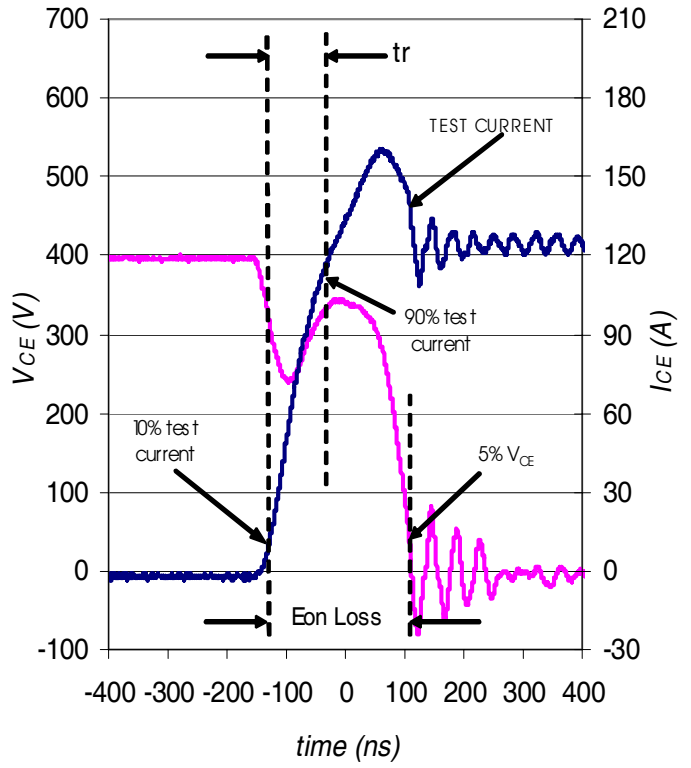

Fig. WF2 - Typ. Turn-on Loss Waveform
@ $T_J = 175^\circ\text{C}$ using Fig. CT.4

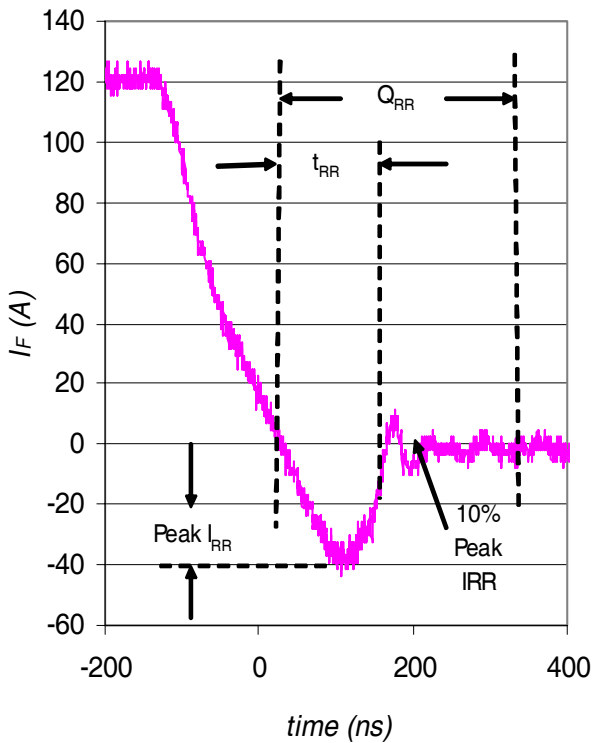

Fig. WF3 - Typ. Diode Recovery Waveform
@ $T_J = 175^\circ\text{C}$ using Fig. CT.4

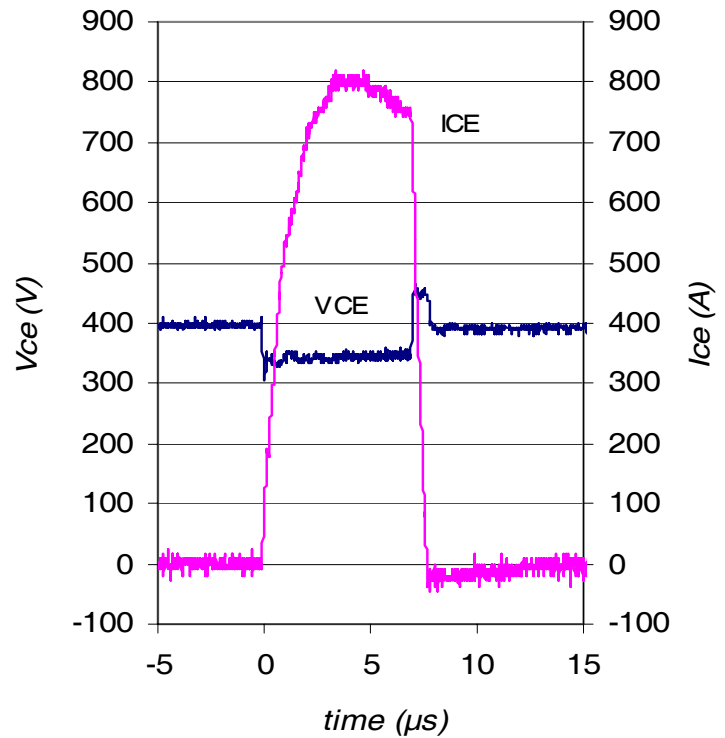
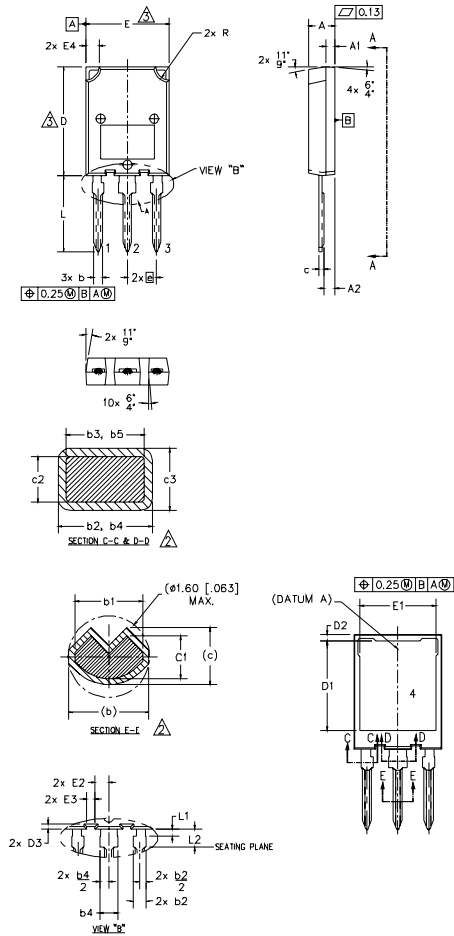

Fig. WF4 - Typ. S.C. Waveform
@ $T_J = 25^\circ\text{C}$ using Fig. CT.3

Case Outline and Dimensions — Super-247

NOTES:

1. DIMENSIONING AND TOLERANCING AS PER ASME Y14.5M-1994
2. DIMENSIONS b1, b3, b5, c1 & c3 APPLY TO BASE METAL ONLY.
3. DIMENSION D & E DO NOT INCLUDE MOLD FLASH. MOLD FLASH SHALL NOT EXCEED 0.127 [.005"] PER SIDE. THESE DIMENSIONS ARE MEASURED AT THE OUTER EXTREMES OF THE PLASTIC BODY.
- 4.- ALL DIMENSIONS SHOWN IN MILLIMETERS.
- 5.- CONTROLLING DIMENSION: MILLIMETER.
- 6.- OUTLINE CONFORMS TO JEDEC OUTLINE TO-274AA

SYM BO L	DIMENSIONS				NO TE S
	MILLIMETERS		INCHES		
	MIN.	MAX.	MIN.	MAX.	
A	4.50	5.50	.177	.217	
A1	1.45	2.15	.057	.085	
A2	1.65	2.35	.065	.093	
b	1.45	1.60	.054	.063	
b1	1.40	1.50	.055	.059	2
b2	2.00	2.40	.079	.094	
b3	1.95	2.35	.077	.093	2
b4	3.00	3.15	.118	.124	
b5	2.95	3.35	.116	.132	2
c	1.10	1.30	.043	.051	
c1	0.90	1.10	.035	.043	2
c2	0.65	0.85	.026	.033	
c3	0.50	0.70	.020	.028	2
D	19.80	20.80	.780	.819	3
D1	15.50	16.10	.610	.634	
D2	0.70	1.30	.028	.051	
D3	0.75	1.25	.030	.049	
E	15.10	16.10	.594	.634	3
E1	13.30	13.90	.524	.547	
E2	2.25	2.70	.089	.109	
E3	1.20	1.70	.047	.067	
E4	2.00	3.00	.079	.118	
e	5.45 BSC		.215 BSC		
L	13.80	14.80	.535	.583	
L1	1.00	1.60	.039	.063	
L2	3.85	4.25	.152	.167	
R	2.00	3.00	.079	.118	

LEAD ASSIGNMENTS
MOSFET

- 1.- GATE
- 2.- DRAIN
- 3.- SOURCE
- 4.- DRAIN

IGBT

- 1.- GATE
- 2.- COLLECTOR
- 3.- EMITTER
- 4.- COLLECTOR

Super-247 (TO-274AA) Part Marking Information

EXAMPLE: THIS IS AN IRFPS37N50A WITH
ASSEMBLY LOT CODE 1789
ASSEMBLED ON WW 19, 1997
IN THE ASSEMBLY LINE "C"

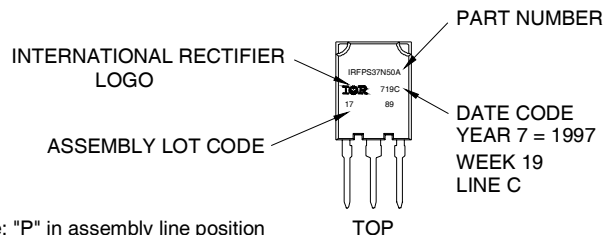

Note: "P" in assembly line position indicates "Lead-Free"

Note: For the most current drawing please refer to IR website at <http://www.irf.com/package/>