

The NTC Thermistors

This is a Negative Temperature Coefficient Resistor whose resistance changes as ambient temperature changes. Thermistor comprises 2 or 4 kinds of metal oxides of iron, nickel, cobalt, manganese and copper, being shaped and sintered at high temperature (1200 to 1500 °C)

■ Features

- Temperature Coefficient of Resistance is negative and extremely large
- Various kinds of types especially smaller ones are available.
- Resistance values are available from 22 Ω to 470 kΩ

■ Physical Characteristics of NTC Thermistors

Thermistor is a resistor sensitive to temperature utilizing the large temperature-coefficient of metal oxide semiconductor. And its temperature dependency of resistance value is indicated by the following equation:

$$R=R_0 \exp \left[B \left(\frac{1}{T} - \frac{1}{T_0} \right) \right] \dots\dots\dots (1)$$

- T₀: Standard Temperature 298.15 K(25 °C)
- R₀: Resistance at T₀ K
- B: Thermistor Constant (K)

So called Temperature Coefficient (α) is generally indicated as follows:

$$\alpha = - \frac{B}{T^2} \dots\dots\dots (2)$$

But α is not adequate for use as a constant, because a change by temperature is considerably large, so B Value is used as a coefficient of thermistor.

■ Major Characteristics of NTC Thermistors

The relation between resistance and temperature of a thermistor is linear as shown in Fig. 2, in which resistance is shown in vertical direction in a logarithmic scale and reciprocal of absolute temperature in horizontal direction. Bias degrees in these straight lines are determined according to the B Value expressed by the following equation.

$$B = \frac{\ln R_1 - \ln R_2}{\frac{1}{T_1} - \frac{1}{T_2}} \dots\dots\dots (3)$$

- R₁: Resistance at T₁ K
- R₂: Resistance at T₂ K

When calculated from this equation, B Value is a variable in a strict sense, and the resistance is expressed by the following equation:

$$R = AT^{-C} \exp D/T \dots\dots\dots (4)$$

In (4), C is a small positive or negative constant and quite negligible except use in precision temperature-measuring device, thereby the B Value is, in practical usage, to be considered as a constant. In Fig. 1, the relation between the resistance ratio R_T/R₂₅ (R₂₅: Resistance at 25 °C, R_T: Resistance at T °C) and B Value is shown with T °C, in the horizontal direction.

■ Recommended Applications

- For temperature measurement or temperature detection : thermometer, temperature controller
- For temperature compensation : transistor circuit, measuring instruments

Fig. 1

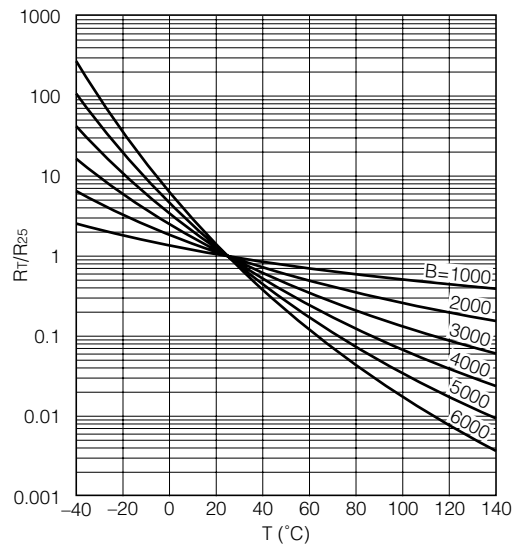
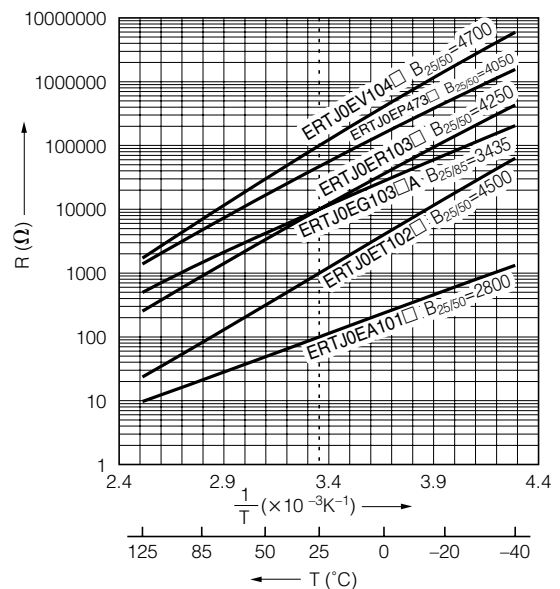
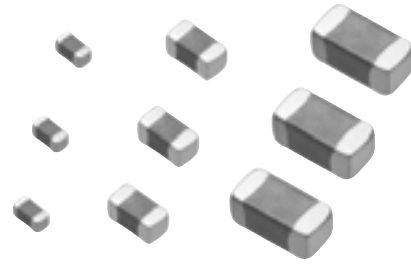

Fig. 2



Multilayer NTC Thermistors

Series: **ERTJ**



■ Features

- Surface Mount Device (0201, 0402, 0603)
- Highly reliable multilayer / monolithic structure
- Wide temperature operating range (-40 to 125 °C)
- Environmentally-friendly lead-free
- RoHS compliant

■ Recommended Applications

- Mobile Phone
 - Temperature compensation for crystal oscillator
 - Temperature compensation for semiconductor devices
- Personal Computer
 - Temperature detection for CPU and memory device
 - Temperature compensation for ink-viscosity (Inkjet Printer)
- Battery Pack
 - Temperature detection of battery cells
- Liquid Crystal Display
 - Temperature compensation of display contrast
 - Temperature compensation of display backlighting (CCFL)

■ Explanation of Part Numbers

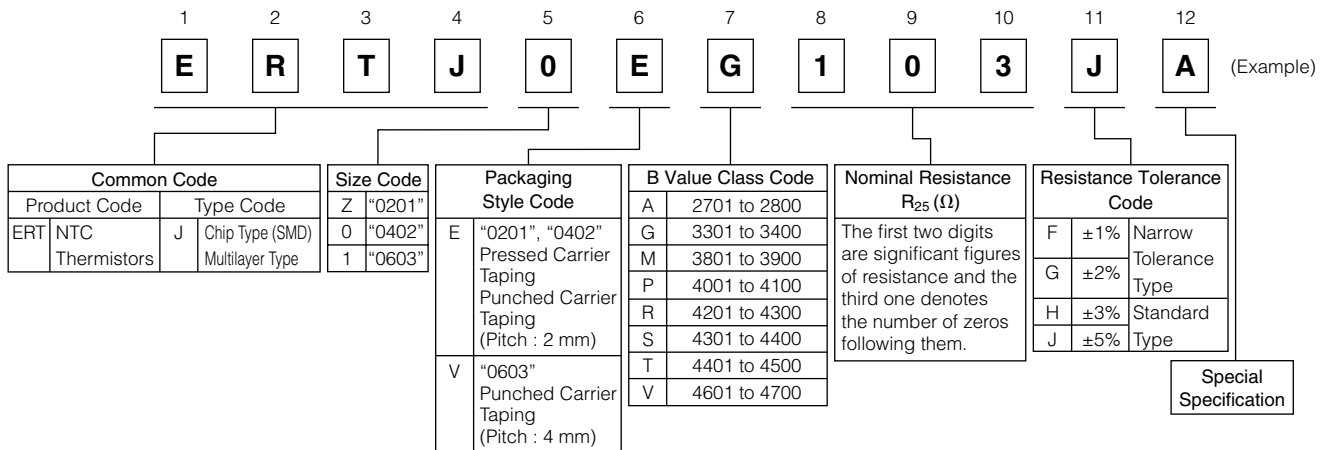

■ Construction

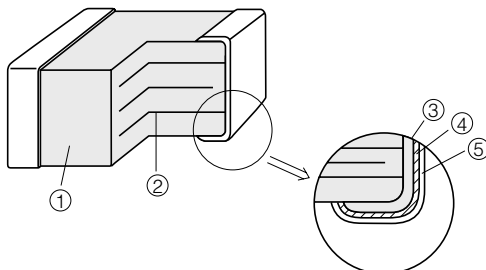

| No | Name | |
|----|-------------------------|------------------------|
| ① | Semiconductive Ceramics | |
| ② | Internal electrode | |
| ③ | Terminal electrode | Substrate electrode |
| ④ | | Intermediate electrode |
| ⑤ | | External electrode |

■ Dimensions in mm (not to scale)

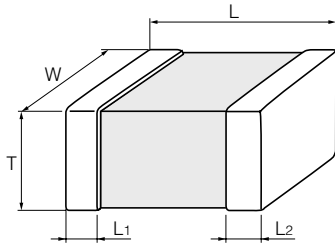

| Size Code (EIA) | L | W | T | L ₁ , L ₂ |
|-----------------|-----------|-----------|-----------|---------------------------------|
| Z(0201) | 0.60±0.03 | 0.30±0.03 | 0.30±0.03 | 0.15±0.05 |
| 0(0402) | 1.0±0.1 | 0.50±0.05 | 0.50±0.05 | 0.25±0.15 |
| 1(0603) | 1.60±0.15 | 0.8±0.1 | 0.8±0.1 | 0.3±0.2 |

(Unit : mm)

■ Packaging Methods

● Standard Packing Quantities

| Size Code | Thickness (mm) | Kind of Taping | Pitch (mm) | Quantity (pcs./reel) |
|-----------|----------------|------------------------|------------|----------------------|
| Z(0201) | 0.3 | Pressed Carrier Taping | 2 | 15,000 |
| 0(0402) | 0.5 | Punched Carrier Taping | 2 | 10,000 |
| 1(0603) | 0.8 | | 4 | 4,000 |

● Pitch 2 mm (Pressed Carrier Taping) : Size 0201

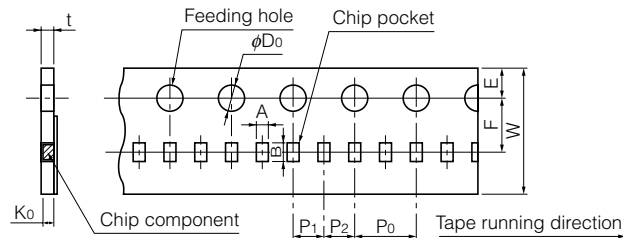

| Symbol | A | B | W | F | E | P ₁ | P ₂ | P ₀ | φD ₀ | t | K ₀ |
|-----------|---------------|---------------|-------------|---------------|---------------|----------------|----------------|----------------|-----------------|--------------|----------------|
| Dim. (mm) | 0.36 ±0.03 | 0.66 ±0.03 | 8.0 ±0.2 | 3.50 ±0.05 | 1.75 ±0.10 | 2.00 ±0.05 | 2.00 ±0.05 | 4.0 ±0.1 | 1.5+0.1 0 | 0.55 max. | 0.36 ±0.03 |

● Pitch 2 mm (Punched Carrier Taping) : Size 0402

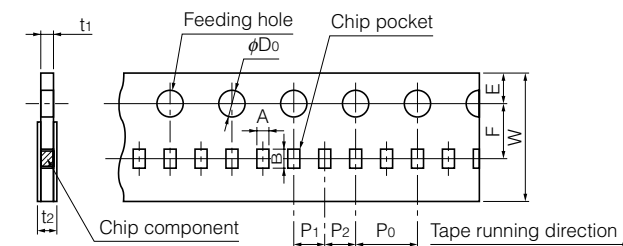

| Symbol | A | B | W | F | E | P ₁ | P ₂ | P ₀ | φD ₀ | t ₁ | t ₂ |
|-----------|---------------|---------------|-------------|---------------|---------------|----------------|----------------|----------------|-----------------|----------------|----------------|
| Dim. (mm) | 0.62 ±0.05 | 1.12 ±0.05 | 8.0 ±0.2 | 3.50 ±0.05 | 1.75 ±0.10 | 2.00 ±0.05 | 2.00 ±0.05 | 4.0 ±0.1 | 1.5+0.1 0 | 0.7 max. | 1.0 max. |

● Pitch 4 mm (Punched Carrier Taping) : Size 0603

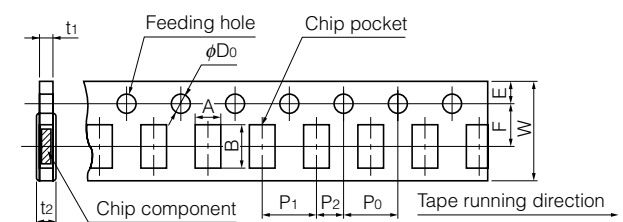

| Symbol | A | B | W | F | E | P ₁ | P ₂ | P ₀ | φD ₀ | t ₁ | t ₂ |
|-----------|-------------|-------------|-------------|---------------|---------------|----------------|----------------|----------------|-----------------|----------------|----------------|
| Dim. (mm) | 1.0 ±0.1 | 1.8 ±0.1 | 8.0 ±0.2 | 3.50 ±0.05 | 1.75 ±0.10 | 4.0 ±0.1 | 2.00 ±0.05 | 4.0 ±0.1 | 1.5+0.1 0 | 1.1 max. | 1.4 max. |

● Reel for Taping

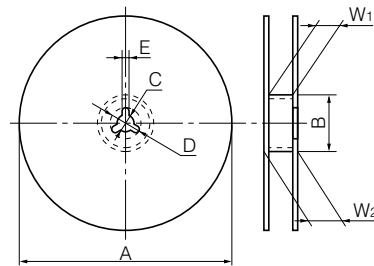

| Symbol | φA | φB | C | D | E | W ₁ | W ₂ |
|-----------|--------------------------------|-----------------------------------|----------|----------|---------|----------------------------------|----------------|
| Dim. (mm) | 180 ⁰ ₋₃ | 60.0 ^{+1.0} ₀ | 13.0±0.5 | 21.0±0.8 | 2.0±0.5 | 9.0 ^{+1.0} ₀ | 11.4±1.0 |

● Leader Part and Taped End

Leader part

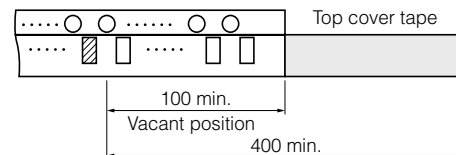

Taped end

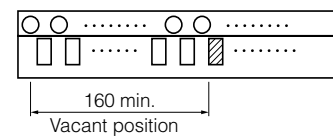

(Unit : mm)

■ Minimum Quantity / Packing Unit

| Part Number (Size) | Minimum Quantity / Packing Unit | Packing Quantity in Carton | Carton L×W×H (mm) |
|--------------------|---------------------------------|----------------------------|-------------------|
| ERTJZ (0201) | 15,000 | 300,000 | 250×200×200 |
| ERTJ0 (0402) | 10,000 | 200,000 | 250×200×200 |
| ERTJ1 (0603) | 4,000 | 80,000 | 250×200×200 |

Part No., quantity and country of origin are designated on outer packages in English.

■ Ratings

| Size code (EIA) | Z(0201) | 0(0402) | 1(0603) |
|-----------------------------------|-----------------------|-----------------------|-----------------------|
| Operating Temperature Range | -40 to 125 °C | | |
| Rated Maximum Power Dissipation*1 | 33 mW | 66 mW | 100 mW |
| Dissipation Factor*2 | approximately 1 mW/°C | approximately 2 mW/°C | approximately 3 mW/°C |

*1 Rated Maximum Power Dissipation : The maximum power that can be continuously applied at the rated ambient temperature.
 · The Maximum Power Dissipation under ambient temperature 25 °C or less is the same with the rated maximum power dissipation, and Maximum power dissipation beyond 25 °C depends on the Decreased power dissipation curve.
 · Please see "Operating Power" for details paging 371.

*2 Dissipation factor : The constant amount power required to raise the temperature of the Thermistor 1 °C through self heat generation under stable temperatures.
 · Dissipation factor is the reference value when mounted on a glass epoxy board (1.6 mmT).

● Resistance ratios to R₂₅ at each temperature/Reference values

(for obtaining resistance at each temperature by using R₂₅ shown in part number)

| | ERTJ□□□A~ | | ERTJ□□G~ | ERTJ□□M~ | ERTJ□□P~ | ERTJ□□R~ | ERTJ0ES~ | ERTJ1VS~ | ERTJ□□T~ | ERTJ0ET104□ | ERTJ□□V~ |
|--------------------|-----------|----------|----------|----------|----------|----------|----------|----------|----------|-------------|----------|
| B _{25/50} | 2750 K | 2800 K | (3375 K) | 3900 K | 4050 K | 4250K | 4330K | (4330K) | 4500K | 4500K | 4700K |
| B _{25/85} | (2700 K) | (2750 K) | 3435 K | (3970 K) | (4100 K) | (4300K) | (4390K) | 4390K | (4450K) | (4580K) | (4750K) |
| T(°C) | | | | | | | | | *1 | *2 | |
| -40 | 13.05 | 13.28 | 20.52 | 32.11 | 33.10 | 43.10 | 45.67 | 45.53 | 63.30 | 47.07 | 59.76 |
| -35 | 10.21 | 10.40 | 15.48 | 23.29 | 24.03 | 30.45 | 32.08 | 31.99 | 42.92 | 33.31 | 41.10 |
| -30 | 8.061 | 8.214 | 11.79 | 17.08 | 17.63 | 21.76 | 22.80 | 22.74 | 29.50 | 23.80 | 28.61 |
| -25 | 6.427 | 6.547 | 9.069 | 12.65 | 13.06 | 15.73 | 16.39 | 16.35 | 20.53 | 17.16 | 20.14 |
| -20 | 5.168 | 5.261 | 7.037 | 9.465 | 9.761 | 11.48 | 11.91 | 11.89 | 14.46 | 12.49 | 14.33 |
| -15 | 4.191 | 4.261 | 5.507 | 7.147 | 7.362 | 8.466 | 8.743 | 8.727 | 10.30 | 9.159 | 10.31 |
| -10 | 3.424 | 3.476 | 4.344 | 5.444 | 5.599 | 6.300 | 6.479 | 6.469 | 7.407 | 6.772 | 7.482 |
| -5 | 2.819 | 2.856 | 3.453 | 4.181 | 4.291 | 4.730 | 4.845 | 4.839 | 5.388 | 5.046 | 5.481 |
| 0 | 2.336 | 2.362 | 2.764 | 3.237 | 3.312 | 3.582 | 3.654 | 3.650 | 3.966 | 3.789 | 4.050 |
| 5 | 1.948 | 1.966 | 2.227 | 2.524 | 2.574 | 2.734 | 2.778 | 2.776 | 2.953 | 2.864 | 3.015 |
| 10 | 1.635 | 1.646 | 1.806 | 1.981 | 2.013 | 2.102 | 2.128 | 2.126 | 2.221 | 2.179 | 2.262 |
| 15 | 1.380 | 1.386 | 1.474 | 1.567 | 1.584 | 1.629 | 1.642 | 1.641 | 1.687 | 1.669 | 1.710 |
| 20 | 1.171 | 1.174 | 1.211 | 1.247 | 1.255 | 1.272 | 1.277 | 1.276 | 1.293 | 1.287 | 1.303 |
| 25 | 1 | 1 | 1 | 1 | 1 | 1 | 1 | 1 | 1 | 1 | 1 |
| 30 | 0.8585 | 0.8565 | 0.8309 | 0.8072 | 0.8016 | 0.7921 | 0.7888 | 0.7890 | 0.7799 | 0.7823 | 0.7734 |
| 35 | 0.7407 | 0.7372 | 0.6941 | 0.6556 | 0.6461 | 0.6315 | 0.6263 | 0.6266 | 0.6131 | 0.6158 | 0.6023 |
| 40 | 0.6422 | 0.6376 | 0.5828 | 0.5356 | 0.5235 | 0.5067 | 0.5004 | 0.5007 | 0.4856 | 0.4876 | 0.4721 |
| 45 | 0.5595 | 0.5541 | 0.4916 | 0.4401 | 0.4266 | 0.4090 | 0.4022 | 0.4025 | 0.3874 | 0.3884 | 0.3723 |
| 50 | 0.4899 | 0.4836 | 0.4165 | 0.3635 | 0.3496 | 0.3319 | 0.3251 | 0.3254 | 0.3111 | 0.3111 | 0.2954 |
| 55 | 0.4309 | 0.4238 | 0.3543 | 0.3018 | 0.2881 | 0.2709 | 0.2642 | 0.2645 | 0.2513 | 0.2504 | 0.2356 |
| 60 | 0.3806 | 0.3730 | 0.3027 | 0.2518 | 0.2386 | 0.2222 | 0.2158 | 0.2161 | 0.2042 | 0.2026 | 0.1889 |
| 65 | 0.3376 | 0.3295 | 0.2595 | 0.2111 | 0.1985 | 0.1832 | 0.1772 | 0.1774 | 0.1670 | 0.1648 | 0.1523 |
| 70 | 0.3008 | 0.2922 | 0.2233 | 0.1777 | 0.1659 | 0.1518 | 0.1463 | 0.1465 | 0.1377 | 0.1348 | 0.1236 |
| 75 | 0.2691 | 0.2600 | 0.1929 | 0.1504 | 0.1393 | 0.1264 | 0.1213 | 0.1215 | 0.1144 | 0.1108 | 0.1009 |
| 80 | 0.2417 | 0.2322 | 0.1672 | 0.1278 | 0.1174 | 0.1057 | 0.1011 | 0.1013 | 0.09560 | 0.09162 | 0.08284 |
| 85 | 0.2180 | 0.2081 | 0.1451 | 0.1090 | 0.09937 | 0.08873 | 0.08469 | 0.08486 | 0.08033 | 0.07609 | 0.06834 |
| 90 | 0.1974 | 0.1871 | 0.1261 | 0.09310 | 0.08442 | 0.07468 | 0.07122 | 0.07138 | 0.06782 | 0.06345 | 0.05662 |
| 95 | 0.1793 | 0.1688 | 0.1097 | 0.07980 | 0.07200 | 0.06307 | 0.06014 | 0.06028 | 0.05753 | 0.05314 | 0.04712 |
| 100 | 0.1636 | 0.1528 | 0.09563 | 0.06871 | 0.06166 | 0.05353 | 0.05099 | 0.05112 | 0.04903 | 0.04472 | 0.03939 |
| 105 | 0.1498 | 0.1387 | 0.08357 | 0.05947 | 0.05306 | 0.04568 | 0.04340 | 0.04351 | 0.04198 | 0.03784 | 0.03308 |
| 110 | 0.1377 | 0.1263 | 0.07317 | 0.05170 | 0.04587 | 0.03918 | 0.03708 | 0.03718 | 0.03609 | 0.03218 | 0.02791 |
| 115 | 0.1270 | 0.1153 | 0.06421 | 0.04512 | 0.03979 | 0.03374 | 0.03179 | 0.03188 | 0.03117 | 0.02748 | 0.02364 |
| 120 | 0.1175 | 0.1056 | 0.05650 | 0.03951 | 0.03460 | 0.02916 | 0.02734 | 0.02742 | 0.02702 | 0.02352 | 0.02009 |
| 125 | 0.1091 | 0.09695 | 0.04986 | 0.03470 | 0.03013 | 0.02527 | 0.02359 | 0.02367 | 0.02351 | 0.02017 | 0.01712 |

*1 Other than ERTJ0ET104□ in B_{25/50}=4500K.

*2 ERTJ0ET104□ only.

$$B_{25/50} = \frac{\ln(R_{25}/R_{50})}{1/298.15 - 1/323.15}$$

$$B_{25/85} = \frac{\ln(R_{25}/R_{85})}{1/298.15 - 1/358.15}$$

R₂₅=Resistance at 25.0±0.1 °C
 R₅₀=Resistance at 50.0±0.1 °C
 R₈₅=Resistance at 85.0±0.1 °C

Design and specifications are each subject to change without notice. Ask factory for the current technical specifications before purchase and/or use.
 Should a safety concern arise regarding this product, please be sure to contact us immediately.

■ Specification and Test Method

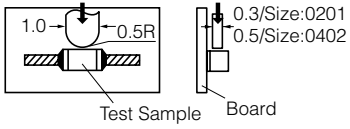
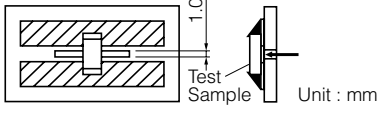
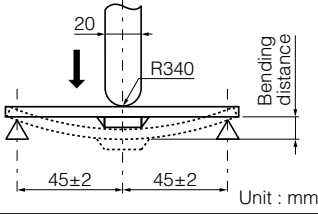
| Item | Specification | Test Method | | | | | | | | | | | | | | | | | | |
|--|---|---|------------------|----------------|------------------------|--------------------|--------------|----------------|--------------------|--------------|---|------|-----------|------------|---|-----------|------------|---|------------|------------|
| Rated Zero-power Resistance (R ₂₅) | Within the specified tolerance. | The value of the d.c. resistance shall be measured at the rated ambient temperature of 25.0 ±0.1 °C under the power less than 0.1mW which is negligible self heat generation. | | | | | | | | | | | | | | | | | | |
| B Value | Within the specified tolerance. * Individual Specification shall specify B _{25/50} or B _{25/85} . | The Zero-power resistances; R ₁ and R ₂ , shall be measured respectively at T ₁ (°C) and T ₂ (°C). The B value is calculated by the following equation. $B_{T_1/T_2} = \frac{\ln(R_1) - \ln(R_2)}{1/(T_1 + 273.15) - 1/(T_2 + 273.15)}$ <table border="1"> <thead> <tr> <th></th> <th>T₁</th> <th>T₂</th> </tr> </thead> <tbody> <tr> <td>B_{25/50}</td> <td>25.0 ±0.1 °C</td> <td>50.0 ±0.1 °C</td> </tr> <tr> <td>B_{25/85}</td> <td>25.0 ±0.1 °C</td> <td>85.0 ±0.1 °C</td> </tr> </tbody> </table> | | T ₁ | T ₂ | B _{25/50} | 25.0 ±0.1 °C | 50.0 ±0.1 °C | B _{25/85} | 25.0 ±0.1 °C | 85.0 ±0.1 °C | | | | | | | | | |
| | T ₁ | T ₂ | | | | | | | | | | | | | | | | | | |
| B _{25/50} | 25.0 ±0.1 °C | 50.0 ±0.1 °C | | | | | | | | | | | | | | | | | | |
| B _{25/85} | 25.0 ±0.1 °C | 85.0 ±0.1 °C | | | | | | | | | | | | | | | | | | |
| Adhesion | The terminal electrode shall be free from peeling or signs of peeling. | Applied force : Size 0201 : 2 N Size 0402, 0603 : 5 N Duration : 10 s Size : 0201, 0402  Size : 0603  Unit : mm | | | | | | | | | | | | | | | | | | |
| Bending Strength | There shall be no cracks and other mechanical damage. R ₂₅ change : within ±5 % | Bending distance : 1 mm Bending speed : 1 mm/s  Unit : mm | | | | | | | | | | | | | | | | | | |
| Resistance to Soldering Heat | There shall be no cracks and other mechanical damage. <table border="1"> <thead> <tr> <th></th> <th>Narrow Tol. type</th> <th>Standard type</th> </tr> </thead> <tbody> <tr> <td>R₂₅ change</td> <td>: within ±2 %</td> <td>within ±3 %</td> </tr> <tr> <td>B Value change</td> <td>: within ±1 %</td> <td>within ±2 %</td> </tr> </tbody> </table> | | Narrow Tol. type | Standard type | R ₂₅ change | : within ±2 % | within ±3 % | B Value change | : within ±1 % | within ±2 % | Soldering bath method Solder temperature : 270 ±5 °C Dipping period : 3.0 ±0.5 s Preheat condition : <table border="1"> <thead> <tr> <th>Step</th> <th>Temp (°C)</th> <th>Period (s)</th> </tr> </thead> <tbody> <tr> <td>1</td> <td>80 to 100</td> <td>120 to 180</td> </tr> <tr> <td>2</td> <td>150 to 200</td> <td>120 to 180</td> </tr> </tbody> </table> | Step | Temp (°C) | Period (s) | 1 | 80 to 100 | 120 to 180 | 2 | 150 to 200 | 120 to 180 |
| | Narrow Tol. type | Standard type | | | | | | | | | | | | | | | | | | |
| R ₂₅ change | : within ±2 % | within ±3 % | | | | | | | | | | | | | | | | | | |
| B Value change | : within ±1 % | within ±2 % | | | | | | | | | | | | | | | | | | |
| Step | Temp (°C) | Period (s) | | | | | | | | | | | | | | | | | | |
| 1 | 80 to 100 | 120 to 180 | | | | | | | | | | | | | | | | | | |
| 2 | 150 to 200 | 120 to 180 | | | | | | | | | | | | | | | | | | |
| Solderability | More than 75 % of the soldered area of both terminal electrodes shall be covered with fresh solder. | Soldering bath method Solder temperature : 230 ±5 °C Dipping period : 4 ±1 s Solder : H63A (JIS-Z-3282) | | | | | | | | | | | | | | | | | | |

■ Specification and Test Method

| Item | Specification | | Test Method |
|---------------------|--|---|--|
| Temperature Cycling | Narrow Tol. type R ₂₅ change : within ±2 % B Value change : within ±1 % | Standard type within ±3 % within ±2 % | Conditions of one cycle Step 1 : -40 °C, 30±3 min Step 2 : Room temp., 3 min max. Step 3 : 125 °C, 30±3 min. Step 4 : Room temp., 3 min max. Number of cycles: 100 cycles |
| Moisture Resistance | Narrow Tol. type R ₂₅ change : within ±2 % B Value change : within ±1 % | Standard type within ±3 % within ±2 % | Temperature : 85 ±2 °C Relative humidity : 85 ±5 % Test period : 1000 +48/0 h |
| Damp Heat Load | Narrow Tol. type R ₂₅ change : within ±2 % B Value change : within ±1 % | Standard type within ±3 % within ±2 % | Temperature : 85 ±2 °C Relative humidity : 85 ±5 % Applied power : 10 mW Test period : 500 +24/0 h |
| Cold Resistance | Narrow Tol. type R ₂₅ change : within ±2 % B Value change : within ±1 % | Standard type within ±3 % within ±2 % | Temperature : -40 ±3 °C Test period : 1000 +48/0 h |
| Dry Heat Resistance | Narrow Tol. type R ₂₅ change : within ±2 % B Value change : within ±1 % | Standard type within ±3 % within ±2 % | Temperature : 125 ±3 °C Test period : 1000 +48/0 h |

■ Part Number List of Narrow Tolerance Type (Resistance Tolerance : ±2 %, ±1 %)

● 0201(EIA)

| Nominal Resistance at 25 °C | Resistance Tolerance | B value class code | | G | P | V |
|-----------------------------|----------------------------|---|--|------------------------|------------------------|------------------------|
| | | Nominal B value *() Reference value | B _{25/50} B _{25/85} | (3375 K) 3435 K±1 % | 4050 K±1 % (4100 K) | 4700 K±1 % (4750 K) |
| 10 kΩ | ±1 % (F) or ±2 % (G) | | | ERTJZEG103□A | | |
| 47 kΩ | | | | | ERTJZEP473□ | |
| 100 kΩ | | | | | | ERTJZEV104□ |

□ : Resistance Tolerance Code
Avoid flow soldering.

● 0402(EIA)

| Nominal Resistance at 25 °C | Resistance Tolerance | B value class code | | G | P | S | V |
|-----------------------------|----------------------------|---|--|------------------------|------------------------|------------------------|------------------------|
| | | Nominal B value *() Reference value | B _{25/50} B _{25/85} | (3375 K) 3435 K±1 % | 4050 K±1 % (4100 K) | 4330 K±1 % (4390 K) | 4700 K±1 % (4750 K) |
| 10 kΩ | ±1 % (F) or ±2 % (G) | | | ERTJ0EG103□A | | | |
| 47 kΩ | | | | | ERTJ0EP473□ | | |
| 100 kΩ | | | | | | ERTJ0ES104□ | ERTJ0EV104□ |

□ : Resistance Tolerance Code
Avoid flow soldering.

● 0603(EIA)

| Nominal Resistance at 25 °C | Resistance Tolerance | B value class code | | G | S |
|-----------------------------|----------------------------|---|--|------------------------|------------------------|
| | | Nominal B value *() Reference value | B _{25/50} B _{25/85} | (3375 K) 3435 K±1 % | (4330 K) 4390 K±1 % |
| 10 kΩ | ±1 % (F) or ±2 % (G) | | | ERTJ1VG103□A | |
| 100 kΩ | | | | | ERTJ1VS104□A |

□ : Resistance Tolerance Code
Avoid flow soldering.

■ Part Number List of Standard Type (Resistance Tolerance : $\pm 5\%$, $\pm 3\%$)

● 0201(EIA)

| Nominal Resistance at 25 °C | Resistance Tolerance | B value class code | | G | P | T | V |
|-----------------------------|--------------------------------------|---|--|------------------------------|------------------------------|------------------------------|------------------------------|
| | | Nominal B value *() Reference value | B _{25/50} B _{25/85} | (3375 K) 3435 K $\pm 2\%$ | 4050 K $\pm 3\%$ (4100 K) | 4500 K $\pm 2\%$ (4450 K) | 4700 K $\pm 2\%$ (4750 K) |
| 2.0 k Ω | $\pm 3\%$ (H) or $\pm 5\%$ (J) | | | | | ERTJZET202□ | |
| 3.0 k Ω | | | | | | ERTJZET302□ | |
| 4.7 k Ω | | | | | | ERTJZET472□ | |
| 10 k Ω | | | | | ERTJZEG103□A | | |
| 47 k Ω | | | | | | ERTJZEP473□ | |
| 100 k Ω | | | | | | | ERTJZEV104□ |

□ : Resistance Tolerance Code
Avoid flow soldering.

● 0402(EIA)

| Nominal Resistance at 25 °C | Resistance Tolerance | B value class code | | A | |
|-----------------------------|--------------------------------------|---|--|------------------------------|------------------------------|
| | | Nominal B value *() Reference value | B _{25/50} B _{25/85} | 2750 K $\pm 3\%$ (2700 K) | 2800 K $\pm 3\%$ (2750 K) |
| 22 Ω | $\pm 3\%$ (H) or $\pm 5\%$ (J) | | | ERTJ0EA220□ | |
| 33 Ω | | | | ERTJ0EA330□ | |
| 40 Ω | | | | ERTJ0EA400□ | |
| 47 Ω | | | | ERTJ0EA470□ | |
| 68 Ω | | | | | ERTJ0EA680□ |
| 100 Ω | | | | | ERTJ0EA101□ |
| 150 Ω | | | | | ERTJ0EA151□ |

| Nominal Resistance at 25 °C | Resistance Tolerance | B value class code | | G | M | P | R | |
|-----------------------------|--------------------------------------|---|--|------------------------------|------------------------------|------------------------------|------------------------------|-------------|
| | | Nominal B value *() Reference value | B _{25/50} B _{25/85} | (3375 K) 3435 K $\pm 1\%$ | 3900 K $\pm 2\%$ (3970 K) | 4050 K $\pm 2\%$ (4100 K) | 4250 K $\pm 2\%$ (4300 K) | |
| 3.3 k Ω | $\pm 3\%$ (H) or $\pm 5\%$ (J) | | | | | | ERTJ0ER332□ | |
| 4.7 k Ω | | | | | | | ERTJ0ER472□ | |
| 6.8 k Ω | | | | | | | ERTJ0ER682□ | |
| 10 k Ω | | | | | ERTJ0EG103□A | ERTJ0EM103□ | | ERTJ0ER103□ |
| 15 k Ω | | | | | | | | ERTJ0ER153□ |
| 22 k Ω | | | | | | | | ERTJ0ER223□ |
| 33 k Ω | | | | | | | ERTJ0EP333□ | ERTJ0ER333□ |
| 47 k Ω | | | | | | | ERTJ0EP473□ | |
| 100 k Ω | | | | | | | ERTJ0EP104□ | |

| Nominal Resistance at 25 °C | Resistance Tolerance | B value class code | | S | T | V | |
|-----------------------------|--------------------------------------|---|--|------------------------------|--------------------------------------|------------------------------|-------------|
| | | Nominal B value *() Reference value | B _{25/50} B _{25/85} | 4330 K $\pm 2\%$ (4390 K) | 4500 K $\pm 2\%$ (4450 K, 4580 K) | 4700 K $\pm 2\%$ (4750 K) | |
| 1.0 k Ω | $\pm 3\%$ (H) or $\pm 5\%$ (J) | | | | ERTJ0ET102□ | | |
| 1.5 k Ω | | | | | ERTJ0ET152□ | | |
| 2.0 k Ω | | | | | ERTJ0ET202□ | | |
| 2.2 k Ω | | | | | ERTJ0ET222□ | | |
| 3.0 k Ω | | | | | ERTJ0ET302□ | | |
| 3.3 k Ω | | | | | ERTJ0ET332□ | | |
| 4.7 k Ω | | | | | ERTJ0ET472□ | | |
| 47 k Ω | | | | | | ERTJ0EV473□ | |
| 68 k Ω | | | | | | ERTJ0EV683□ | |
| 100 k Ω | | | | | ERTJ0ES104□ | ERTJ0ET104□ | ERTJ0EV104□ |
| 150 k Ω | | | | | | ERTJ0ET154□ | ERTJ0EV154□ |
| 220 k Ω | | | | | | | ERTJ0EV224□ |
| 330 k Ω | | | | | | | ERTJ0EV334□ |
| 470 k Ω | | | | | | | ERTJ0EV474□ |

□ : Resistance Tolerance Code
Avoid flow soldering.

● 0603(EIA)

| Nominal Resistance at 25 °C | Resistance Tolerance | B value class code | | A | | G | P |
|-----------------------------|----------------------------|---|--|------------------------|------------------------|------------------------|------------------------|
| | | Nominal B value *() Reference value | B _{25/50} B _{25/85} | 2750 K±3 % (2700 K) | 2800 K±3 % (2750 K) | (3375 K) 3435 K±1 % | 4050 K±3 % (4100 K) |
| 22 Ω | ±3 % (H) or ±5 % (J) | | | ERTJ1VA220□ | | | |
| 33 Ω | | | | ERTJ1VA330□ | | | |
| 40 Ω | | | | | ERTJ1VA400□ | | |
| 47 Ω | | | | | ERTJ1VA470□ | | |
| 68 Ω | | | | | ERTJ1VA680□ | | |
| 100 Ω | | | | | ERTJ1VA101□ | | |
| 10 kΩ | | | | | | ERTJ1VG103□A | |
| 47 kΩ | | | | | | | ERTJ1VP473□ |

| Nominal Resistance at 25 °C | Resistance Tolerance | B value class code | | R | S | T | V |
|-----------------------------|----------------------------|---|--|------------------------|-----------------------|------------------------|------------------------|
| | | Nominal B value *() Reference value | B _{25/50} B _{25/85} | 4250 K±2 % (4300 K) | (4330 K) 4390 K±1% | 4500 K±2 % (4450 K) | 4700 K±2 % (4750 K) |
| 1.0 kΩ | ±3 % (H) or ±5 % (J) | | | | | ERTJ1VT102□ | |
| 1.5 kΩ | | | | | | ERTJ1VT152□ | |
| 2.0 kΩ | | | | | | ERTJ1VT202□ | |
| 2.2 kΩ | | | | | | ERTJ1VT222□ | |
| 3.0 kΩ | | | | | | ERTJ1VT302□ | |
| 3.3 kΩ | | | | | ERTJ1VR332□ | | ERTJ1VT332□ |
| 4.7 kΩ | | | | | ERTJ1VR472□ | | ERTJ1VT472□ |
| 6.8 kΩ | | | | | ERTJ1VR682□ | | |
| 10 kΩ | | | | | ERTJ1VR103□ | | |
| 15 kΩ | | | | | ERTJ1VR153□ | | |
| 22 kΩ | | | | | ERTJ1VR223□ | | |
| 33 kΩ | | | | | ERTJ1VR333□ | | |
| 47 kΩ | | | | | ERTJ1VR473□ | | ERTJ1VV473□ |
| 68 kΩ | | | | | ERTJ1VR683□ | | ERTJ1VV683□ |
| 100 kΩ | | | | | | ERTJ1VS104□A | ERTJ1VV104□ |
| 150 kΩ | | | | | | | ERTJ1VV154□ |

□ : Resistance Tolerance Code
Avoid flow soldering.

- Typical Application
- Temperature Detection

Writing current control of HDD

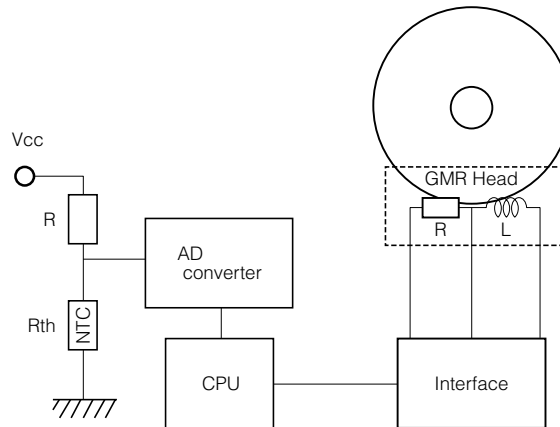

- Temperature Compensation (Pseudo-linearization)

Contrast level control of LCD

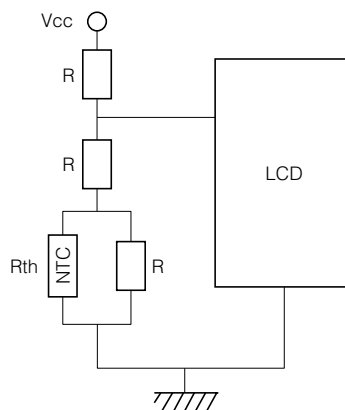

- Temperature Compensation (RF circuit)

Temperature compensation of TCXO

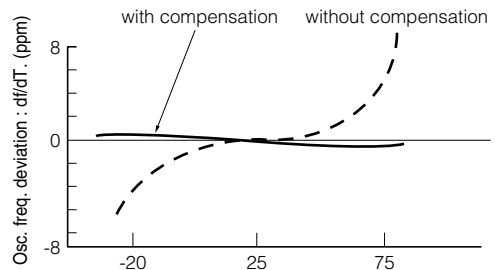
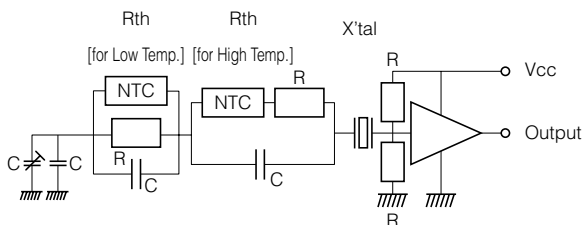

Multilayer Chip NTC Thermistors

Series: **ERTJ**

Handling Precautions

⚠ Safety Precautions

Multilayer NTC Thermistors (hereafter referred to as “Thermistors”) should be used for general purpose applications found in consumer electronics (audio/visual, home, office, information & communication) equipment. When subjected to severe electrical, environmental, and/or mechanical stress beyond the specifications, as noted in the Ratings and Specified Conditions section, the Thermistor may fail in a short circuit mode or in an open-circuit mode. This case results in a burn-out, smoke or flaming.

For products which require high safety levels, please carefully consider how a single malfunction can affect your product. In order to ensure the safety in the case of a single malfunction, please design products with fail-safe, such as setting up protecting circuits, etc.

- For the following applications and conditions, please contact us for additional not found in this document.
 - When your application may have difficulty complying with the safety or handling precautions specified below.
 - For any applications where a malfunction with this product may directly or indirectly cause hazardous conditions which could result in death or injury;
 - ① Aircraft and Aerospace Equipment (artificial satellite, rocket, etc.)
 - ② Submarine Equipment (submarine repeating equipment, etc.)
 - ③ Transportation Equipment (motor vehicles, airplanes, trains, ship, traffic signal controllers, etc.)
 - ④ Power Generation Control Equipment (atomic power, hydroelectric power, thermal power plant control system, etc.)
 - ⑤ Medical Equipment (life-support equipment, pacemakers, dialysis controllers, etc.)
 - ⑥ Information Processing Equipment (large scale computer systems, etc.)
 - ⑦ Electric Heating Appliances, Combustion devices (gas fan heaters, oil fan heaters, etc.)
 - ⑧ Rotary Motion Equipment
 - ⑨ Security Systems
 - ⑩ And any similar types of equipment

■ Operating Conditions and Circuit Design
1. Circuit Design

1.1 Operating Temperature and Storage Temperature

The specified “Operating Temperature Range” found in the Specifications is the absolute maximum and minimum temperature rating. Every Thermistor shall be operated within the specified “Operating Temperature Range”.

The Thermistors mounted on PCB shall be stored without operating within the specified “Storage Temperature Range” in the Specifications.

1.2 Operating Power

Thermistors shall not be operated in excess of the “Maximum power dissipation”.

If the Thermistors are operated beyond the specified Maximum power dissipation, it may cause burnout and/or damage due to thermal run away.

For temperature detection applications, the accuracy may be greatly influenced by self-heat generation and the heat dissipation of the Thermistor, even if the Thermistor is operated under the specified Maximum Power Dissipation.

Please check the safety and reliability of your circuit.

[Maximum power dissipation]

·The Maximum power that can be continuously applied under static air at a certain ambient temperature. The Maximum power dissipation under an ambient temperature of 25 °C or less is the same with the rated maximum power dissipation, and Maximum power dissipation beyond 25 °C depends on the Decreased power dissipation curve below.

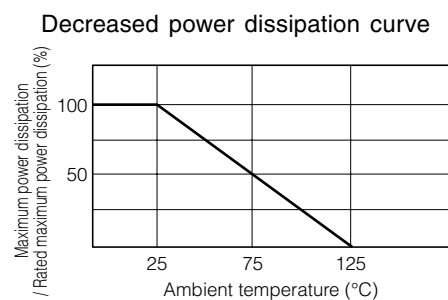

[Dissipation factor]

·The constant amount power required to raise the temperature of the Thermistor 1 °C through self heat generation under stable temperatures.
 Dissipation factor (mW/°C) = Power consumption of Thermistor / Temperature rise of element

1.3 Environmental Restrictions

The Thermistors shall not be operated and/or stored under the following conditions.

- (1) Environmental conditions
 - (a) Under direct exposure to water or salt water
 - (b) Under conditions where water can condense and/or dew can form
 - (c) Under conditions containing corrosive gases such as hydrogen sulfide, sulfurous acid, chlorine and ammonia
- (2) Mechanical conditions

Under severe conditions of vibration or impact beyond the specified conditions found in the Specifications.

1.4 Measurement of Resistance

The resistance of the Thermistors varies dependent on ambient temperatures and self-heating. Note the following points when measuring resistance values of the Thermistors during inspection or when considering them for circuits.

- ① Measurement temp : 25 ± 0.1 °C

Measurement in liquid (silicon oil, etc.) is recommended for a stable measurement temperature.
- ② Power : 0.10 mW max.

4 terminal measurement with a constant-current power supply is recommended.

2. Design of Printed Circuit Board

2.1 Selection of Printed Circuit Boards

When the Thermistors are mounted and soldered on an "Alumina Substrate", the substrate influences the Thermistors' reliability against "Temperature Cycles" and "Heat shock" due to the difference in the thermal expansion coefficient between them. Confirm that the actual board used does not deteriorate the characteristics of the Thermistors.

2.2 Design of Land Pattern

- (1) Recommended land dimensions are shown below. Use the proper amount of solder in order to prevent cracking. Using too much solder places excessive stress on the Thermistors.

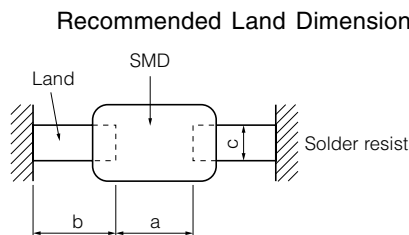

Unit (mm)

| Size Code (EIA) | Component dimensions | | | a | b | c |
|-----------------|----------------------|-----|-----|------------|--------------|------------|
| | L | W | T | | | |
| Z(0201) | 0.6 | 0.3 | 0.3 | 0.2 to 0.3 | 0.25 to 0.30 | 0.2 to 0.3 |
| O(0402) | 1.0 | 0.5 | 0.5 | 0.4 to 0.5 | 0.4 to 0.5 | 0.4 to 0.5 |
| 1(0603) | 1.6 | 0.8 | 0.8 | 0.8 to 1.0 | 0.6 to 0.8 | 0.6 to 0.8 |

- (2) The size of lands shall be designed to have equal spacing between the right and left sides. If the amount of solder on the right land is different from that on the left land, the component may be cracked by stress since the side with a larger amount of solder solidifies later during cooling.

Recommended Amount of Solder

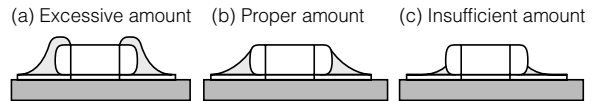

2.3 Utilization of Solder Resist

- (1) Solder resist shall be utilized to equalize the amounts of solder on both sides.
- (2) Solder resist shall be used to divide the pattern for the following cases;
 - Components are arranged closely.
 - The Thermistor is mounted near a component with lead wires.
 - The Thermistor is placed near a chassis.

See the table below.

Prohibited Applications and Recommended Applications

| Item | Prohibited applications | Improved applications by pattern division |
|---|---|---|
| Mixed mounting with a component with lead wires | The lead wire of a component with lead wires | Solder resist |
| Arrangement near chassis | Chassis Solder (Ground solder) Electrode pattern | Solder resist |
| Retro-fitting of component with lead wires | Soldering iron A lead wire of Retro-fitted component | Solder resist |
| Lateral arrangement | Portion to be excessively soldered Land | Solder resist |

2.4 Component Layout

The Thermistors/components shall be placed on the PC board such that both electrodes are subjected to uniform stresses, or to position the component electrodes at right angles to the grid groove or bending line. This should be done to avoid cracking the Thermistors from bending the PC board after or during placing/mounting on the PC board. Placement of the Thermistors near heating elements also requires that great care be taken in order to avoid stresses from rapid heating and cooling.

- (1) To minimize mechanical stress caused by the warp or bending of a PC board, please follow the recommended Thermistors' layout below.

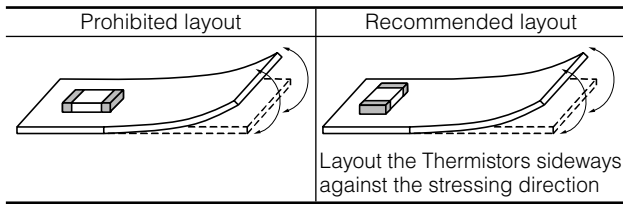

- (2) The following layout is for your reference since mechanical stress near the dividing/breaking position of a PC board varies depending on the mounting position of the Thermistors.

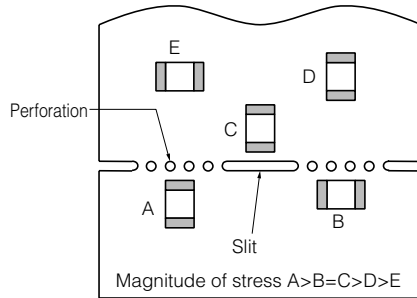

- (3) The magnitude of mechanical stress applied to the Thermistors when the circuit board is divided is in the order of push back < slit < V-groove < perforation. Also take into account the layout of the Thermistors and the dividing/breaking method.
- (4) When the Thermistors are placed near heating elements such as heater, etc., cracks from thermal stresses may be caused by the following:
- Soldering the Thermistors directly heating elements.
 - Mounting the Thermistors on the same land that another Thermistor is mounted on.

For the above-mentioned mounting and/or placement, please contact us in advance,

2.5 Mounting Density and Spaces

If components are arranged in too narrow a space, the components can be affected by solder bridges and solder balls. The space between components should be carefully determined.

Precautions for Assembly

1. Storage

- (1) The Thermistors shall be stored between 5 - 40 °C and 20 - 70 % RH, not under severe conditions of high temperature and humidity.
- (2) If stored in a place that is humid, dusty, or contains corrosive gasses (hydrogen sulfide, sulfurous acid, hydrogen chloride and ammonia etc.), the solderability of terminal electrodes may deteriorate. In addition, storage in a place subjected to heating and/or exposure to direct sunlight will cause deformed tapes and reels, and component sticking to tapes, both of which can result in mounting problems
- (3) Do not store components longer than 6 months. Check the solderability of products that have been stored for more than 6 months before use

2. Chip Mounting Consideration

- (1) When mounting the Thermistors/components on a PC board, the Thermistor bodies shall be free from excessive impact loads such as mechanical impact or stress due to the positioning, pushing force and displacement of vacuum nozzles during mounting.
- (2) Maintenance and inspection of the Chip Mounter must be performed regularly.
- (3) If the bottom dead center of the vacuum nozzle is too low, the Thermistor will crack from excessive force during mounting.

The following precautions and recommendations are for your reference in use.

- (a) Set and adjust the bottom dead center of the vacuum nozzles to the upper surface of the PC board after correcting the warp of the PC board.
- (b) Set the pushing force of the vacuum nozzle during mounting to 1 to 3 N in static load.
- (c) For double surface mounting, apply a supporting pin on the rear surface of the PC board to suppress the bending of the PC board in order to minimize the impact of the vacuum nozzles. Typical examples are shown in the table below.

| Item | Prohibited mounting | Recommended mounting |
|-------------------------|---------------------|----------------------|
| Single surface mounting | | |
| Double surface mounting | | |

- (d) Adjust the vacuum nozzles so that their bottom dead center during mounting is not too low.
- (4) The closing dimensions of the positioning chucks shall be controlled. Maintenance and replacement of positioning chucks shall be performed regularly to prevent chipping or cracking of the Thermistors caused by mechanical impact during positioning due to worn positioning chucks.
 - (5) Maximum stroke of the nozzle shall be adjusted so that the maximum bending of PC board does not exceed 0.5 mm at 90 mm span. The PC board shall be supported by an adequate number of supporting pins.

3. Selection of Soldering Flux

Soldering flux may seriously affect the performance of the Thermistors. The following shall be confirmed before use.

- (1) The soldering flux should have a halogen based content of 0.1 wt% (converted to chlorine) or below. Do not use soldering flux with strong acid.
- (2) When applying water-soluble soldering flux, wash the Thermistors sufficiently because the soldering flux residue on the surface of PC boards may deteriorate the insulation resistance on the Thermistors' surface.

4. Soldering

4.1 Reflow Soldering

The reflow soldering temperature conditions are each temperature curves of Preheating, Temp. rise, Heating, Peak and Gradual cooling. Large temperature difference caused by rapid heat application to the Thermistors may lead to excessive thermal stresses, contributing to the thermal cracks. The Preheating temperature requires controlling with great care so that tombstone phenomenon may be prevented.

| Item | Temperature | Period or Speed |
|------------------|-------------------------------|-----------------|
| ①Preheating | 140 to 180 °C | 60 to 120 sec |
| ②Temp. rise | Preheating temp to Peak temp. | 2 to 5 °C /sec |
| ③Heating | 220 °C min. | 60 sec max. |
| ④Peak | 260 °C max. | 10 sec max. |
| ⑤Gradual cooling | Peak temp. to 140 °C | 1 to 4 °C /sec |

Recommended profile of Reflow soldering (EX)

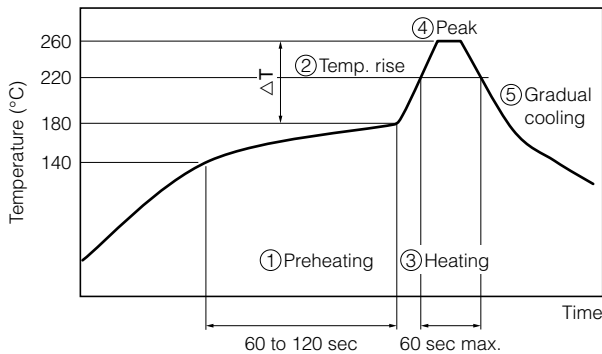

ΔT : Allowable temperature difference $\Delta T \leq 150 \text{ }^\circ\text{C}$

The rapid cooling (forced cooling) during Gradual cooling part should be avoided, because this may cause defects such as the thermal cracks, etc.

When the Thermistors are immersed into a cleaning solvent, make sure that the surface temperatures of the devices do not exceed 100 °C.

Performing reflow soldering twice under the conditions shown in the figure above [Recommended profile of Reflow soldering (EX)] will not cause any problems. However, pay attention to the possible warp and bending of the PC board.

4.2 Hand Soldering

Hand soldering typically causes significant temperature change, which may induce excessive thermal stresses inside the Thermistors, resulting in the thermal cracks, etc. In order to prevent any defects, the following should be observed.

- The temperature of the soldering tips should be controlled with special care.
- The direct contact of soldering tips with the Thermistors and/or terminal electrodes should be avoided.
- Dismounted Thermistors shall not be reused.

(1) Condition 1 (with preheating)

(a) Soldering:

ϕ 1.0 mm or below Thread eutectic solder with soldering flux* in the core.

* Rosin-based and non-activated flux is recommended.

(b) Preheating:

The Thermistors shall be preheated so that the "Temperature Gradient" between the devices and the tip of soldering iron is 150 °C or below.

(c) Temperature of Iron tip: 300 °C max.

(The required amount of solder shall be melted in advance on the soldering tip.)

(d) Gradual cooling:

After soldering, the Thermistors shall be cooled gradually at room temperature.

Recommended profile of Hand soldering (EX)

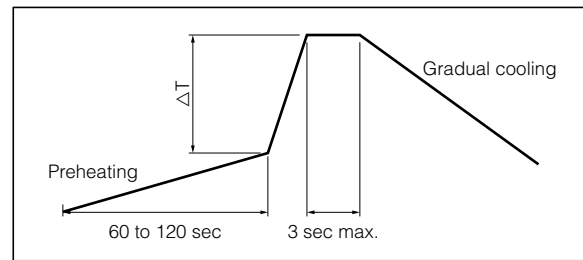

ΔT : Allowable temperature difference $\Delta T \leq 150 \text{ }^\circ\text{C}$

(2) Condition 2 (without preheating)

Hand soldering can be performed without preheating, by following the conditions below:

(a) Soldering iron tip shall never directly touch the ceramic and terminal electrodes of the Thermistors.

(b) The lands are sufficiently preheated with a soldering iron tip before sliding the soldering iron tip to the terminal electrodes of the Thermistors for soldering.

Conditions of Hand soldering without preheating

| Item | Condition |
|--------------------------------------|------------------|
| Temperature of Iron tip | 270 °C max. |
| Wattage | 20 W max. |
| Shape of Iron tip | ϕ 3 mm max. |
| Soldering time with a soldering iron | 3 sec max. |

5. Post Soldering Cleaning

5.1 Cleaning solvent

Soldering flux residue may remain on the PC board if cleaned with an inappropriate solvent. This may deteriorate the electrical characteristics and reliability of the Thermistors.

5.2 Cleaning conditions

Inappropriate cleaning conditions such as insufficient cleaning or excessive cleaning may impair the electrical characteristics and reliability of the Thermistors.

(1) Insufficient cleaning can lead to:

- (a) The halogen substance found in the residue of the soldering flux may cause the metal of terminal electrodes to corrode.
- (b) The halogen substance found in the residue of the soldering flux on the surface of the Thermistors may change resistance values.
- (c) Water-soluble soldering flux may have more remarkable tendencies of (a) and (b) above compared to those of rosin soldering flux.

- (2) Excessive cleaning can lead to:
- (a) Overuse of ultrasonic cleaning may deteriorate the strength of the terminal electrodes or cause cracking in the solder and /or ceramic bodies of the Thermistors due to vibration of the PC boards. Please follow these conditions for Ultrasonic cleaning:
 - Ultrasonic wave output : 20 W/L max.
 - Ultrasonic wave frequency : 40 kHz max.
 - Ultrasonic wave cleaning time : 5 min. max.

5.3 Contamination of Cleaning solvent

Cleaning with contaminated cleaning solvent may cause the same results as insufficient cleaning due to the high density of liberated halogen.

6. Inspection Process

When mounted PC boards are inspected with measuring terminal pins, abnormal and excess mechanical stress shall not be applied to the PC board or mounted components, to prevent failure or damage to the devices.

- (1) Mounted PC boards shall be supported by an adequate number of supporting pins with bend settings of 90 mm span 0.5 mm max.
 - (2) Confirm that the measuring pins have the right tip shape, are equal in height and are set in the correct positions.
- The following figures are for your reference to avoid bending the PC board.

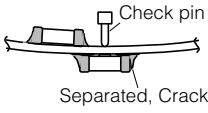
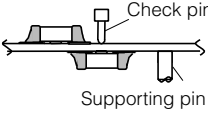
| Item | Prohibited setting | Recommended setting |
|---------------------|---|---|
| Bending of PC board |  <p>Separated, Crack</p> |  <p>Supporting pin</p> |

7. Protective Coating

When the surface of a PC board on which the Capacitors have been mounted is coated with resin to protect against moisture and dust, it shall be confirmed that the protective coating which is corrosive or chemically active is not used, in order that the reliability of the Thermistors in the actual equipment may not be influenced. Coating materials that expand or shrink also may lead to damage to the Thermistors during the curing process.

8. Dividing/Breaking of PC Boards

- (1) Abnormal and excessive mechanical stress such as bending or torsion shown below can cause cracking in the Thermistors.

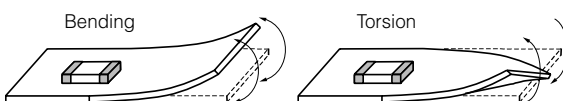

- (2) Dividing/Breaking of the PC boards shall be done carefully at moderate speed by using a jig or apparatus to prevent the Thermistors on the boards from mechanical damage.

- (3) Examples of PCB dividing/breaking jigs:
 - The outline of PC board breaking jig is shown below. When PC boards are broken or divided, loading points should be close to the jig to minimize the extent of the bending
 - Also, planes with no parts mounted on should be used as plane of loading, which generates a compressive stress on the mounted plane, in order to prevent tensile stress induced by the bending, which may cause cracks of the Thermistors or other parts mounted on the PC boards.

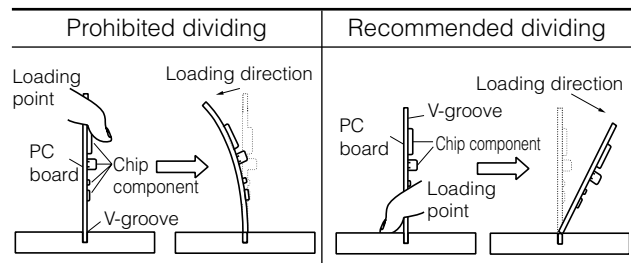
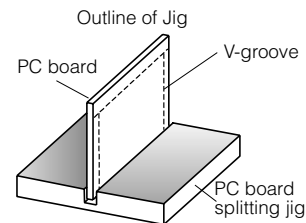

9. Mechanical Impact

- (1) The Thermistors shall be free from any excessive mechanical impact. The Thermistor body is made of ceramics and may be damaged or cracked if dropped. Never use a Thermistor which has been dropped; their quality may be impaired and failure rate increased.
- (2) When handling PC boards with Thermistors mounted on them, do not allow the Thermistors to collide with another PC board. When mounted PC boards are handled or stored in a stacked state, impact between the corner of a PC board and the Thermistor may cause damage or cracking and can deteriorate the withstand voltage and insulation resistance of the Thermistor.

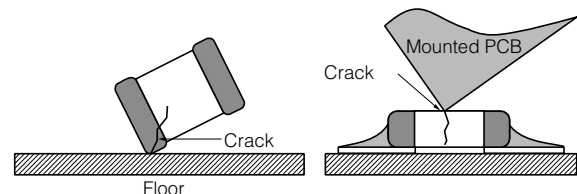

Other

The various precautions described above are typical. For special mounting conditions, please contact us.