

1.2A, 1.4MHz High Efficiency Synchronous DC-DC Buck Converter AP3417B

General Description

The AP3417B is a 1.4MHz fixed frequency, current mode, PWM synchronous buck (step-down) DC-DC converter, capable of driving a 1.2A load with high efficiency, excellent line and load regulation. The device integrates synchronous P-channel and N-channel power MOSFET switches with low on-resistance. It is ideal for powering portable equipment that runs from a single Li-ion battery.

A standard series of inductors are available from several different manufacturers optimized for use with the AP3417B. This feature greatly simplifies the design of switch-mode power supplies.

The AP3417B is available in SOT-23-5 package.

Features

- Input Voltage Range: 2.5V to 5.5V
- Output Voltage: 0.6V to V_{IN}
- ADJ Output
- Fixed 1.4MHz Frequency
- High Efficiency up to 95%
- Output Current: 1.2A
- Current Mode Control
- 100% Duty Cycle in Dropout
- Built-in Over Current Protection
- Built-in Short Circuit Protection
- Built-in Thermal Shutdown Protection
- Built-in UVLO Function
- Built-in Soft-start
- Built-in Input Over Voltage Protection (IOVP)

Applications

- Set-top Box
- Datacom
- Portable Device
- Smart Phone

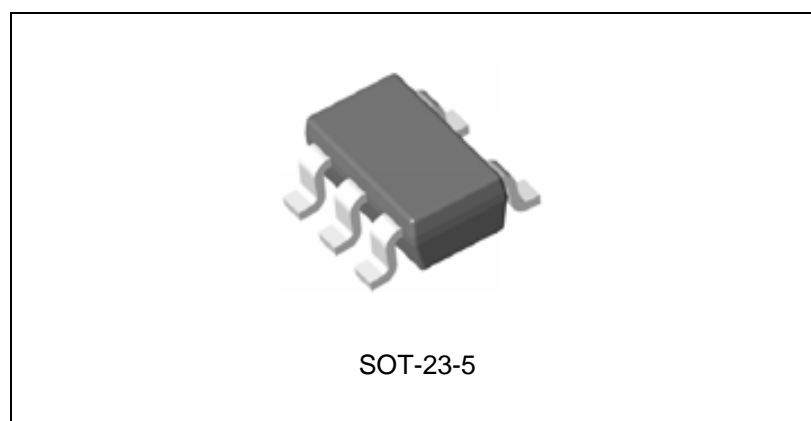

Figure 1. Package Type of AP3417B

1.2A, 1.4MHz High Efficiency Synchronous DC-DC Buck Converter AP3417B

Pin Configuration

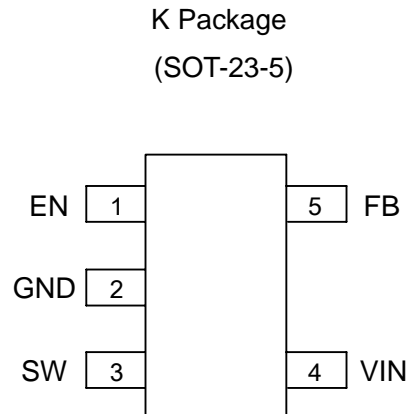

Figure 2. Pin Configuration of AP3417B (Top View)

Pin Description

Pin Number	Pin Name	Function
1	EN	Control input pin. Forcing this pin above 1.5V enables the IC. Forcing this pin below 0.4V shuts down the IC. When the IC is in shutdown mode, all functions are disabled to decrease the supply current below 1μA
2	GND	Ground pin
3	SW	Power switch output pin. Inductor connection to drain of the internal PFET and NFET switches
4	VIN	Supply input pin. Bypass to GND with a 4.7μF or greater ceramic capacitor
5	FB	This is the feedback pin of the device. Connect this pin directly to the output if the fixed output voltage version is used. For the adjustable version, an external resistor divider is connected to this pin

1.2A, 1.4MHz High Efficiency Synchronous DC-DC Buck Converter AP3417B

Functional Block Diagram

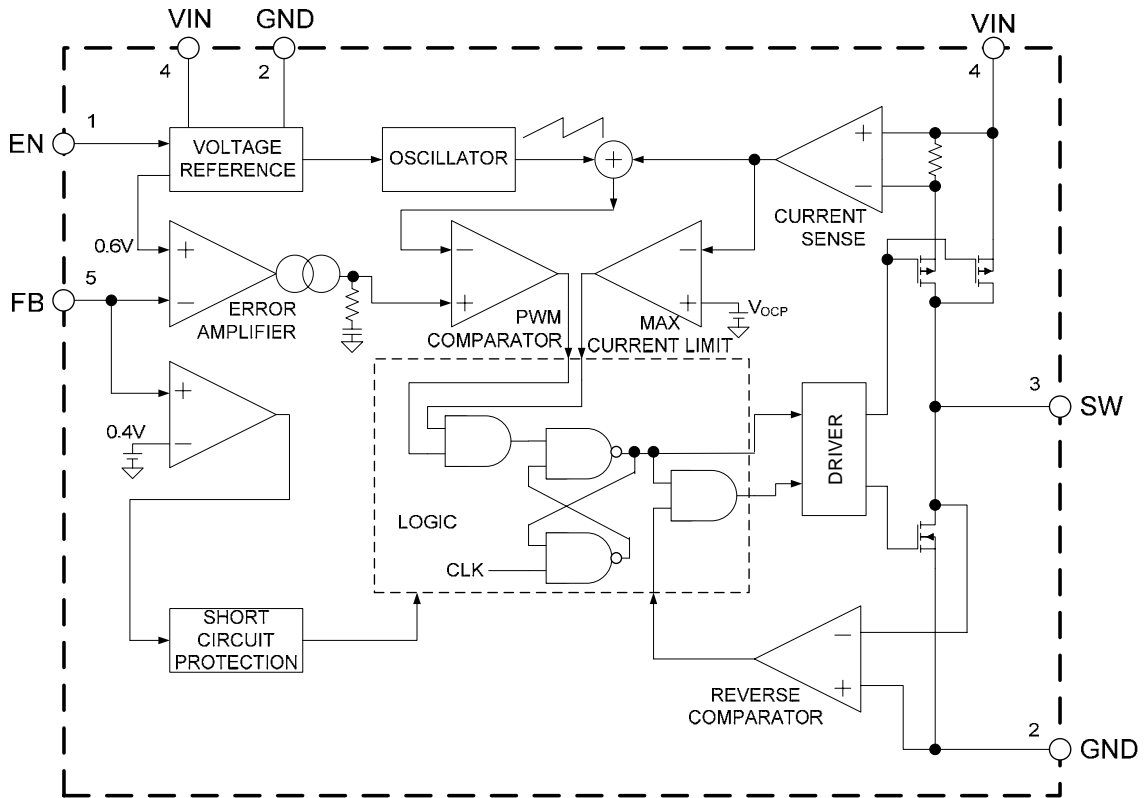
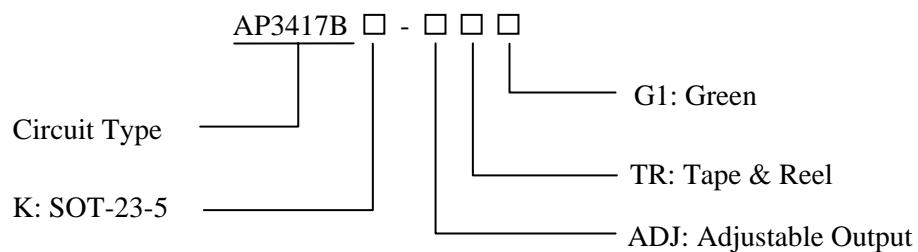

Figure 3. Functional Block Diagram of AP3417B

Ordering Information



Package	Temperature Range	Part Number	Marking ID	Packing Type
SOT-23-5	-40 to 85°C	AP3417BK-ADJTRG1	G2J	Tape & Reel

BCD Semiconductor's Pb-free products, as designated with "G1" suffix in the part number, are RoHS compliant and green.

**1.2A, 1.4MHz High Efficiency Synchronous DC-DC Buck Converter AP3417B****Absolute Maximum Ratings (Note 1)**

Parameter	Symbol	Value	Unit
Input Voltage	V_{IN}	-0.3 to 6.0	V
Feedback Voltage	V_{FB}	-0.3 to $V_{IN} + 0.3$	V
EN Pin Voltage	V_{EN}	-0.3 to $V_{IN} + 0.3$	V
SW Pin Voltage	V_{SW}	-0.3 to $V_{IN} + 0.3$	V
Thermal Resistance	θ_{JA}	265	°C/W
Operating Junction Temperature	T_J	150	°C
Storage Temperature	T_{STG}	-65 to 150	°C
Lead Temperature (Soldering, 10sec)	T_{LEAD}	260	°C
ESD(Machine Model)		200	V
ESD(Human Body Model)		2000	V

Note 1: Stresses greater than those listed under “Absolute Maximum Ratings” may cause permanent damage to the device. These are stress ratings only, and functional operation of the device at these or any other conditions beyond those indicated under “Recommended Operating Conditions” is not implied. Exposure to “Absolute Maximum Ratings” for extended periods may affect device reliability.

Recommended Operating Conditions

Parameter	Symbol	Min	Max	Unit
Input Voltage	V_{IN}	2.5	5.5	V
Operating Ambient Temperature	T_A	-40	85	°C



1.2A, 1.4MHz High Efficiency Synchronous DC-DC Buck Converter AP3417B

Electrical Characteristics

$V_{IN}=5V$, $T_A=25^{\circ}C$, unless otherwise specified.

Parameters	Symbol	Conditions	Min	Typ	Max	Unit
Input Voltage	V_{IN}		2.5		5.5	V
Quiescent Current	I_Q	$V_{FB}=0.65V$		62	100	μA
Shutdown Supply Current	I_{STBY}	$V_{EN}=GND$		0.1	1	μA
Reference Voltage	V_{REF}		0.588	0.6	0.612	V
Feedback Bias Current	I_{FB_H}	$V_{FB}=1V$	-0.1		0.1	μA
	I_{FB_L}	$V_{FB}=0V$	-0.1		0.1	
PMOSFET R_{ON}	$R_{DS(ON)_P}$	$I_{SW}=200mA$		0.25		Ω
NMOSFET R_{ON}	$R_{DS(ON)_N}$	$I_{SW}=-200mA$		0.2		Ω
Switch Current Limit	I_{LIM}	$V_{FB}=0.55V$	1.5	2.0		A
EN Pin Threshold	V_H		1.5			V
	V_L				0.4	
UVLO Threshold	V_{UVLO}	V_{IN} Rising		2.3		V
UVLO Hysteresis	V_{HYS}			0.2		
Oscillator Frequency	f_{OSC}		1.12	1.40	1.68	MHz
Max. Duty Cycle	D_{MAX}		100			%
Min. Duty Cycle	D_{MIN}				0	
SW Leakage Current	I_{SW_H}	$V_{SW}=0V$		0.1		μA
	I_{SW_L}	$V_{SW}=5V$		0.1		
Soft-start Time	t_{SS}			1		ms
Thermal Shutdown	T_{OTSD}			160		$^{\circ}C$
Thermal Shutdown Hysteresis	T_{HYS}			20		$^{\circ}C$
Input OVP Threshold	V_{IOVP}	V_{IN} Rising		6.3		V
Input OVP Hysteresis	V_{IOVP_HYS}			0.5		V

1.2A, 1.4MHz High Efficiency Synchronous DC-DC Buck Converter AP3417B

Typical Performance Characteristics

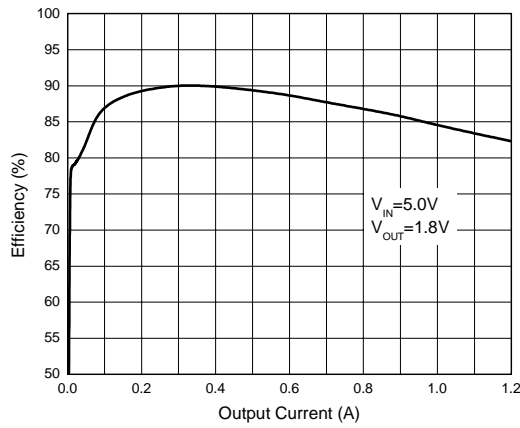

Figure 4. Efficiency vs. Output Current

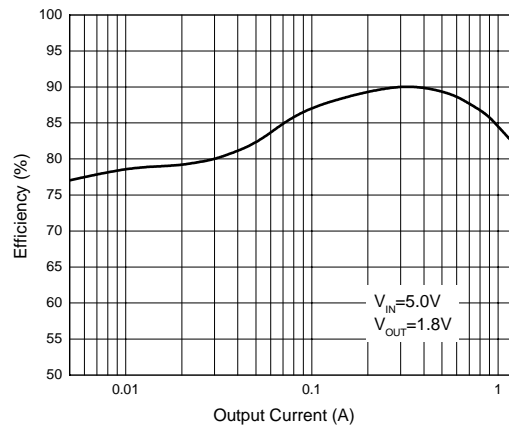

Figure 5. Efficiency vs. Output Current

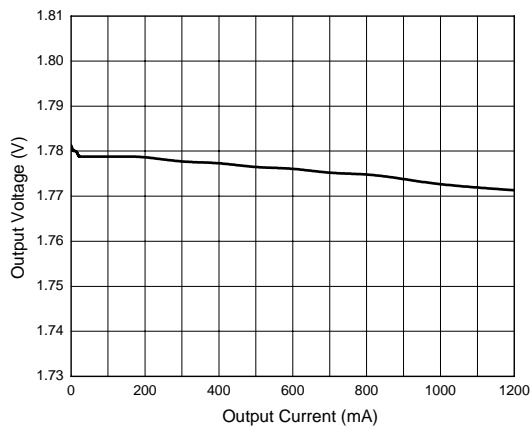

Figure 6. Output Voltage vs. Output Current

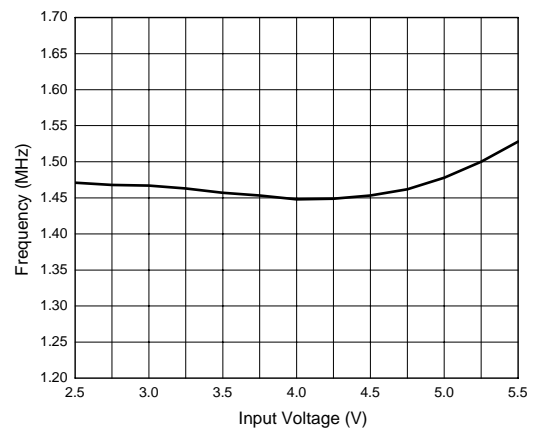

Figure 7. Frequency vs. Input Voltage

1.2A, 1.4MHz High Efficiency Synchronous DC-DC Buck Converter AP3417B

Typical Performance Characteristics (Continued)

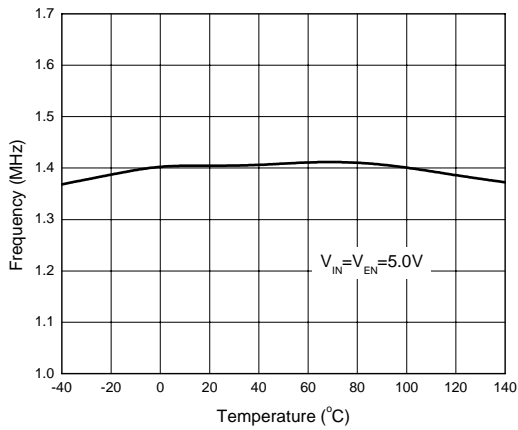

Figure 8. Frequency vs. Temperature

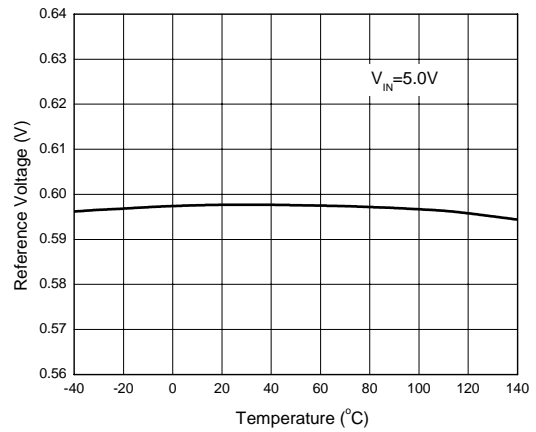

Figure 9. Reference Voltage vs. Temperature

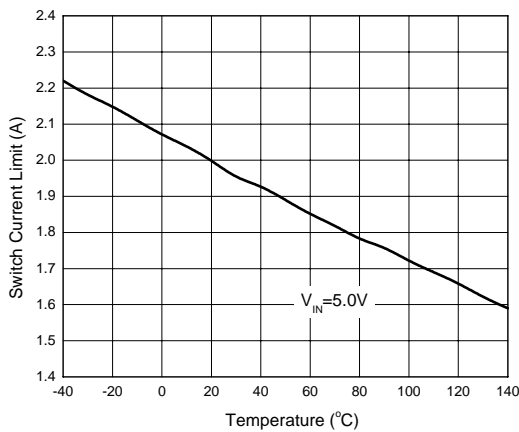

Figure 10. Switch Current Limit vs. Temperature

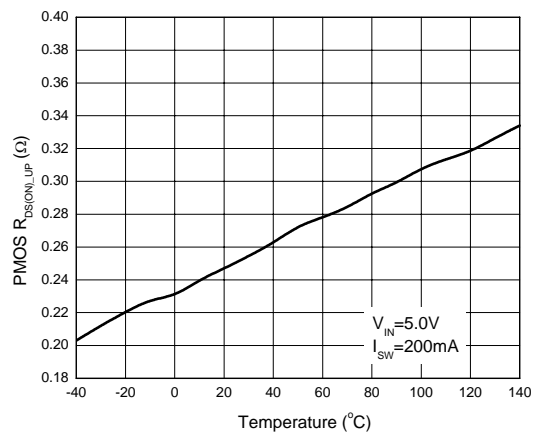

Figure 11. R_DS(ON)_UP vs. Temperature

1.2A, 1.4MHz High Efficiency Synchronous DC-DC Buck Converter AP3417B

Typical Performance Characteristics (Continued)

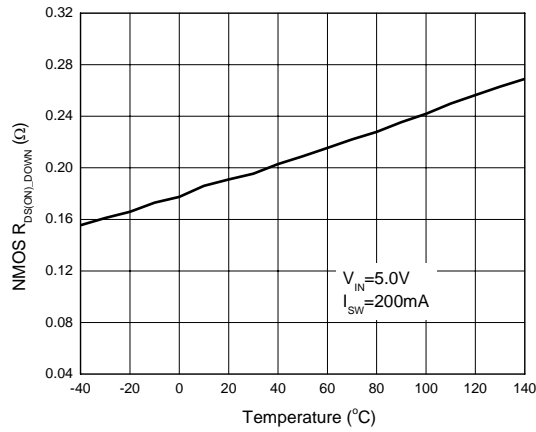

Figure 12. $R_{DS(ON)_DOWN}$ vs. Temperature

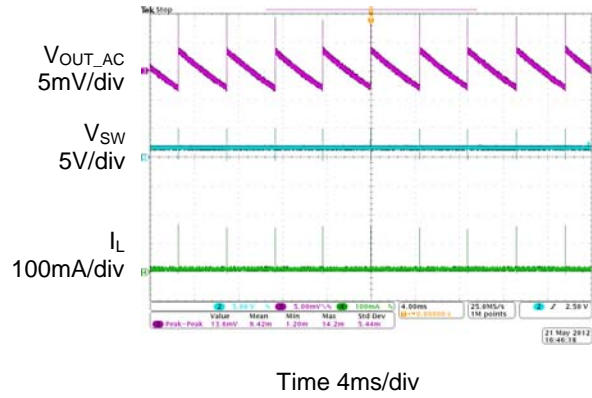

Figure 13. Output Ripple ($I_{OUT}=0A$)

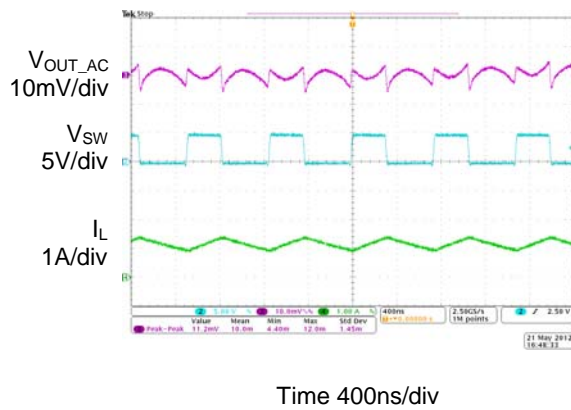

Figure 14. Output Ripple ($I_{OUT}=1.2A$)

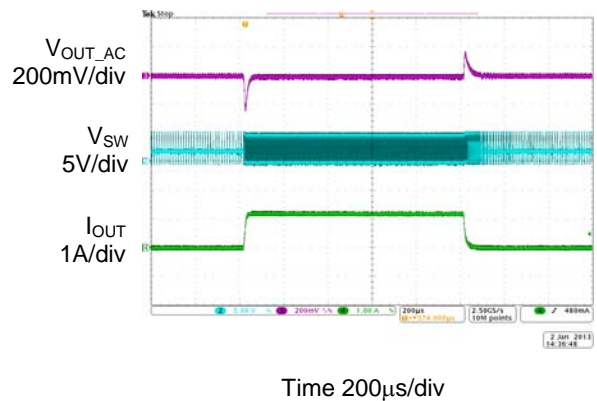
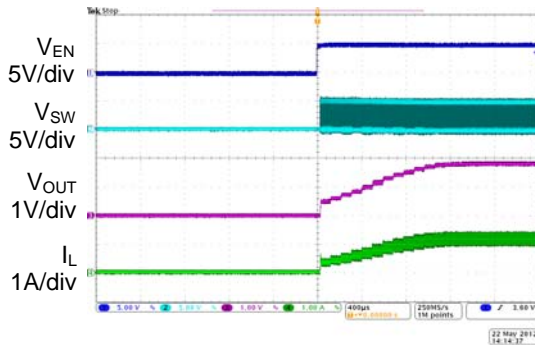

Figure 15. Load Transient ($I_{OUT}=0A$ to $1.2A$)

1.2A, 1.4MHz High Efficiency Synchronous DC-DC Buck Converter AP3417B

Typical Performance Characteristics (Continued)



Time 400 μ s/div

Figure 16. Enable Turn On ($I_{OUT}=1.2A$)

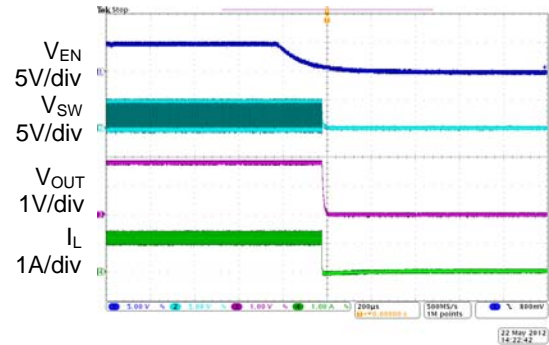

Time 200 μ s/div

Figure 17. Enable Turn Off ($I_{OUT}=1.2A$)

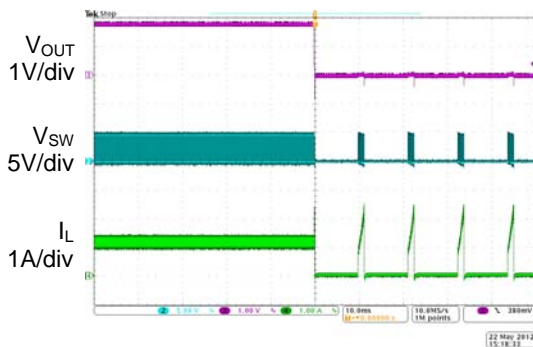

Time 10ms/div

Figure 18. Short Circuit Protection ($I_{OUT}=1.2A$)

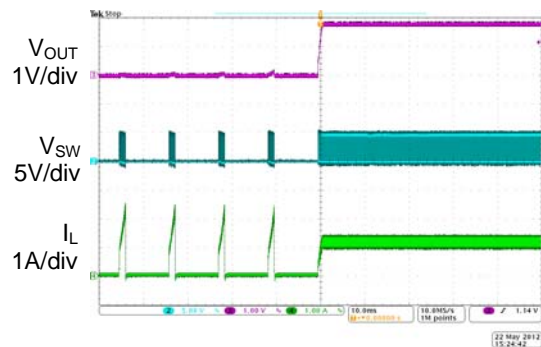

Time 10ms/div

Figure 19. Short Circuit Protection Recovery ($I_{OUT}=1.2A$)

1.2A, 1.4MHz High Efficiency Synchronous DC-DC Buck Converter AP3417B

Typical Performance Characteristics (Continued)

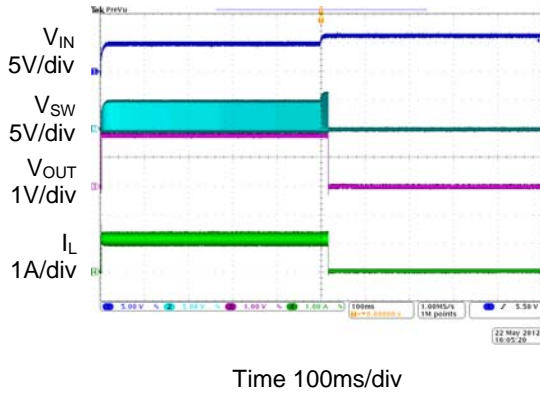

Figure 20. Over Voltage Protection ($I_{OUT}=1.2A$)

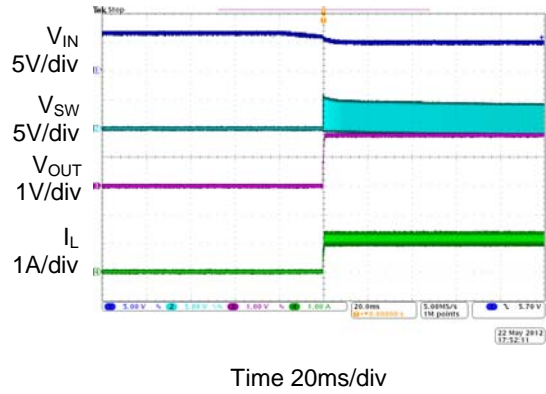

Figure 21. Over Voltage Protection Recovery ($I_{OUT}=1.2A$)

1.2A, 1.4MHz High Efficiency Synchronous DC-DC Buck Converter AP3417B

Typical Application

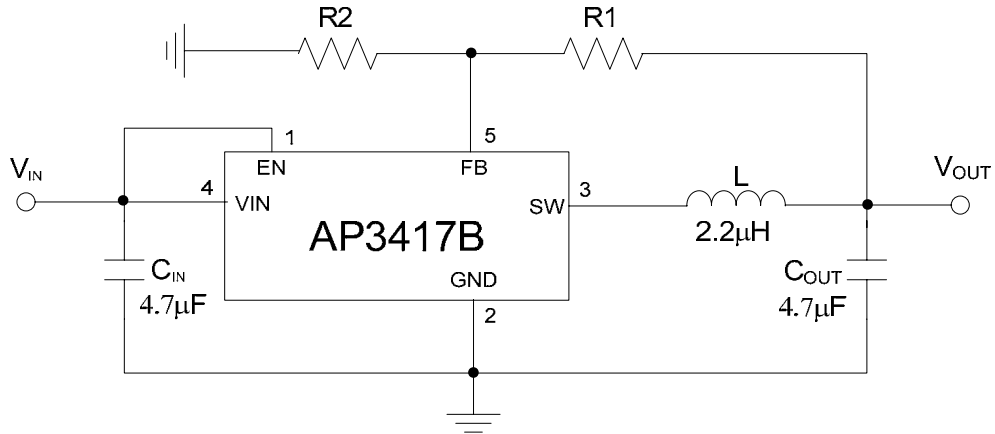

Figure 22. Typical Application of AP3417B



BCD Semiconductor Manufacturing Limited

<http://www.bcdsemi.com>

IMPORTANT NOTICE

BCD Semiconductor Manufacturing Limited reserves the right to make changes without further notice to any products or specifications herein. BCD Semiconductor Manufacturing Limited does not assume any responsibility for use of any its products for any particular purpose, nor does BCD Semiconductor Manufacturing Limited assume any liability arising out of the application or use of any its products or circuits. BCD Semiconductor Manufacturing Limited does not convey any license under its patent rights or other rights nor the rights of others.

MAIN SITE

- Headquarters

BCD Semiconductor Manufacturing Limited

No. 1600, Zi Xing Road, Shanghai ZiZhu Science-based Industrial Park, 200241, China
Tel: +86-21-24162266, Fax: +86-21-24162277

- Wafer Fab

Shanghai SIM-BCD Semiconductor Manufacturing Co., Ltd.

800 Yi Shan Road, Shanghai 200233, China
Tel: +86-21-6485 1491, Fax: +86-21-5450 0008

REGIONAL SALES OFFICE

Shenzhen Office

Shanghai SIM-BCD Semiconductor Manufacturing Co., Ltd., Shenzhen Office

Unit A Room 1203, Skyworth Bldg., Gaoxin Ave. 1.S., Nanshan District, Shenzhen, China
Tel: +86-755-8826 7951
Fax: +86-755-8826 7865

Taiwan Office

BCD Semiconductor (Taiwan) Company Limited

4F, 298-1, Rui Guang Road, Nei-Hu District, Taipei, Taiwan
Tel: +886-2-2656 2808
Fax: +886-2-2656 2806

USA Office

BCD Semiconductor Corp.

30920 Huntwood Ave. Hayward, CA 94544, USA
Tel : +1-510-324-2988
Fax: +1-510-324-2788