

General Description

The AAT2862 is a highly integrated charge pump-based lighting management unit with four linear regulators optimized for single-cell lithium-ion/polymer systems. The charge pump provides power for all LED outputs and multiple LED configurations are available. The LED outputs can be programmed up to 30mA each and two LED outputs can be programmed up to 60mA each. An I²C serial digital interface is used to enable, disable, and set the current to one of 32 levels. Current matching is better than 3% for uniform display brightness, and high current matching is better than 5% for uniform power dissipation.

The AAT2862 also offers four high-performance low-noise MicroPower™ low dropout (LDO) linear regulators. The regulators are enabled and their output voltages are set through the I²C serial interface. Each LDO can supply up to 200mA load current and ground-pin current is only 80μA making the AAT2862 ideal for battery-operated applications.

The AAT2862 is available in a Pb-free, space saving TQFN34-24 package and operates over the -40°C to +85°C ambient temperature range.

Features

- Input Voltage Range: 2.7V to 5.5V
- Tri-Mode Charge Pump
 - Drives up to Eight LEDs
 - 32 Programmable Backlight Current with Auto-fade
 - Settings Ranging From 500μA to 30mA
 - Drives up to Two Auxiliary LEDs
 - 1MHz Switching Frequency
 - Automatic Soft Start
 - I²C Selectable Drivers
- Four Linear Regulators
 - 200mA Output Current
 - 200mV Dropout
 - I²C Programmable Output Voltage from 1.2V to 3.3V
 - Output Auto-Discharge for Fast Shutdown
- Built-In Thermal Protection
- Automatic Soft Start
- -40°C to +85°C Temperature Range
- TQFN34-24 Package

Applications

- Camera Enabled Mobile Devices
- Digital Still Cameras
- Multimedia Mobile Phones

Typical Application

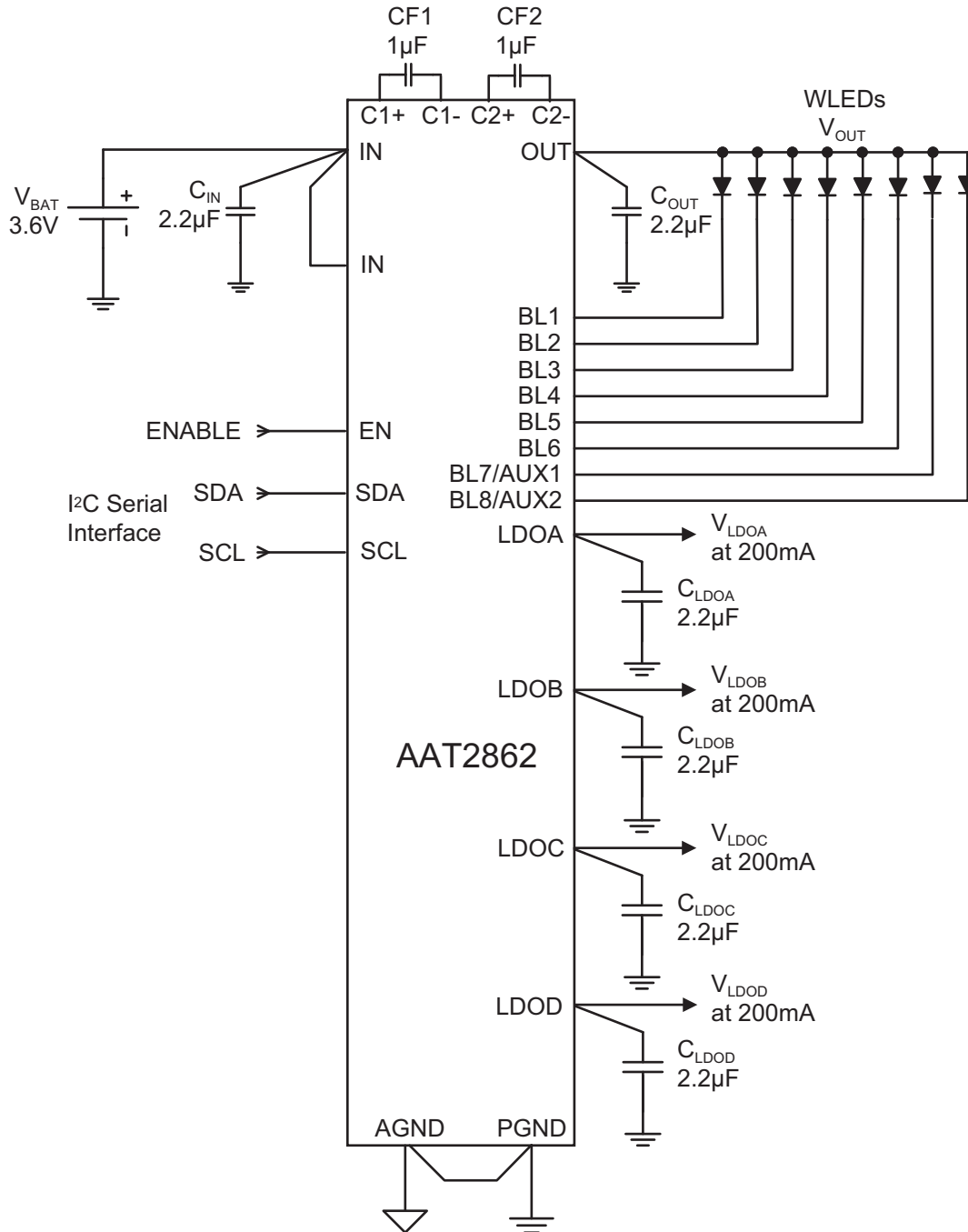

Pin Descriptions

Pin #	Symbol	Function	Description
1	OUT	O	Charge pump output. OUT is the output of the charge pump and supplies current to the backlight and flash LEDs. Connect the backlight and flash LED anodes to OUT. Bypass OUT to PGND with a 2.2μF or larger ceramic capacitor as close to the AAT2862 as possible.
2	C2+	I	Positive terminal of charge pump capacitor 2. Connect the 1μF charge pump capacitor 2 from C2+ to C2-.
3	SDA	I	I ² C serial data input. SDA is the data input of the I ² C serial interface. Drive SDA with the I ² C data.
4	SCL	I	I ² C serial clock input. SCL is the clock input of the I ² C serial interface. Drive SCL with the I ² C clock.
5	EN	I	Programming Enable Input. When EN is strobed high, the backlight and LDO registers can be programmed via the I ² C serial interface. When EN is strobed low, all backlight and LDO outputs are turned off and the backlight and LDO registers are reset to their default (POR) values and forces all LDO outputs to 0 (zero) volts.
6	AGND	G	Analog ground. Connect to PGND as close to the AAT2862 as possible.
7	IN	PI	Input power pin for all four LDOs. Connect Pin 7 to Pin 23 with as short a PCB trace as practical.
8	LDOC	O	LDO C regulated voltage output. Bypass LDOC to AGND with a 2.2μF or larger ceramic capacitor as close to the AAT2862 as possible.
9	LDOB	O	LDO B regulated voltage output. Bypass LDOB to AGND with a 2.2μF or larger capacitor as close to the AAT2862 as possible.
10	LDOA	O	LDO A regulated voltage output. Bypass LDOA to AGND with a 2.2μF or larger capacitor as close to the AAT2862 as possible.
11	LDOD	O	LDO D regulated voltage output. Bypass LDOD to AGND with a 2.2μF or larger ceramic capacitor as close to the AAT2862 as possible.
12	BL1	O	Backlight LED 1 current sink. BL1 controls the current through backlight LED 1. Connect the cathode of backlight LED 1 to BL1. If not used, connect BL1 to OUT.
13	BL2	O	Backlight LED 2 current sink. BL2 controls the current through backlight LED 2. Connect the cathode of backlight LED 2 to BL2. If not used, connect BL2 to OUT.
14	BL3	O	Backlight LED 3 current sink. BL3 controls the current through backlight LED 3. Connect the cathode of backlight LED 3 to BL3. If not used, connect BL3 to OUT.
15	BL4	O	Backlight LED 4 current sink. BL4 controls the current through backlight LED 4. Connect the cathode of backlight LED 4 to BL4. If not used, connect BL4 to OUT.
16	BL8/ AUX2	O	Backlight or Auxiliary LED 8 current sink. BL8 controls the current through backlight LED 8. Connect the cathode of backlight LED 8 to BL8. If not used, connect BL8 to OUT.
17	BL7/ AUX1	O	Backlight or Auxiliary LED 7 current sink. BL7 controls the current through backlight LED 7. Connect the cathode of backlight LED 7 to BL7. If not used, connect BL7 to OUT.
18	BL6	O	Backlight LED 6 current sink. BL6 controls the current through backlight LED 6. Connect the cathode of backlight LED 6 to BL6. If not used, connect BL6 to OUT.
19	BL5	O	Backlight LED 5 current sink. BL5 controls the current through backlight LED 5. Connect the cathode of backlight LED 5 to BL5. If not used, connect BL5 to OUT.
20	PGND	G	Power ground. Connect to AGND as close to the AAT2862 as possible.
21	C2-	I	Negative terminal of charge pump capacitor 2.
22	C1-	I	Negative terminal of charge pump capacitor 1.
23	IN	PI	Power input. Connect IN to the input source voltage. Bypass IN to PGND with a 2.2μF or larger ceramic capacitor as close to the AAT2862 as possible.
24	C1+	I	Positive terminal of charge pump capacitor 1. Connect the 1μF charge pump capacitor 1 from C1+ to C1-.
EP			Exposed paddle (bottom) Connect to PGND/AGND as close to the AAT2862 as possible.

Pin Configuration

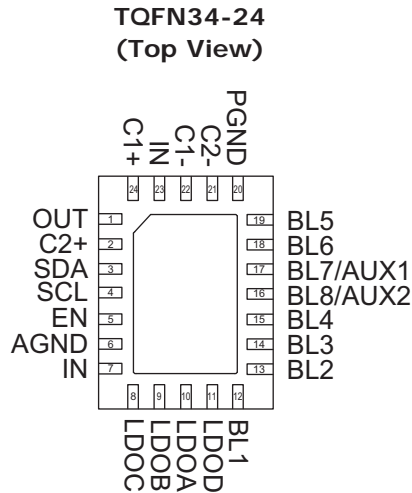

Programmable Options¹

Main Channels	Sub Channels	AUX Channels	AUX Channels with 2x I _{OUT}
8*	0*	0*	0*
6	2	0	0
5	3	0	0
5	2	1	0
4	4	0	0
4	3	1	0
4	2	2	0
5	2	0	1
4	2	0	2

1. "*" denotes default values.

Absolute Maximum Ratings¹

$T_A = 25^\circ\text{C}$ unless otherwise noted.

Symbol	Description	Value	Units
	IN, OUT, BL1, BL2, BL3, BL4, BL5, BL6, BL7/AUX1, BL8/AUX2 Voltage to PGND and AGND	-0.3 to 6.0	V
	C1+, C2+ Voltage to PGND and AGND	-0.3 to $V_{OUT} + 0.3$	V
	C1-, C2-, LDOA, LDOB, LDOC, LDOD, EN, SDA, SCL Voltage to PGND and AGND	-0.3 to $V_{IN} + 0.3$	V
	PGND to AGND	-0.3 to + 0.3	V

Thermal Information^{2, 3}

Symbol	Description	Value	Units
Θ_{JA}	Thermal Resistance	50	$^\circ\text{C}/\text{W}$
P_D	Maximum Power Dissipation	2	W
T_J	Operating Junction Temperature Range	-40 to 150	$^\circ\text{C}$
T_{LEAD}	Maximum Soldering Temperature (at Leads)	300	

1. Stresses above those listed in Absolute Maximum Ratings may cause permanent damage to the device. Functional operation at conditions other than the operating conditions specified is not implied. Only one Absolute Maximum Rating should be applied at any one time.

2. Derate 20mW/ $^\circ\text{C}$ above 25 $^\circ\text{C}$ ambient temperature.

3. Mounted on a FR4 circuit board.

Electrical Characteristics¹

$V_{IN} = 3.6V$; $C_{IN} = C_{OUT} = 2.2\mu F$; $C_1 = C_2 = 1\mu F$; $T_A = -40^{\circ}C$ to $+85^{\circ}C$, unless otherwise noted. Typical values are $T_A = 25^{\circ}C$.

Symbol	Description	Conditions	Min	Typ	Max	Units
V_{IN}	IN Operating Voltage Range		2.7		5.5	V
I_{IN}	IN Operating Current	1x Mode; $3.0 \leq V_{IN} \leq 5.5$; LDOs OFF; No Load		0.15	0.20	mA
		1.5x Mode; $3.0 \leq V_{IN} \leq 5.5$; LDOs OFF; Charge Pump ON; No Load			3.0	mA
		2x Mode; $3.0 \leq V_{IN} \leq 5.5$; LDOs OFF; Charge Pump ON; No Load			5.0	mA
		$2.7 \leq V_{IN} \leq 5.5$; All LDOs ON; Charge Pump OFF; No Load			225	μA
		$2.7 \leq V_{IN} \leq 5.5$; Any One LDO ON; Charge Pump OFF; No Load			80	μA
$I_{IN(SHDN)}$	IN Shutdown Current	EN = GND			1.0	μA
T_{SD}	Over-Temperature Shutdown Threshold			140		$^{\circ}C$
$T_{SD(HYS)}$	Over-Temperature Shutdown Hysteresis			15		$^{\circ}C$
Charge Pump Section						
V_{OUT}	OUT Output Voltage			5.2		V
$I_{OUT(MAX)}$	OUT Maximum Output Current	$V_{IN} = 3.0V, V_{OUT} = 4.0V$		800		mA
$V_{IN(TH_H, BL)}$	BL1-BL8 Charge Pump Mode Transition Hysteresis	EN/SET = IN; $V_{IN} - V_F = 1V$		300		mV
f_{OSC}	Charge Pump Oscillator Frequency	Address 07h Data=20 (0010 0000); $T_A = 25^{\circ}C$		1.2		MHz
$t_{CP(SS)}$	Charge Pump Soft-Start Time	$T_A = 25^{\circ}C$		100		μs
BL1-BL6, BL7/AUX1, BL8/AUX2 LED Drivers						
$t_{LED(SU)}$	LED Output Current Startup Time	OUT: 0V to IN		20		us
$I_{BL_ (MAX)}$	BL1-BL8 Maximum Current	Address 03h Data=E0 (1110 0000)	27	30	33	mA
$I_{BL_ (DATA29)}$	BL1-BL8 Current	Address 03h Data=FD (1111 1101)	1.75	1.94	2.13	mA
$V_{BL_ (TH)}$	BL1-BL8 Charge Pump Transition Threshold	Address 03h Data=E0 (1110 0000)		180		mV
$I_{AUX[1/2](MAX)}$	AUX Maximum Current	Address 05h Data=E0 (1110 0000) Address 06h Data=E0 (1110 0000)	54	60	66	mA
$I_{AUX[1/2](DATA13)}$	AUX Current	Address 05h Data=AC (1010 1100) Address 06h Data=AC (1010 1100)		18.4		mA
$\frac{\Delta I_{(AUX[1/2])}}{I_{AUX(AVG)}}$	AUX1 AUX2 Current Matching ²	Address 05h Data=E0 (1110 0000) Address 06h Data=E0 (1110 0000)			5	%

1. The AAT2862 is guaranteed to meet performance specifications over the $-40^{\circ}C$ to $+85^{\circ}C$ operating temperature range and is assured by design, characterization, and correlation with statistical process controls.

2. Current matching is defined as the deviation of any sink current from the average of all active channels.

Electrical Characteristics¹

$V_{IN} = 3.6V$; $C_{IN} = C_{OUT} = 2.2\mu F$; $C_1 = C_2 = 1\mu F$; $T_A = -40^\circ C$ to $+85^\circ C$, unless otherwise noted. Typical values are $T_A = 25^\circ C$.

Symbol	Description	Conditions	Min	Typ	Max	Units
Linear Regulators						
$\frac{\Delta V_{LDO[A/B/C/D]}}{V_{LDO[A/B/C/D]}}$	LDOA, LDOB, LDOC, LDOD Output Voltage Tolerance	$I_{OUT} = 1mA$ to $200mA$; $T_A = 25^\circ C$	-1.5		1.5	%
		$I_{OUT} = 1mA$ to $200mA$; $T_A = -40^\circ C$ to $+85^\circ C$	-3.0		3.0	%
$I_{LDO[A/B/C/D](MAX)}$	LDOA, LDOB, LDOC, LDOD Maximum Load Current		200			mA
$V_{LDO[A/B/C/D](DO)}$	LDOA, LDOB, LDOC, LDOD Dropout Voltage ²	$V_{LDO[A/B/C/D]} \geq 3.0V$; $I_{OUT} = 150mA$		75	200	mV
$\frac{\Delta V_{LDO}}{V_{LDO} * \Delta V_{IN}}$	LDOA, LDOB, LDOC, LDOD Line Regulation	$V_{LDO} = (V_{OUT[A/B/C/D]} + 1V)$ to $5V$		0.09		%/V
$PSRR_{[A/B/C/D]}$	LDOA, LDOB, LDOC, LDOD Power Supply Rejection Ratio	$I_{LDO[A/B/C/D]} = 10mA$, $1kHz$		50		dB
R_{OUT_DCHG}	LDOA, LDOB, LDOC, LDOD Auto-Discharge Resistance			20		Ω
I²C Logic and Control Interface						
V_{IL}	SDA, SCL, EN Input Low Threshold	$2.7V \leq V_{IN} \leq 5.5V$			0.4	V
V_{IH}	SDA, SCL, EN Input High Threshold	$2.7V \leq V_{IN} \leq 5.5V$	1.4			V
V_{OL}	SDA Output Low Voltage	$I_{PULLUP} = 3mA$			0.4	V
I_{IN}	SDA, SCL, EN Input Leakage Current	$V_{SDA} = V_{SCL} = V_{LED_SEL} = V_{LDO_SEL} = IN = 5V$	-1		1	μA
f_{SCL}	SCL Clock Frequency		0		400	kHz
t_{LOW}	SCL Clock Low Period		1.3			μs
t_{HIGH}	SCL Clock High Period		0.6			μs
t_{HD_STA}	Hold Time START Condition		0.6			μs
t_{SU_STA}	Setup Time for Repeat START		0.6			μs
t_{SU_DAT}	SDA Data Setup Time		100			ns
t_{HD_DAT}	SDA Data HOLD Time		0		0.9	μs
t_{SU_STO}	Setup Time for STOP Condition		0.6			μs
t_{BUF}	Bus Free Time Between STOP and START Conditions		1.3			μs

1. The AAT2862 is guaranteed to meet performance specifications over the $-40^\circ C$ to $+85^\circ C$ operating temperature range and is assured by design, characterization, and correlation with statistical process controls.

2. $V_{DO[A/B/C/D]}$ is defined as $V_{IN} - LDO[A/B/C/D]$ when $LDO[A/B/C/D]$ is 98% of nominal.

I²C Interface Timing Details

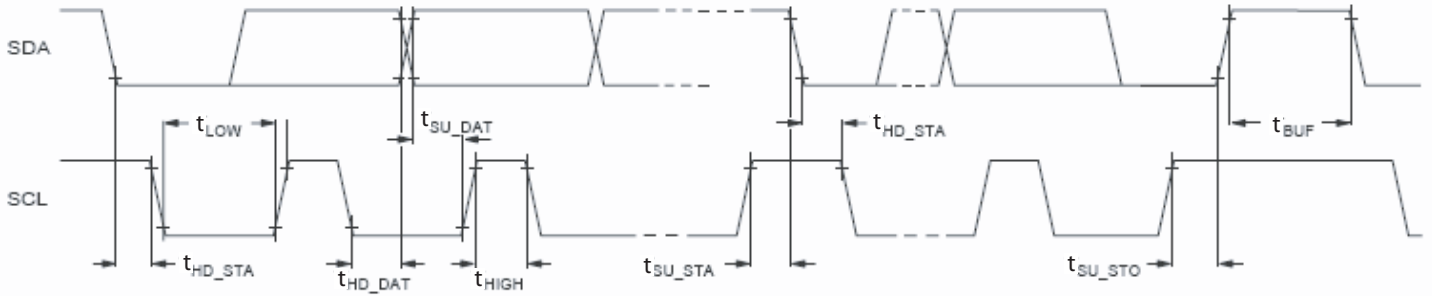

Typical Characteristics

Backlight Efficiency vs. Input Voltage

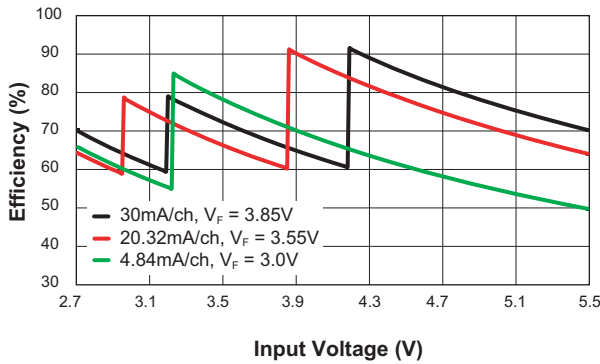

Backlight Current Matching vs. Temperature
($V_{IN} = 3.6V$; 30mA/ch)

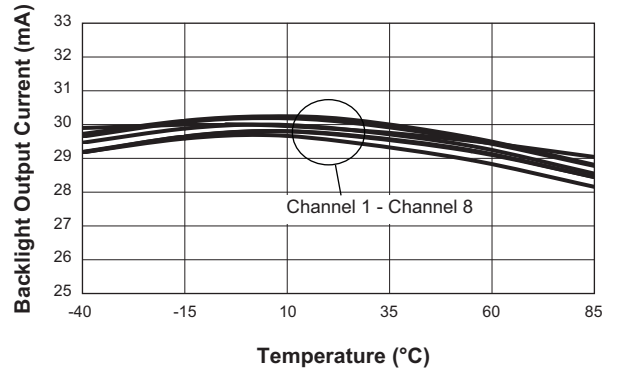

Charge Pump Output Turn On Characteristic
($V_{IN} = 3.6V$; $I_{LED} = 0mA$; $C_{OUT} = 2.2\mu F$)

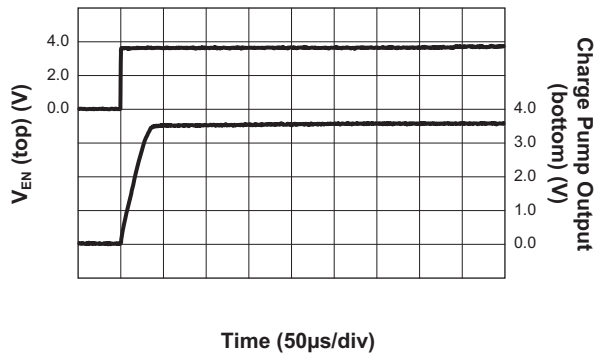

Turn On to 1x Mode Backlight
($V_{IN} = 4.5V$; 30mA/ch)

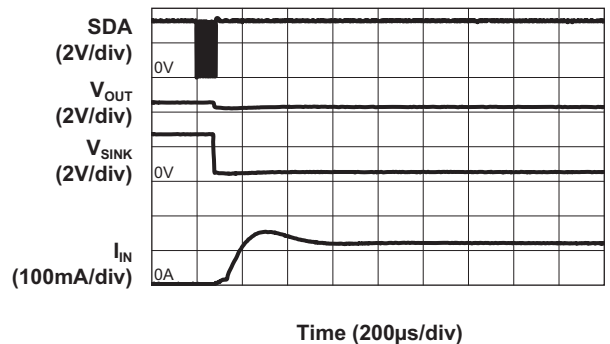

Turn On to 1.5x Mode Backlight
($V_{IN} = 3.5V$; 30mA/ch)

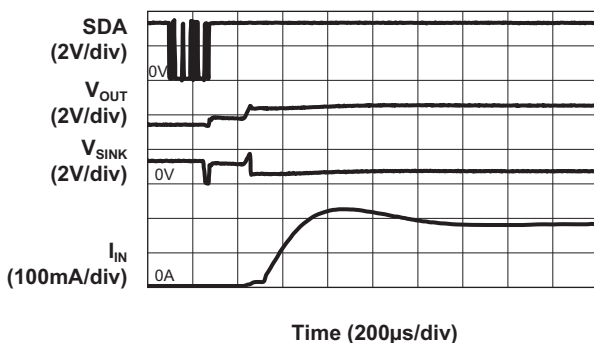

Turn On to 2x Mode Backlight
($V_{IN} = 3.2V$; 30mA/ch)

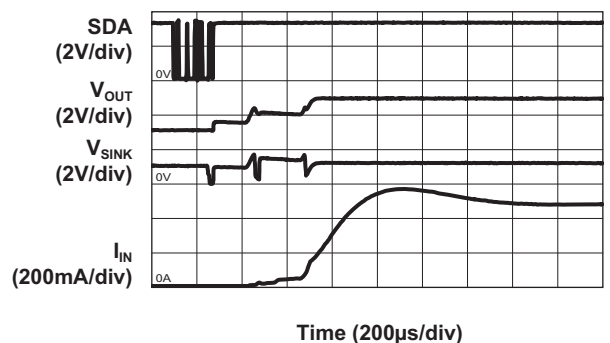

Typical Characteristics

Turn Off from 1.5x Mode Backlight
($V_{IN} = 3.5V$; 30mA/ch)

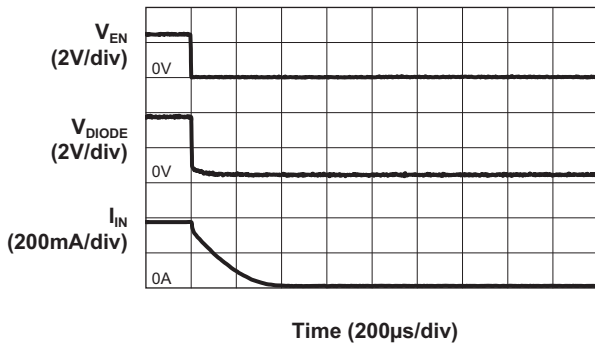

Operating Characteristic
($V_{IN} = 3.3V$; 30mA/ch Backlight; 1.5x Mode;
 $C_{OUT} = 2.2\mu F$; $f_{OSC} = 1.2MHz$)

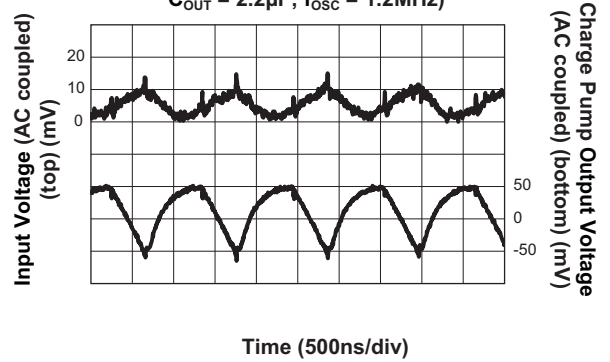

Operating Characteristic
($V_{IN} = 3.0V$; 30mA/ch Backlight; 2x Mode;
 $C_{OUT} = 2.2\mu F$; $f_{OSC} = 1.2MHz$)

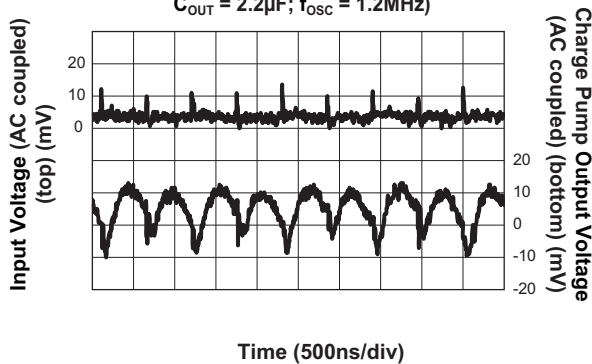

LDOA/B/C/D Output Voltage vs. Temperature
($V_{IN} = 3.6V$; $I_{LDO} = 0mA$)

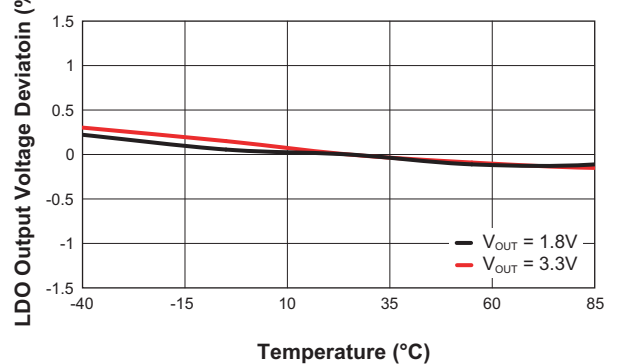

LDO A/B/C/D Load Regulation
($V_{IN} = 3.6V$)

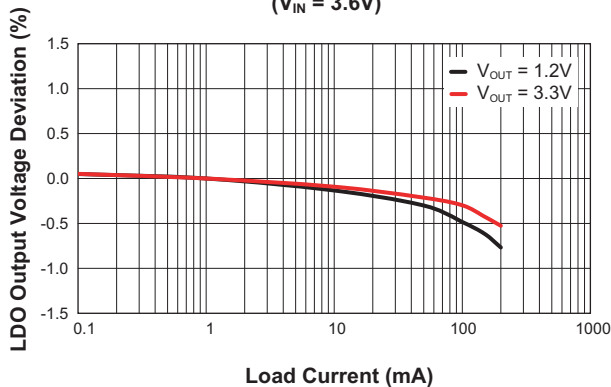

LDO A/B/C/D Line Regulation
($I_{LDO} = 10mA$)

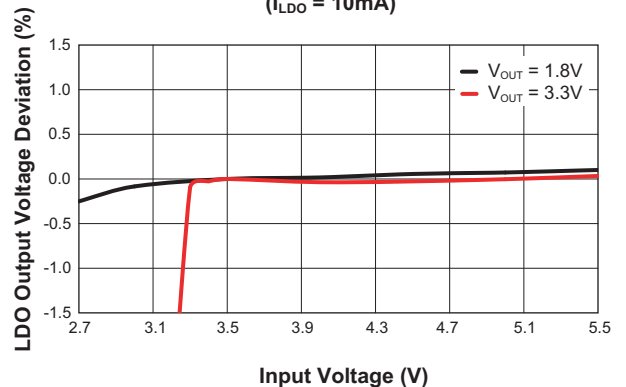

Typical Characteristics

LDO A/B/C/D Load Transient Response

($I_{LDO} = 10\text{mA}$ to 200mA ; $V_{IN} = 3.6\text{V}$; $V_{OUT} = 1.8\text{V}$; $C_{LDO} = 2.2\mu\text{F}$)

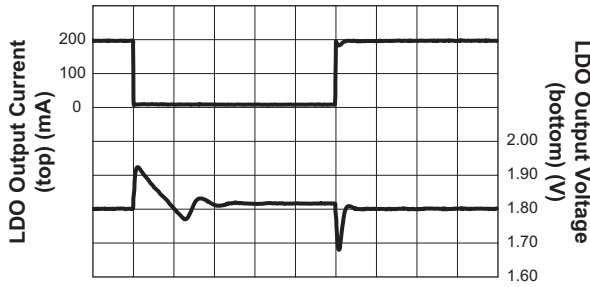

Time (20µs/div)

LDO A/B/C/D Line Transient Response

($V_{IN} = 3.6\text{V}$ to 4.2V ; $I_{LDO} = 10\text{mA}$; $V_{OUT} = 1.8\text{V}$; $C_{LDO} = 2.2\mu\text{F}$)

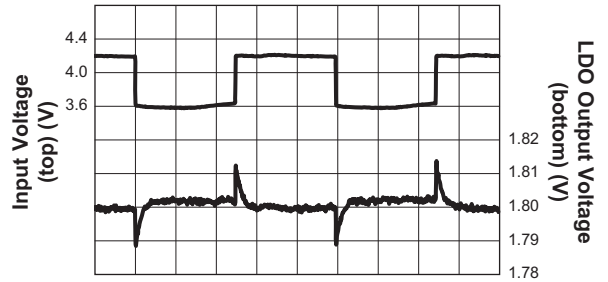

Time (1ms/div)

LDO A/B/C/D Turn On Characteristic

($V_{IN} = 3.6\text{V}$; $V_{OUT} = 1.8\text{V}$; $C_{LDO} = 2.2\mu\text{F}$)

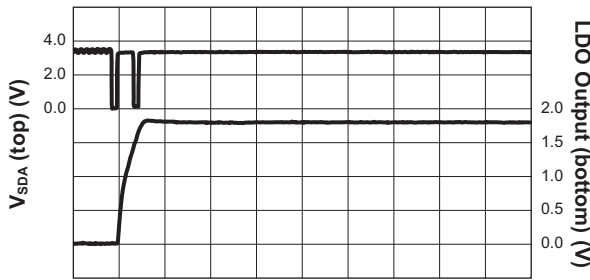

Time (20µs/div)

LDO A/B/C/D Turn On Characteristic

($V_{IN} = 3.6\text{V}$; $V_{OUT} = 3.3\text{V}$; $C_{LDO} = 2.2\mu\text{F}$)

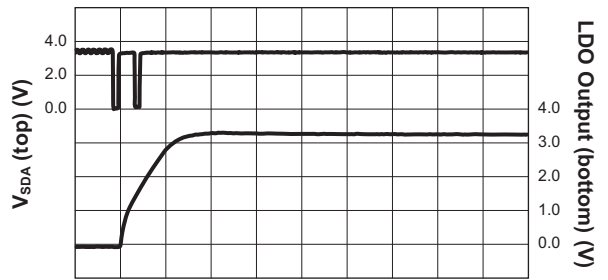

Time (20µs/div)

EN, SDA, SCL Input High Threshold Voltage vs. Input Voltage

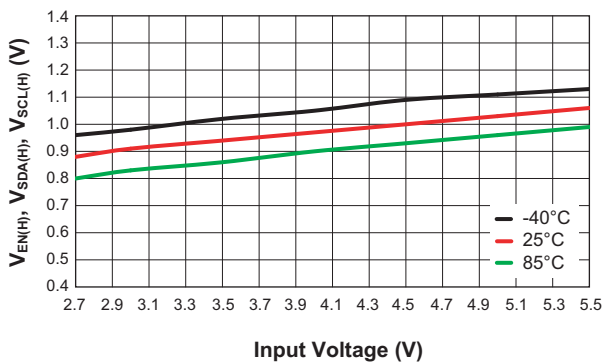

EN, SDA, SCL Input Low Threshold Voltage vs. Input Voltage

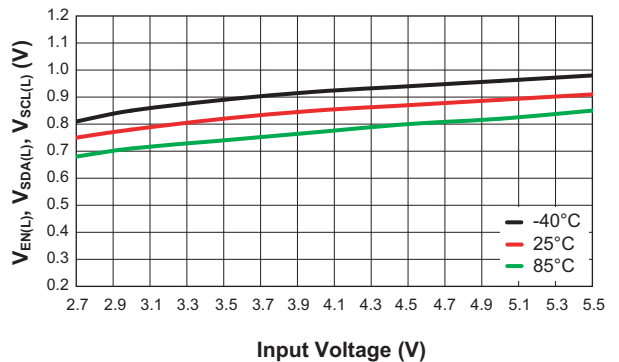

Functional Block Diagram

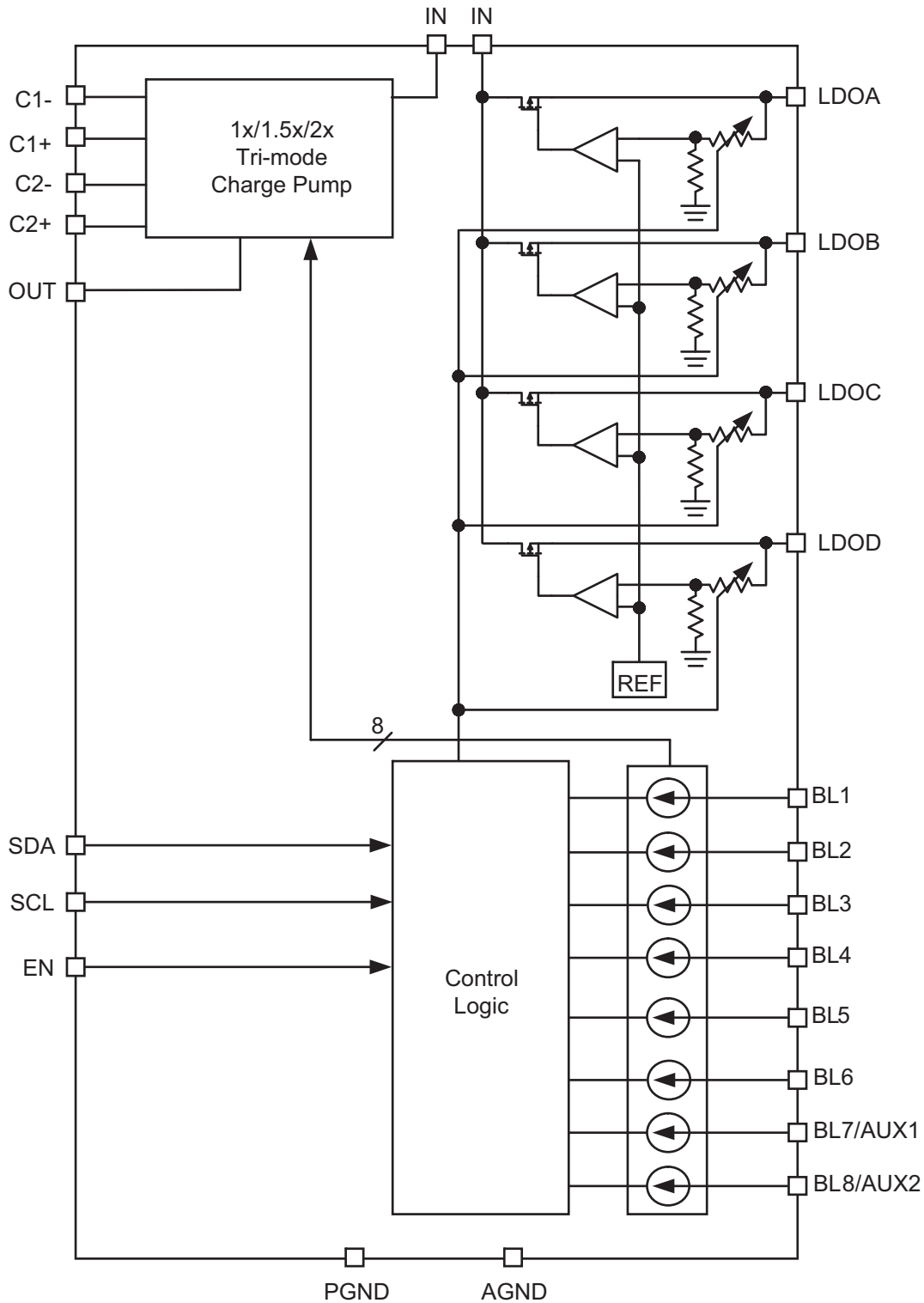

Functional Description

The AAT2862 is a highly integrated backlight driver with four LDO regulators. The charge pump LED driver powers the backlight LEDs from the 2.7V to 5.5V input voltage. The LDO regulators get their power from the same input and produce regulated output voltage between 1.2V and 3.3V. Control of the LEDs and the LDO output voltage is through an I²C serial interface for easy programming.

LED Drivers

The AAT2862 drives up to eight backlight LEDs up to 30mA each. The LEDs are driven from a charge pump to insure that constant current is maintained over the entire battery voltage range. The charge pump automatically switches from 1x, to 1.5x, to 2x modes and back to maintain the LED current while minimizing power loss for high efficiency. The charge pump operates at the high 1MHz switching frequency allowing the use of small 1μF ceramic capacitors.

Depending on the battery voltage and LED forward voltage, the charge pump drives the LEDs directly from the input voltage (1x or bypass mode) or steps up the input voltage by a factor of 1.5 (1.5x mode) or 2 (2x mode). The charge pump requires only two tiny 2.2μF ceramic capacitors, making a more compact solution than an inductor-based step-up converter solution. Each individual LED is driven by a current sink to GND, allowing individual current control with high accuracy over a wide range of input voltages and LED forward voltages while maintaining high efficiency.

The charge pump is controlled by the voltage across the LED current sinks. When any one of the active backlight current sink voltages drops below 180mV, the charge pump goes to the next higher mode (from 1x to 1.5x or from 1.5x to 2x mode) to maintain sufficient LED voltage for constant LED current. The AAT2862 continuously monitors the LED forward voltages and uses the input voltage to determine when to reduce the charge pump mode for better efficiency. There is also a 300mV mode-transition hysteresis that prevents the charge pump from oscillating between modes.

LED Current Control

The eight backlight LED channels are programmed through the I²C serial interface and can be set between 0.5 and 30mA in ~1mA steps. The currents match to within typically 3%. There are fade-in and fade-out timers that can be programmed through the interface as well.

See the "I²C Serial Interface" section for more information on setting the LED currents.

LDO Regulators

The AAT2862 includes four low dropout (LDO) linear regulators. These regulators are powered from the battery and produce a fixed output voltage set through the I²C serial interface. The output voltages can be programmed to one of 16 output voltages between 1.2V and 3.3V. The LDOs can also be turned on/off through the I²C serial interface.

The LDO regulators require only a small 2.2μF ceramic output capacitor for stability. If improved load transient response is required, larger-valued capacitors can be used without stability degradation.

I²C Serial Interface

The AAT2862 uses an I²C serial interface to set the LED currents, the LDO's output voltages, and to turn on/off all LDOs, as well as other housekeeping functions. The I²C interface takes input from a master device while the AAT2862 acts as a target to the master.

The I²C protocol uses two open-drain inputs; SDA (serial data line) and SCL (serial clock line). Both inputs require an external pull up resistor, typically to the input voltage. The I²C protocol is bidirectional and allows target devices and masters to both read and write to the bus. The AAT2862 only supports the write protocol; therefore, the Read/Write bit must always be set to "0". The timing diagram in Figure 1 shows the typical transmission protocol.

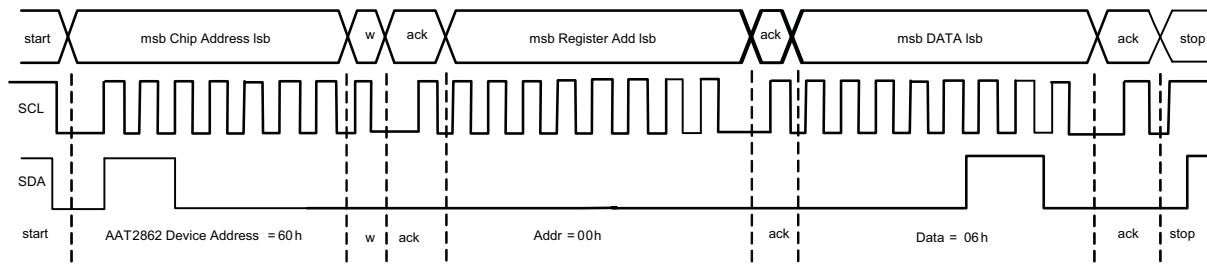

Figure 1: Typical I²C Timing Diagram.

I²C Serial Interface Protocol

The I²C serial interface protocol is shown in Figure 1. Devices on the bus can be either master or target devices. Both master and target devices can both send and receive data over the bus, with the difference being that the master device controls all communication on the bus. The AAT2862 acts as a target device on the bus and is only capable of receiving data and does not transmit data over the bus.

The I²C communications begin with the master making a START condition. Next, the master transmits the 7-bit device address and a Read/Write bit. Each target device on the bus has a unique address. The AAT2862 device address is 60h.

If the address transmitted by the master matches the device address, the target device transmits an Acknowledge (ACK) signal to indicate that it is ready to receive data. Since the AAT2862 only reads from the master, the Read/Write bit must be set to "0". Next, the master transmits the 8-bit register address, and the target device transmits an ACK to indicate that it received the register address. Next, the master transmits the 8-bit data word, and again the target device transmits an ACK indicating that it received the data. This process continues until the master is finished writing to the target device, at which time the master generates a STOP condition.

START and STOP Conditions

START and STOP conditions are always generated by the master. Prior to initiating a START, both the SDA and SCL pin are inactive and are pulled high through external pull-up resistors. As shown in Figure 1, a START condition is when the master pulls the SDA line low and, after the start condition hold time (t_{HT_STA}), the master strobes the SCL line low. A START condition acts as a signal to devices on the bus that the device producing the START condition is active and will be communicating on the bus.

A STOP condition, as shown in Figure 1, is when SCL changes from low to high followed after the STOP condition setup time (t_{SU_STO}), by an SDA low-to-high transition. The master does not issue an ACK and releases SCL and SDA.

Transferring Data

Addresses and data are sent with the most significant bit first transmitted and the least significant bit transmitted last. After each address or data transmission, the target device transmits an ACK signal to indicate that it has received the transmission. The ACK signal is generated by the target after the master releases the SDA data line by driving SDA low.

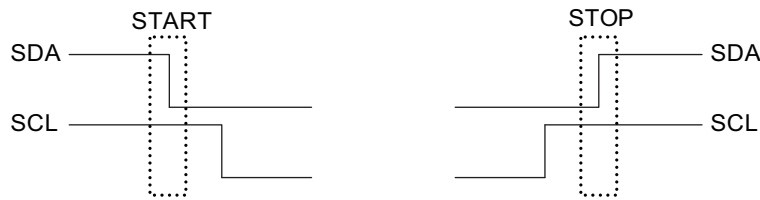

Figure 2: I²C STOP and START Conditions;
START: A High "1" to Low "0" Transition on the SDA Line While SCL is High "1"
STOP: A Low "0" to High "1" Transition on the SDA Line While SCL is High "1".

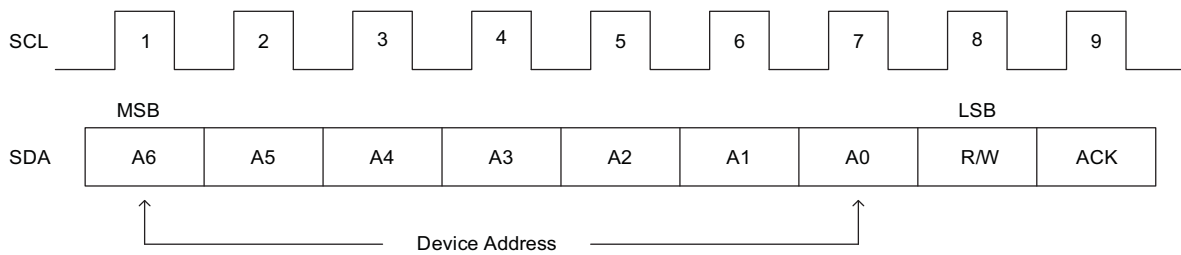

Figure 3: I²C Address Bit Map;
7-bit Slave Address (A6-A0), 1-bit Read/Write (R/W), 1-bit Acknowledge (ACK).

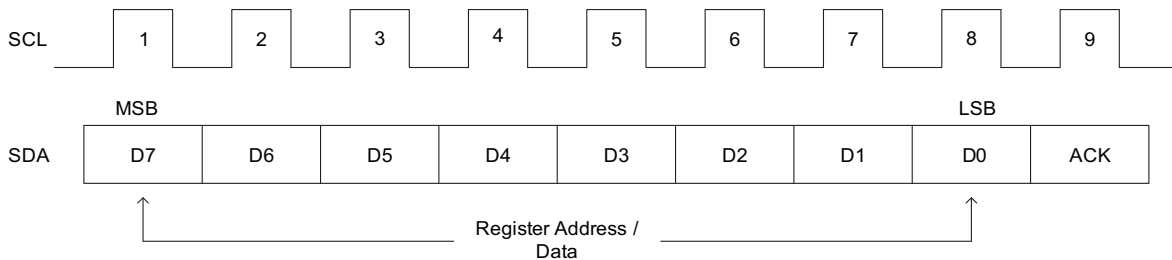

Figure 4: I²C Register Address and Data Bit Map;
8-bit Data (D7-D0), 1-bit Acknowledge (ACK).

Applications Information

I²C Serial Programmed Registers

The AAT2862 I²C programmable registers are listed in Table 1. There are eight registers, five for the backlight LED control, and three to control the four LDOs.

All backlight channels can be easily configured in many different ways through the I²C interface. The default assignment for the drivers is four backlight for Main, two backlight for Sub, and two extra that can be applied to Main, Sub, or Auxiliary. All eight backlight channels can be driven to the same current level by writing the MEQS = 1 bit in REG3. The Main and Sub backlights can be programmed independently to one of 32 levels described in Table 2.

Backlight Control Registers

The AAT2862 has five backlight registers:

- REG3 (I²C address 03h) controls Main backlight.
- REG4 (I²C address 04h) controls Sub backlight.
- REG5 (I²C address 05h) controls auxiliary Aux1 backlight.
- REG6 (I²C address 06h) controls auxiliary Aux2 backlight.
- REG7 (I²C address 07h) controls backlight fade-in and fade-out function.

Register		Functional Description	Data Bit7	Data Bit6	Data Bit5	Data Bit4	Data Bit3	Data Bit2	Data Bit1	Data Bit0
Number	Hex Address									
REG0	00h	LDO A & B Output Voltage Control	LDOA[3]	LDOA[2]	LDOA[1]	LDOA[0]	LDOB[3]	LDOB[2]	LDOB[1]	LDOB[0]
REG1	01h	LDO C & D Output Voltage Control	LDOC[3]	LDOC[2]	LDOC[1]	LDOC[0]	LDOD[3]	LDOD[2]	LDOD[1]	LDOD[0]
REG2	02h	LDO EN control	X	X	X	X	ENLDO_D	ENLDO_C	ENLDO_B	ENLDO_A
REG3	03h	Backlight Current Control MAIN	MEQS	DISABLE FADE_MAIN	MAIN_ON	BLM[4]	BLM[3]	BLM[2]	BLM[1]	BLM[0]
REG4	04h	Backlight Current Control SUB	X	DISABLE FADE_SUB	SUB_ON	BLS[4]	BLS[3]	BLS[2]	BLS[1]	BLS[0]
REG5	05h	Backlight Current Control AUX1	AUX1[1]	AUX1[0]	AUX1_ON	BLA1[4]	BLA1[3]	BLA1[2]	BLA1[1]	BLA1[0]
REG6	06h	Backlight Current Control AUX2	AUX2[2]	AUX2[0]	AUX2_ON	BLA2[4]	BLA2[3]	BLA2[2]	BLA2[1]	BLA2[0]
REG7	07h	Backlight Fade Control	X	X	FADE_TIME[1]	FADE_TIME[0]	FADE_MAIN	FADE_SUB	FLOOR[1]	FLOOR[0]

Table 1: AAT2862 Configuration/Control Register Allocation (“X” = “Reserved”).

Data Bit4	Data Bit3	Data Bit2	Data Bit1	Data Bit0	LED Current (mA)
BLM[4]	BLM[3]	BLM[2]	BLM[1]	BLM[0]	REG3
BLS[4]	BLS[3]	BLS[2]	BLS[1]	BLS[0]	REG4
BLA1[4]	BLA1[3]	BLA1[2]	BLA1[1]	BLA1[0]	REG5
BLA2[4]	BLA2[3]	BLA2[2]	BLA2[1]	BLA2[0]	REG6
0	0	0	0	0	30*
0	0	0	0	1	29.03
0	0	0	1	0	28.06
0	0	0	1	1	27.10
0	0	1	0	0	26.13
0	0	1	0	1	25.16
0	0	1	1	0	24.19
0	0	1	1	1	23.23
0	1	0	0	0	22.26
0	1	0	0	1	21.29
0	1	0	1	0	20.32
0	1	0	1	1	19.35
0	1	1	0	0	18.38
0	1	1	0	1	17.42
0	1	1	1	0	16.45
0	1	1	1	1	15.48
1	0	0	0	0	14.52
1	0	0	0	1	13.55
1	0	0	1	0	12.58
1	0	0	1	1	11.61
1	0	1	0	0	10.65
1	0	1	0	1	9.68
1	0	1	1	0	8.71
1	0	1	1	1	7.74
1	1	0	0	0	6.77
1	1	0	0	1	5.81
1	1	0	1	0	4.84
1	1	0	1	1	3.87
1	1	1	0	0	2.9
1	1	1	0	1	1.94
1	1	1	1	0	0.97
1	1	1	1	1	0.48

Table 2: Main/Sub/Aux Backlight LED Current - BLM/BLS/BLA1,2[4:0].

Table 3 describes the floor current per channel for the fade-in and fade-out functions. In fade-out sequence floor will be the final current that will continue to be present until the Main, Sub or Aux1,2 channels are disabled by writing MAIN_ON = 0 to REG3, SUB_ON = 0 to REG4, A1_ON = 0 to REG5, and/or A2_ON = 0 to REG6. In fade-in sequence floor is the direct current all chan-

nels will be turned on by writing MAIN_ON = 1 to REG3, SUB_ON = 1 to REG4, A1_ON = 1 to REG5, and/or A2_ON = 1 to REG6.

Fade-out can be initiated only after the fade in sequence has been programmed first by writing FADE_MAIN = 1 and/or FADE_SUB = 1 as is shown in Table 4.

*Denotes default (power-on-reset) value.

Data Bit1	Data Bit0	Fade In and Out Current Level (mA)
FLOOR[1]	FLOOR[0]	REG7
0*	0*	0.48*
0	1	0.97
1	0	1.94
1	1	2.90

Table 3: Main/Sub LED Current Fade In and Out Level Control.

Data Bit3	Data Bit2	Fade In and Out Control	
		REG7	
FADE_MAIN	FADE_SUB	Main	Sub
0*	0*	Fade Out*	Fade Out*
0	1	Fade Out	Fade In
1	0	Fade In	Fade Out
1	1	Fade In	Fade In

Table 4: Main/Sub LED Current Fade In and Out Control.

Data Bit5 of REG3, REG4, REG5 and REG6 controls the turn on and off of the Main, Sub, Aux1 and Aux2 channels according to Table 5. Both Aux1 and Aux2 channels are considered part of the Sub backlight channels unless explicitly turned on as part of the Main backlight or independently.

Data Bit5	Backlight Channel ON/OFF
MAIN_ON	REG3
SUB_ON	REG4
AUX1_ON	REG5
AUX2_ON	REG6
0*	OFF*
1	ON

Table 5: Main/Sub/Aux1/Aux2 LED Current ON/OFF Control.

Data Bit6 of REG3 and REG4 enables the fade in and out control of the Main and Sub channels. Fade function is enabled by default and can be explicitly disabled by writing DISABLE_FADE_MAIN = 1 and/or DISABLE_FADE_SUB = 1 as shown in Table 6.

Data Bit6	Backlight Channel Fade In and Out Enable/Disable
DISABLE_FADE_MAIN	REG3
DISABLE_FADE_SUB	REG4
0*	Enable*
1	Disable

Table 6: Main/Sub Current Fade ON/OFF Control.

Data Bit7=1 of REG3 programs all Sub channels as Main backlight as described in Table 7. If the Main fade-in or fade-out function is enabled; all eight Main and Sub channels will be faded-in or out simultaneously.

Data Bit7	MAIN Equal SUB (MEQS)
MEQS	REG3
0*	False*
1	True

Table 7: Main/Sub Current Fade ON/OFF Control.

Data Bit4 and Data Bit5 of REG7 control the duration of the fade-in/out function. The default timing is 850ms with options for 650ms and 425ms according to Table 8. The charge pump oscillator frequency is related to the fade-in/out timing as follows:

For the 850ms fade-in/out timer, typical $f_{osc} = 600kHz$
 For the 650ms fade-in/out timer, typical $f_{osc} = 800kHz$
 For the 425ms fade-in/out timer, typical $f_{osc} = 1.2MHz$ respectively.

Data Bit5	Data Bit4	Fade In and Out Timing (ms)
FADE_TIME[1]	FADE_TIME[0]	
0*	0*	850*
0	1	650
1	0	425
1	1	850

Table 8: Main/Sub LED Current Fade In and Out Timing

*Denotes default (power-on-reset) value.

Examples of Fade-Out Programming

Main Only (Sub is OFF):

Address 03h, Data 40: Disable fade
 Address 07h, Data 08: Fade-in is programmed
 Address 03h, Data 6F: Turn on directly to 15.48mA/ch
 Address 03h, Data 20: Re-enable fade
 Address 07h, Data 00: Fade-out to 0.48mA/ch

Sub Only (Main is OFF):

Address 04h, Data 40: Disable fade
 Address 07h, Data 04: Fade-in is programmed
 Address 04h, Data 6F: Turn on directly to 15.48mA/ch
 Address 04h, Data 2F: Enable fade
 Address 07h, Data 02: Fade-out to 1.94mA/ch

Main and Sub (as shown in Figure 5):

Address 03h, Data C0: Disable fade
 Address 07h, Data 0C: Fade-in is programmed
 Address 03h, Data 60: Turn on directly to 30mA/ch
 Address 03h, Data 20: Enable fade
 Address 07h, Data 03: Fade-out to 2.90mA/ch

Examples of Fade-In/Out Programming

Main Only (Sub is OFF):

Address 03h, Data 20: Main backlight is turned on with 0.48mA/ch
 Address 07h, Data 08: Fade-in to 30mA/ch
 Address 07h, Data 03: Fade-out to 2.90mA/ch

Sub Only (Main is OFF):

Address 07h, Data 02: Fade-in is programmed to 1.94mA/ch
 Address 04h, Data 2E: Sub backlight is turned on with 1.94mA/ch
 Address 07h, Data 04: Fade-in to 16.45mA/ch
 Address 07h, Data 02: Fade-out to 1.94mA/ch

Main and Sub (as shown in Figure 6):

Address 07h, Data 01: Fade-in is programmed to 0.97mA/ch
 Address 03h, Data AA: Main and Sub backlight is turned on with 0.97mA/ch
 Address 07h, Data 0C: Fade-in to 20.32mA/ch
 Address 07h, Data 01: Fade-out to 0.97mA/ch

Main and Sub Fade Out Only

Max. 30mA/ch to 2.90mA/ch

I2C Sequence:
 AAT2862 Chip Address 60h

REG3 Address 03h, Data C0(0100 0000): Disable fade function
 REG7 Address 07h, Data 0C(0000 1100): Fade-in is programmed
 REG3 Address 03h, Data 60(0110 0000): Main/Sub is turned on with 30mA/ch

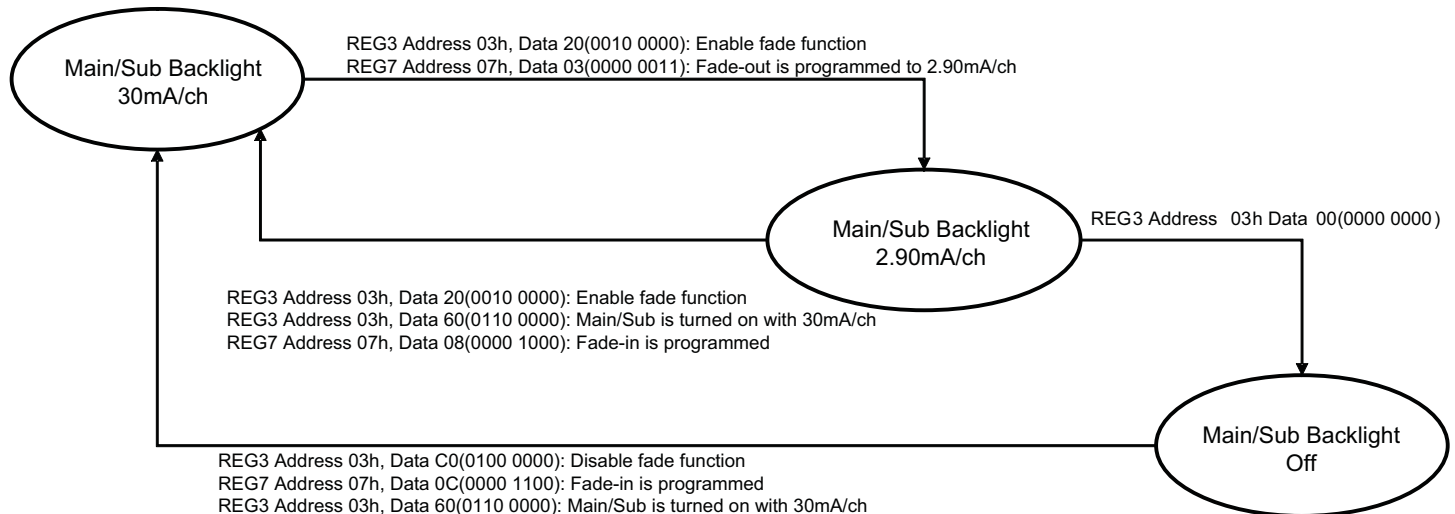

Figure 5: Example of AAT2862 Fade Out Programming.

Main and Sub Fade In/Out

Max. 20.32mA/ch to 0.97mA/ch

I2C Sequence:
AAT2862 Chip Address 60h

REG7 Address 07h, Data 01(0000 0001): Fade-in is programmed as 0.97mA/ch
REG3 Address 03h, Data AA(1010 1010): Main/Sub backlight is turned on with 0.97mA/ch
REG7 Address 07h, Data 0C(0000 1100): Fade-in programmed to 20.32mA/ch

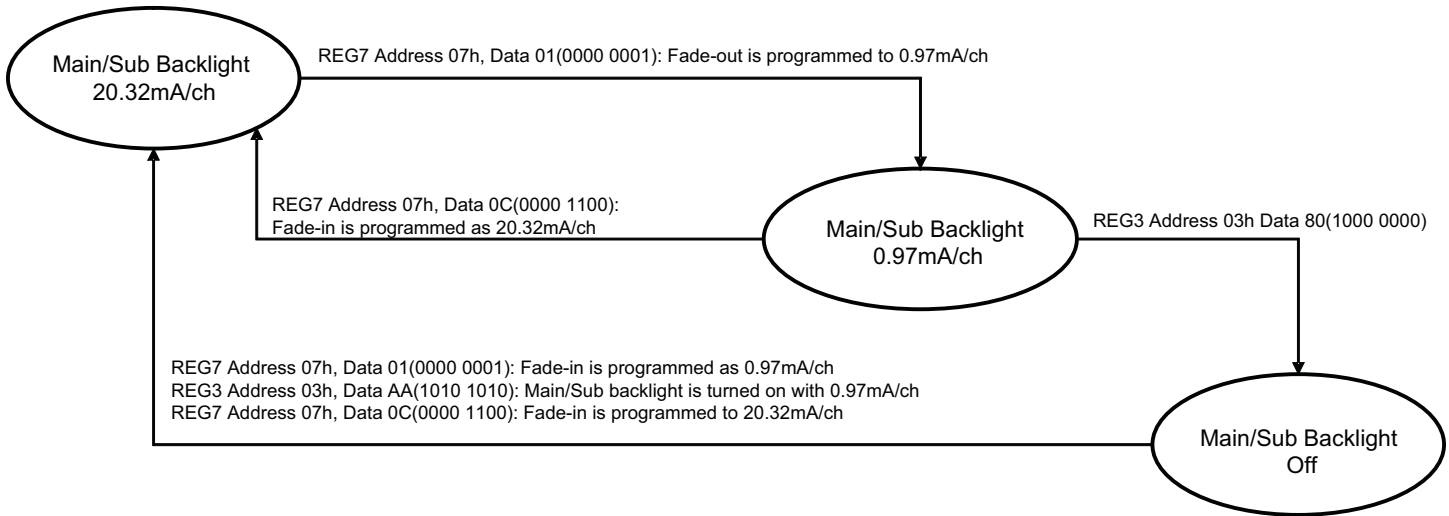

Figure 6: Example of AAT2862 Fade In/Out Programming.

LDO Control Registers

The four LDO regulators have three dedicated control registers:

- REG0 (I²C address 00h) and REG1 (I²C address 01h) set the output voltages of LDOA/B/C/D to one of 16 pre-set values according to Table 9 and Table 10.
- REG2 (I²C address 02h) controls turning on/off of LDOA/B/C/D regulators according to Table 11.

Data Bit7	Data Bit6	Data Bit5	Data Bit4	LDO $V_{LDO[A/C]}$ (V)
LDOA[3]	LDOA[2]	LDOA[1]	LDOA[0]	REG0
LDOC[3]	LDOC[2]	LDOC[1]	LDOC[0]	REG1
0*	0*	0*	0*	1.2*
0	0	0	1	1.3
0	0	1	0	1.5
0	0	1	1	1.6
0	1	0	0	1.8
0	1	0	1	2.0
0	1	1	0	2.2
0	1	1	1	2.5
1	0	0	0	2.6
1	0	0	1	2.7
1	0	1	0	2.8
1	0	1	1	2.9
1	1	0	0	3.0
1	1	0	1	3.1
1	1	1	0	3.2
1	1	1	1	3.3

Data Bit3	Data Bit2	Data Bit1	Data Bit0	LDO $V_{LDO[B/D]}$ (V)
LDOB[3]	LDOB[2]	LDOB[1]	LDOB[0]	REG0
LDOD[3]	LDOD[2]	LDOD[1]	LDOD[0]	REG1
0*	0*	0*	0*	1.2*
0	0	0	1	1.3
0	0	1	0	1.5
0	0	1	1	1.6
0	1	0	0	1.8
0	1	0	1	2.0
0	1	1	0	2.2
0	1	1	1	2.5
1	0	0	0	2.6
1	0	0	1	2.7
1	0	1	0	2.8
1	0	1	1	2.9
1	1	0	0	3.0
1	1	0	1	3.1
1	1	1	0	3.2
1	1	1	1	3.3

Table 9: LDOA/LDOC Output Voltage Control Data.

Table 10: LDOB/LDOD Output Voltage Control Data.

Data Bit3	Data Bit2	Data Bit1	Data Bit0	LDOD Output	LDOC Output	LDOB Output	LDOA Output
ENLDO_D	ENLDO_C	ENLDO_B	ENLDO_A				
0*	0*	0*	0*	Off*	Off*	Off*	Off*
0	0	0	1	Off	Off	Off	On
0	0	1	0	Off	Off	On	Off
0	0	1	1	Off	Off	On	On
0	1	0	0	Off	On	Off	Off
0	1	0	1	Off	On	Off	On
0	1	1	0	Off	On	On	Off
0	1	1	1	Off	On	On	On
1	0	0	0	On	Off	Off	Off
1	0	0	1	On	Off	Off	On
1	0	1	0	On	Off	On	Off
1	0	1	1	On	Off	On	On
1	1	0	0	On	On	Off	Off
1	1	0	1	On	On	Off	On
1	1	1	0	On	On	On	Off
1	1	1	1	On	On	On	On

Table 11: LDOA/LDOB/LDOC/LDOD ON/OFF Control Data.

*Denotes default (power-on-reset) value.

Auxiliary Backlight Selection

Each of the auxiliary drivers (Aux1, Aux2) can also be programmed to one of the 32 levels described in Table 2. The auxiliary drivers can be driven independently, or combined with the main or sub by changing Data Bit6 and Data Bit7 in REG5 (I²C address 05h) and REG6 (I²C address 06h) according to Table 12. The auxiliary drivers can also be set to operate at twice their programmed current if AUX1[1] = 1 and AUX1[0] = 1 in REG5 and AUX2[1] = 1 and AUX2[0] = 1 in REG6.

Data Bit7	Data Bit6	Auxiliary Channel Assignment
AUX1[1]	AUX1[0]	REG5
AUX2[1]	AUX2[0]	REG6
0*	0*	I _{AUX1} = Sub* I _{AUX2} = Sub*
0	1	I _{AUX1} = Main I _{AUX2} = Main
1	0	I _{AUX1} = Aux1 I _{AUX2} = Aux2
1	1	I _{AUX1} = 2•Aux1 I _{AUX2} = 2•Aux2

Table 12: Auxiliary Channel Assignment.

LED Selection

The AAT2862 is specifically intended for driving white LEDs. However, the device design will allow the AAT2862 to drive most types of LEDs with forward voltage specifications ranging from 2.0V to 4.7V. LED applications may include mixed arrangements for display backlighting, color (RGB) LEDs, infrared (IR) diodes and any other load needing a constant current source generated from a varying input voltage. Since the D1 to D8 constant current sinks are matched with negligible voltage dependence, the constant current channels will be matched regardless of the specific LED forward voltage (V_F) levels.

The *low-dropout* current sinks in the AAT2862 maximize performance and make it capable of driving LEDs with high forward voltages. Multiple channels can be combined to obtain a higher LED drive current without complication.

Device Switching Noise Performance

The AAT2862 operates at three fixed frequencies, typically 600kHz, 800kHz, and 1.2MHz, in order to help control noise and limit harmonics that can interfere with the RF operation of cellular telephone handsets or other communication devices. Back-injected noise appearing on the input pin of the charge pump is 20mV peak-to-peak, typically ten times less than inductor-based DC/DC boost converter white LED backlight solutions. The AAT2862 soft-start feature prevents noise transient effects associated with in-rush currents during the start up of the charge pump circuit.

Power Efficiency and Device Evaluation

Charge-pump efficiency discussion in the following sections accounts only for the efficiency of the charge pump section itself. Due to the unique circuit architecture and design of the AAT2862, it is very difficult to measure efficiency in terms of a percent value comparing input power over output power.

Since the AAT2862 outputs are pure constant current sinks and typically drive individual loads, it is difficult to measure the output voltage for a given output (BL1 to BL8) to derive an overall output power measurement. For any given application, white LED forward voltage levels can differ, yet the output drive current will be maintained as a constant.

This makes quantifying output power a difficult task when taken in the context of comparing to other white LED driver circuit topologies. A better way to quantify total device efficiency is to observe the total input power to the device for a given LED current drive level. The *best* White LED driver for a given application should be based on trade-offs of size, external component count, reliability, operating range and total energy usage...*not just "% efficiency"*.

*Denotes default (power-on-reset) value.

ChargePump™**Backlight LED Driver and Multiple LDO Lighting Management Unit**

The AAT2862 efficiency may be quantified under very specific conditions and is dependent upon the input voltage versus the output voltage seen across the loads applied to outputs D1 through D8 for a given constant current setting. Depending on the combination of V_{IN} and voltages sensed at the current sinks, the device will operate in load switch mode. When any one of the voltages sensed at the current sinks nears dropout the device will operate in 1.5x or 2x charge pump mode. Each of these modes will yield different efficiency values. Refer to the following two sections for explanations of each operational mode.

1x Mode Efficiency

The AAT2862 1x mode is operational at all times and functions alone to enhance device power conversion efficiency when V_{IN} is greater than the voltage across the load. When in 1x mode, the voltage conversion efficiency is defined as output power divided by input power:

$$\eta = \frac{P_{OUT}}{P_{IN}}$$

The expression to define the ideal efficiency (η) can be rewritten as:

$$\eta = \frac{P_{OUT}}{P_{IN}} = \frac{V_{OUT} \cdot I_{OUT}}{V_{IN} \cdot I_{OUT}} = \frac{V_{OUT}}{V_{IN}}$$

-or-

$$\eta(\%) = 100 \left(\frac{V_{OUT}}{V_{IN}} \right)$$

1.5x/2x Charge Pump Mode Efficiency

The AAT2862 contains a fractional charge pump which will boost the input supply voltage in the event where V_{IN} is less than the voltage required to supply the output. The efficiency (η) can be simply defined as a linear voltage regulator with an effective output voltage that is equal to one and a half or two times the input voltage. Efficiency (η) for an ideal 1.5x charge pump can typically be expressed as the output power divided by the input power.

$$\eta = \frac{P_{OUT}}{P_{IN}}$$

In addition, with an ideal 1.5x charge pump, the output current may be expressed as 2/3 of the input current. The expression to define the ideal efficiency (η) can be rewritten as:

$$\eta = \frac{P_{OUT}}{P_{IN}} = \frac{V_{OUT} \cdot I_{OUT}}{V_{IN} \cdot 1.5I_{OUT}} = \frac{V_{OUT}}{1.5V_{IN}}$$

$$\eta(\%) = 100 \left(\frac{V_{OUT}}{1.5V_{IN}} \right)$$

For a charge pump with an output of 5V and a nominal input of 3.5V, the theoretical efficiency is 95%. Due to internal switching losses and IC quiescent current consumption, the actual efficiency can be measured at 93%. These figures are in close agreement for output load conditions from 1mA to 100mA. Efficiency will decrease substantially as load current drops below 1mA or when level of V_{IN} approaches V_{OUT} .

The same calculations apply for 2x mode where the output current then becomes 1/2 of the input current.

Capacitor Selection

Careful selection of the four external capacitors C_{IN} , C_1 , C_2 , and C_{OUT} is important because they will affect turn on time, output ripple and transient performance. Optimum performance will be obtained when low ESR (<100m Ω) ceramic capacitors are used. In general, low ESR may be defined as less than 100m Ω . A capacitor value of 1 μ F for all four capacitors is a good starting point when choosing capacitors. If the constant current sinks are only programmed for light current levels, then the capacitor size may be decreased.

Capacitor Characteristics

Ceramic composition capacitors are highly recommended over all other types of capacitors for use with the AAT2862. Ceramic capacitors offer many advantages over their tantalum and aluminum electrolytic counterparts. A ceramic capacitor typically has very low ESR, is lowest cost, has a smaller PCB footprint and is non-polarized. Low ESR ceramic capacitors help maximize charge pump transient response. Since ceramic capacitors are non-polarized, they are not prone to incorrect connection damage.

Equivalent Series Resistance (ESR)

ESR is an important characteristic to consider when selecting a capacitor. ESR is a resistance internal to a capacitor, which is caused by the leads, internal connections, size or area, material composition and ambient temperature. Capacitor ESR is typically measured in milliohms for ceramic capacitors and can range to more than several ohms for tantalum or aluminum electrolytic capacitors.

Ceramic Capacitor Materials

Ceramic capacitors less than 0.1µF are typically made from NPO or COG materials. NPO and COG materials typically have tight tolerance and are stable over temperature. Larger capacitor values are typically composed of X7R, X5R, Z5U or Y5V dielectric materials. Large ceramic capacitors, typically greater than 2.2µF are often available in low cost Y5V and Z5U dielectrics, but capacitors greater than 1µF are typically not required for AAT2862 applications.

Capacitor area is another contributor to ESR. Capacitors that are physically large will have a lower ESR when compared to an equivalent material smaller capacitor. These larger devices can improve circuit transient response when compared to an equal value capacitor in a smaller package size.

Evaluation Board User Interface

The user interface for the AAT2862 evaluation board is provided by three buttons and three connection terminals. The board is operated by supplying external power and pressing individual buttons or button combinations. Table 14 indicates the function of each button or button combination.

To power-on the evaluation board, connect a power supply or battery to the DC- and DC+ terminals. Close the board's supply connection by positioning the J1 jumper to the ON position. A red LED indicates that power is applied.

The evaluation board is made flexible so that the user can disconnect the data, clock and enable lines from the microcontroller and apply external signal sources by removing the jumpers from J2, J3 and/or J4. External enable signal must be applied to the ON pin of J4 terminal. External I²C clock SCL can be applied to J2 pin and data SDA to J3 pin.

When applying external enable signals, consideration must be given to the voltage levels. The externally applied voltages should not exceed the supply voltage that is applied to the IN pins of the device (DC+).

The LDO loads can be connected directly to the evaluation board. For adequate performance, be sure to connect the load between LDOA/LDOB/LDOC/LDOD and DC- as opposed to some other GND in the system.

Manufacturer	Part Number	Value	Voltage	Temp. Co.	Case
AVX	0603ZD105K	1µF	10	X5R	0603
	0603ZD225K	2.2µF	10		
TDK	C1608X5R1E105K	1µF	25	X5R	0603
	C1608X5R1C225K	2.2µF	16		
	C1608X5R1A475K	4.7µF	10		
Murata	GRM188R61C105K	1µF	16	X5R	0603
	GRM188R61A225K	2.2µF	10		
Taiyo Yuden	LMK107BJ475KA	4.7µF	10	X5R	0603

Table 13: Surface Mount Capacitors.

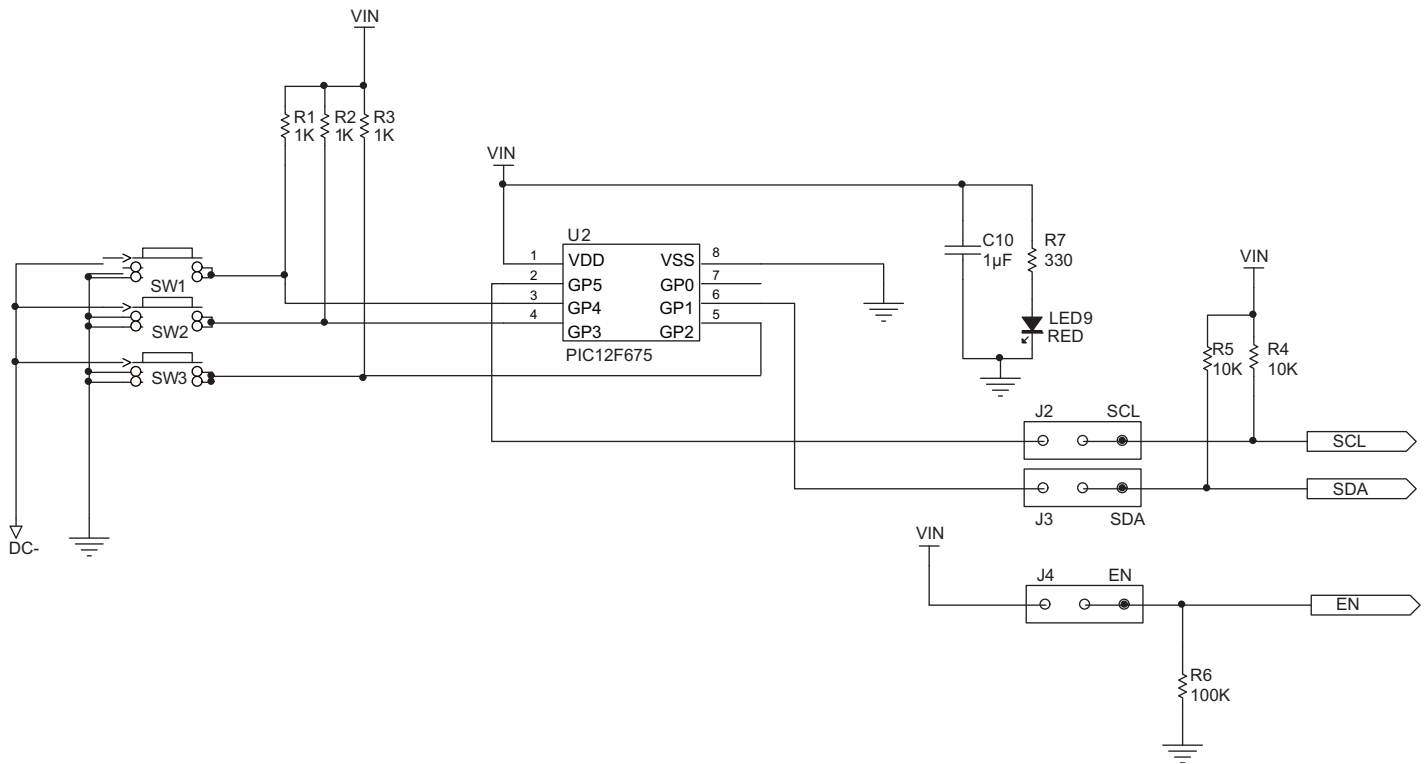

Figure 8: AAT2862 Evaluation Board Microcontroller Schematic.

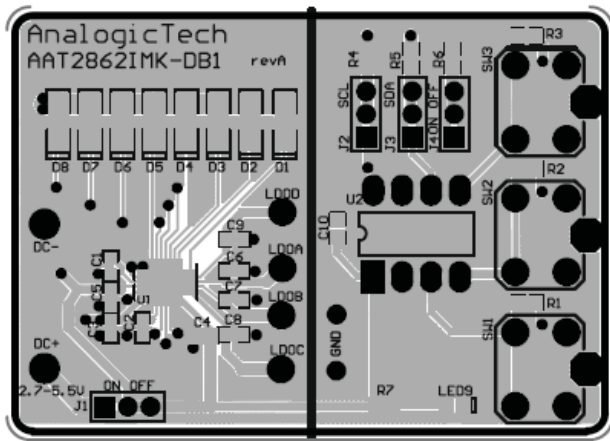

Figure 9: AAT2862 Evaluation Board Top Side Layout.

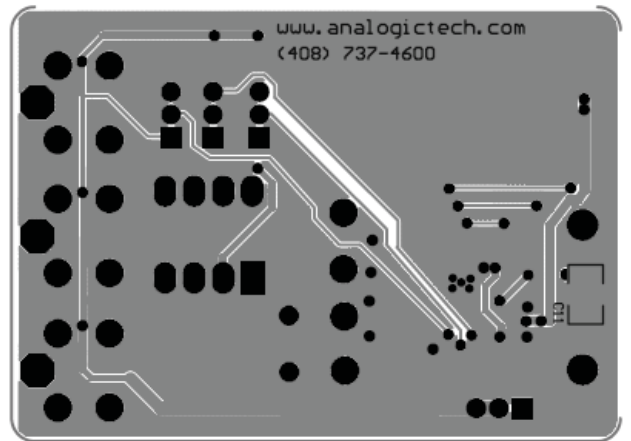

Figure 10: AAT2862 Evaluation Board Bottom Side Layout.

Component	Part Number	Description	Manufacturer
U1	AAT2862IMK	Backlight LED driver with 4 LDOs	AnalogicTech
U2	PIC12F675	8-bit CMOS, FLASH-based μ C; 8-pin PDIP package	Microchip
SW1 – SW3	PTS645TL50	Switch Tact, SPST, 5mm	ITT Industries
R1, R2, R3	Chip Resistor	1k Ω , 5%, 1/4W; 0603	Vishay
R4, R5	Chip Resistor	10k Ω , 5%, 1/4W; 0603	Vishay
R6	Chip Resistor	100k Ω , 5%, 1/4W; 0603	Vishay
R7	Chip Resistor	300 Ω , 5%, 1/4W; 0603	Vishay
C3, C6, C7, C8, C9	GRM188R71A225KE15	2.2 μ F, 10V, X7R, 0603	Murata
C1, C2	GRM216R61A105KA01	1 μ F, 10V, X5R, 0603	Murata
C4, C5	GRM18x	4.7 μ F, 10V, X5R, 0603	Murata
D1-D8	LW M673	Mini TOPLED White LED; SMT	Osram
LED9	CMD15-21SRC/TR8	Red LED; 1206	Chicago Miniature Lamp
J1, J2, J3, J4	PRPN401PAEN	Conn. Header, 2mm zip	Sullins Electronics

Table 15: AAT2862 Evaluation Board Component Listing.

Ordering Information

Package	Part Marking ¹	Part Number (Tape and Reel) ²
TQFN34-24	6RXY	AAT2862IMK-T1



All AnalogicTech products are offered in Pb-free packaging. The term “Pb-free” means semiconductor products that are in compliance with current RoHS standards, including the requirement that lead not exceed 0.1% by weight in homogeneous materials. For more information, please visit our website at <http://www.analogictech.com/about/quality.aspx>.

Package Information

TQFN34-24³

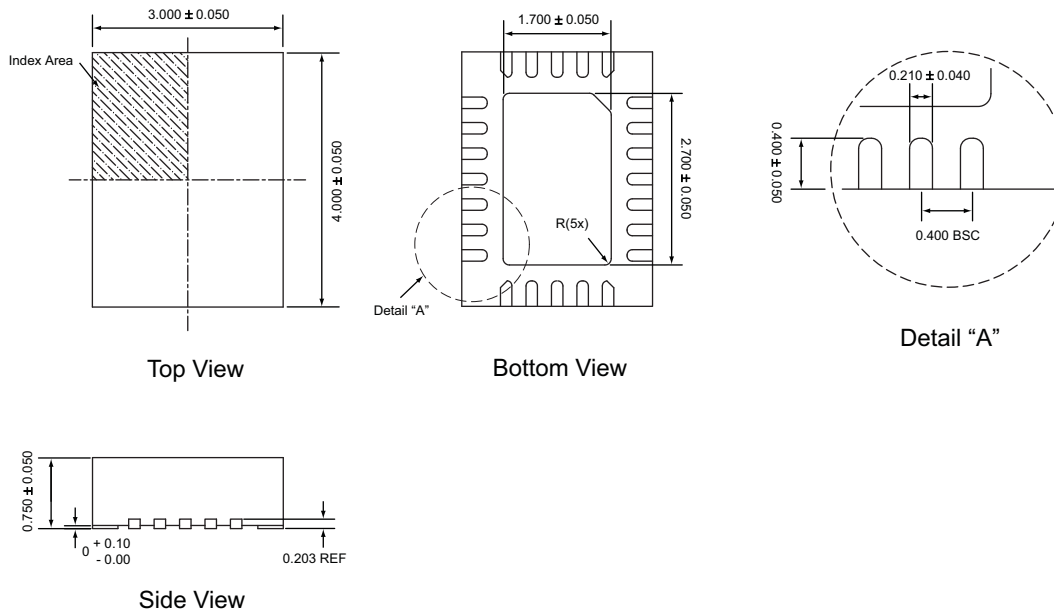

All dimensions in millimeters.

1. XYY = assembly and date code.
2. Sample stock is generally held on part numbers listed in **BOLD**.
3. The leadless package family, which includes QFN, TQFN, DFN, TDFN, and STDFN, has exposed copper (unplated) at the end of the lead terminals due to the manufacturing process. A solder fillet at the exposed copper edge cannot be guaranteed and is not required to ensure a proper bottom solder connection.

Advanced Analogic Technologies, Inc.
3230 Scott Boulevard, Santa Clara, CA 95054
Phone (408) 737-4600
Fax (408) 737-4611



© Advanced Analogic Technologies, Inc. AnalogicTech cannot assume responsibility for use of any circuitry other than circuitry entirely embodied in an AnalogicTech product. No circuit patent licenses, copyrights, mask work rights, or other intellectual property rights are implied. AnalogicTech reserves the right to make changes to their products or specifications or to discontinue any product or service without notice. Except as provided in AnalogicTech's terms and conditions of sale, AnalogicTech assumes no liability whatsoever, and AnalogicTech disclaims any express or implied warranty relating to the sale and/or use of AnalogicTech products including liability or warranties relating to fitness for a particular purpose, merchantability, or infringement of any patent, copyright or other intellectual property right. In order to minimize risks associated with the customer's applications, adequate design and operating safeguards must be provided by the customer to minimize inherent or procedural hazards. Testing and other quality control techniques are utilized to the extent AnalogicTech deems necessary to support this warranty. Specific testing of all parameters of each device is not necessarily performed. AnalogicTech and the AnalogicTech logo are trademarks of Advanced Analogic Technologies Incorporated. All other brand and product names appearing in this document are registered trademarks or trademarks of their respective holders.