

BIPOLAR ANALOG INTEGRATED CIRCUIT

μ PC1031H2

VERTICAL DEFLECTION DEVICE FOR MONOCHROME TV AND SMALL-SIZED COLOR TV

DESCRIPTION

The μ PC1031H2 is a semiconductor integrated circuit for use in vertical-deflection circuit of monochrome TV and small sized color TV.

It oscillates Vertical signal synchronizing with Vertical synchronization signal, and puts out the Vertical Deflection current with the single chip.

And as it has some compensating circuits against the effect of temperature in it, it shows excellent characteristics.

It uses a Single In-line Package easily mountable on heatsink.

FEATURES

- Less number of required, external components.
- Wide range of operational voltage (9 to 18 volts).
- Freely adjustable pull-in range (by the resistor be put between terminal 5 and the ground, and presenting time constant of integrating circuit).
- Adjustable blanking pulse-width.
- Large output current-capacity ($2 A_{p-p}$).
- Built-in adjusting circuit for flyback time.
- Easy mounting on printed circuit board.

PACKAGE DIMENSIONS in millimeters (inches)

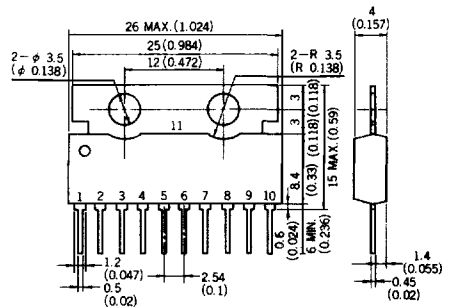

BLOCK DIAGRAM

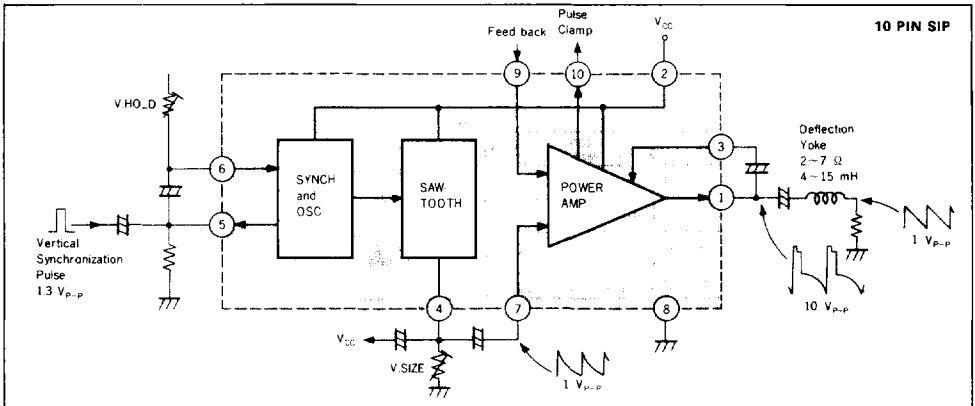

ABSOLUTE MAXIMUM RATINGS (T_a = 25 °C)

Power Supply Voltage	V _{CC}	20	V
Output Current	I _{p-p}	2	A _{p-p}
Power Dissipation	P _{d1}	1.5 (T _a = +75 °C) Without heatsink	W
Power Dissipation	P _{d2}	2.15 (T _a = +75 °C) With aluminum heatsink (31.6 x 31.6 x 1mm t)	W
Operating Temperature Range	T _{opt}	- 20 to +75	°C
Storage Temperature Range	T _{stg}	- 40 to +150	°C

ELECTRICAL CHARACTERISTICS (V_{CC} = 12 V, T_a = 25 ±3 °C)

CHARACTERISTIC	SYMBOL	MIN.	TYP.	MAX.	UNIT	TEST CKT.	TEST CONDITIONS
Circuit Current	I _{CC}	15	30	46	mA	1	No input signal and no load condition
Output Terminal Voltage	V _N	5.6	6.0	6.4	V	1	No input signal and no load condition
Vertical Oscillation Frequency	f _V		50/60		Hz	1	Synchronization signal voltage applied at terminal 5 is 1.3 V _{p-p}
Free-running Frequency	f _{VO}	53	60	67	Hz	1	Oscillation capacitor; 1 μF (Tantalum) resistor; 38.1 k ohms
Pull-in Range	f _p	-10	-12		Hz	1	With specified integration circuit, applied voltage of synchronization signal is 1.3 V _{p-p} at terminal 5
Drift of Free-running Frequency vs. Power Supply Voltage	Δf _{VO}			±1.0	Hz	1	Frequency drift from standard frequency (f _{VO} 60 Hz at V _{CC} = 12 V) vs. power supply voltage (V _{CC} = 12 ±2 V)
Deviation of Pull-in Range vs. Power Supply Voltage	Δf _p			±3.0	Hz	1	Deviation from the frequency range for pull in (at V _{CC} = 12 V) vs. power supply voltage (V _{CC} = 12 ±2 V)
Output Saturation Voltage	V _{sat}		1.3	1.6	V	1	Output current : 0.7 A
Output pulse width of terminal 4	t _c	300	420	600	μs	1	Oscillation capacitor; 1 μF (Tantalum) resistor; 38.1 k ohms

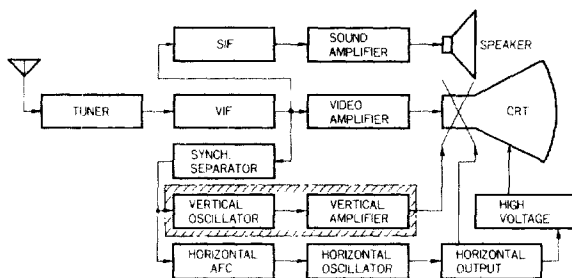

FUNCTION

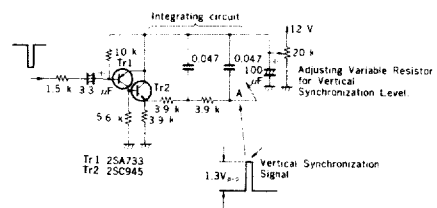
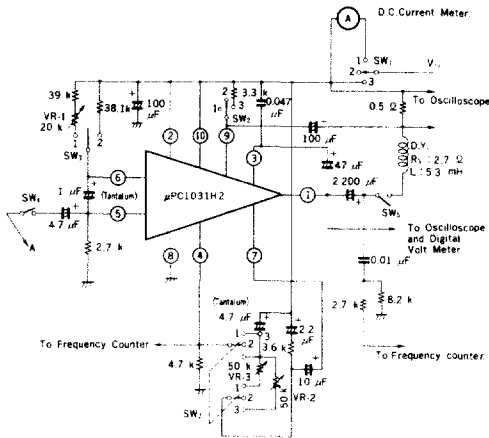

TEST CIRCUIT

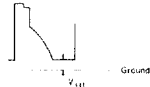

SWITCH POSITION

CHARACTERISTIC	SYMBOL	SWITCH POSITION					MEASUREMENT METHOD
		SW1	SW2	SW3	SW4	SW5	
Circuit current	I_{CC}	1	2	2	OFF	OFF	—
Output terminal voltage	V_N	1	2	2	OFF	OFF	Measure the voltage at terminal 1, by using a digital voltmeter.
Vertical oscillation frequency	f_V	3	1	1	ON	ON	Apply the synchronization signal of 1.3 V _{p-p} to terminal 5.
Free-running oscillation frequency	f_{VO}	3	1	2	OFF	ON	—
Pull-in range	f_P	3	1	1	OFF ON	ON	Adjust the pull in frequency, by using VR-1, after SW4 has been turned to the OFF position, and then confirm that the perfect synchronization is obtained when SW4 has been turned to the ON position.
Drift of free-running frequency vs. power supply voltage	Δf_{VO}	3	1	2	OFF	ON	Vary the power supply voltage in the range of $V_{CC} = 12 \pm 2$ V.
Deviation of frequency range for pull in vs. power supply voltage	Δf_P	3	1	1	OFF ON	ON	Vary the power supply voltage in the range of $V_{CC} = 12 \pm 2$ V.
Output saturation voltage	V_{sat}	3	3	1	ON	ON	Adjust VR-2 so that the terminal voltage across the resistor of 0.5 ohms may be 0.7 V _{p-p} , and then measure the waveform at the output terminal. 
Output pulse width of terminal 4	t_o	3	2	2	OFF	ON	Measure the output pulse width at terminal 4, by using an oscilloscope. 

TYPICAL CHARACTERISTICS (T_a = 25 °C)

POWER DISSIPATION vs. AMBIENT TEMPERATURE

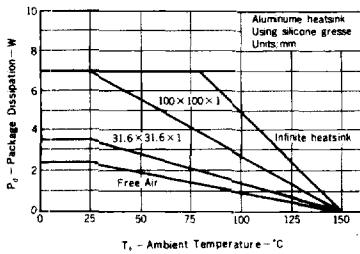

FREE-RUNNING OSCILLATION FREQUENCY vs. AMBIENT TEMPERATURE

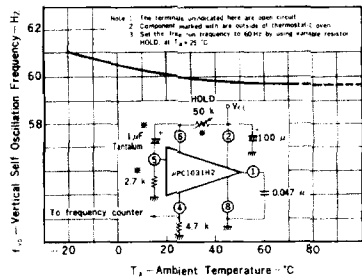

OUTPUT TERMINAL VOLTAGE vs. AMBIENT TEMPERATURE

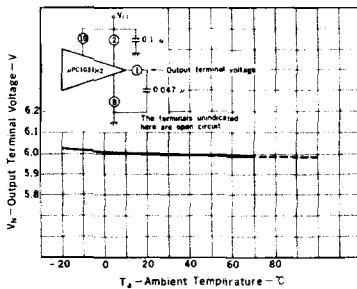

FREE-RUNNING OSCILLATION FREQUENCY vs. POWER SUPPLY VOLTAGE

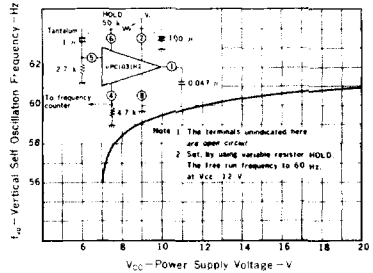

VERTICAL PULL IN FREQUENCY vs. POWER SUPPLY VOLTAGE

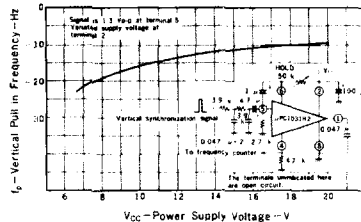

OUTPUT TERMINAL VOLTAGE vs. POWER SUPPLY VOLTAGE

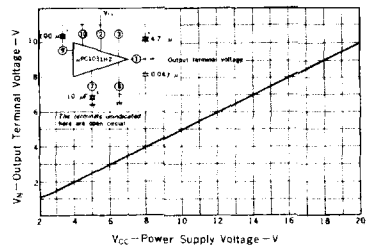

ADJUSTMENT METHODS OF FLYBACK TIME FOR THE μPC1031H2

Since the flyback time of the vertical output voltage is sometimes elongated excessively by the constant of the deflection yoke, a part of the flyback time appears in the television picture. For the prevention of this elongation, the following methods are available.

The confirmation experiment is requested beforehand, since the adjustment of the flyback time is depend on the constant of the deflection yoke used in the TV set.

Method 1. Adjustment of the clamping level of the flyback pulse at terminal 10.

The blanking pulse level is normally clamped by the power supply voltage connected to terminal 10.

The flyback time, however, can be adjusted by the change of the voltage at terminal 10. Adjust the clamping voltage at terminal 10 between the power supply voltage and 18 volts.

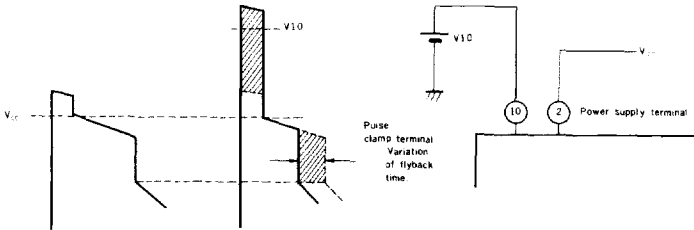

Method 2. Adjustment through decreasing of middle potential of the output by a resistor connected between terminal 2 and 9.

The voltage at terminal 9 is a half of the power supply voltage. The middle potential of the output, however, can be decreased by the voltage drop across resistor R₂₅, when the current is supplied to R₂₅ through a resistor be put between terminals 2 and 9.

The potential variation, due to R_A, for the middle potential of the output is given by the following equation that has a temperature coefficient.

$$-\Delta V_N = \frac{V_{CC} R_{25}}{2 R_A} [1 + 0.002 (T_{opt} - 25)]$$

The adjustment should be made so that the waveform amplitude of the output may not be clipped by the saturation voltage level of the output in the operating temperature range.

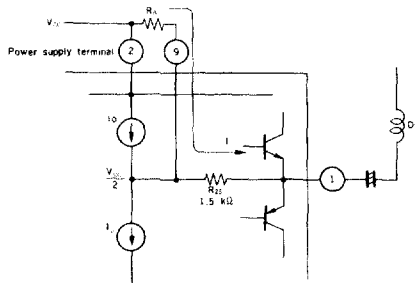

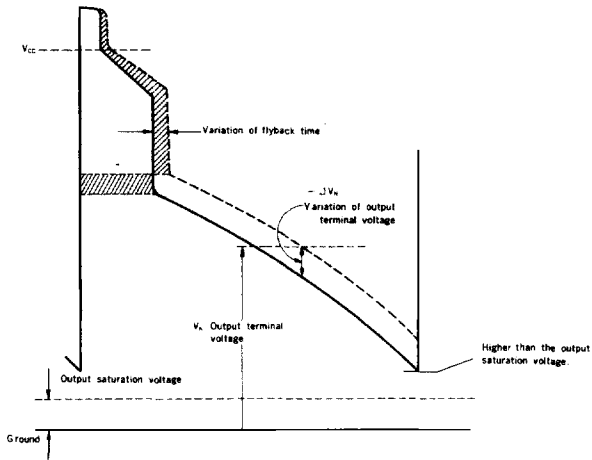

Typical Variation Characteristic of Flyback Time vs. Resistance Value between Terminal 2 and 9.

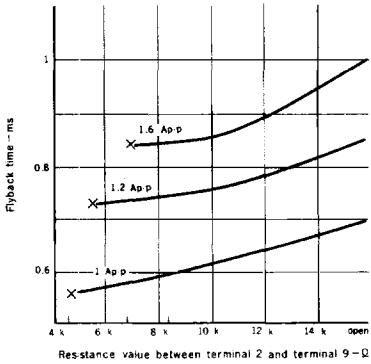

Typical Variation Characteristic of Flyback Time vs. Clamping Voltage at Terminal 10.

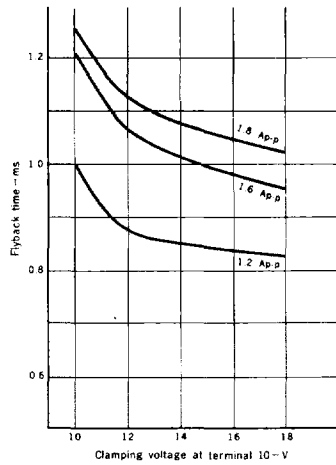

EXAMPLE OF PERIPHERAL CIRCUIT FOR THE μPC1031H2

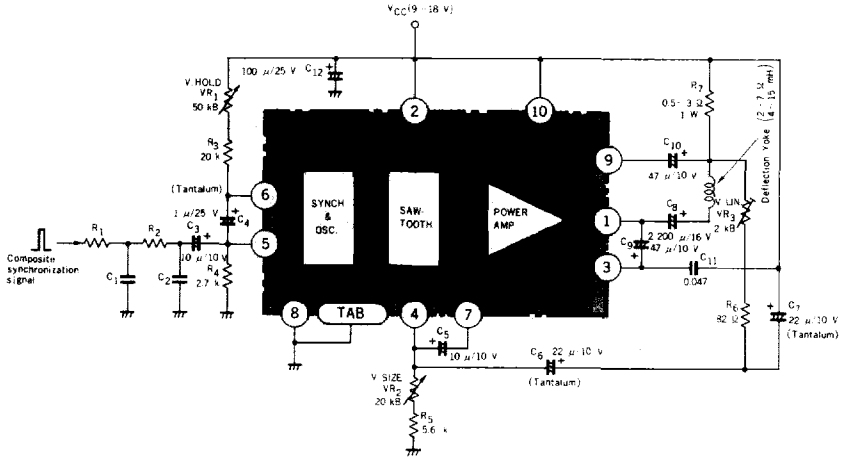

Typical Example of Components Layout with the μPC1031H2 on P.C. Board

P.C. Board Pattern and Components Layout.

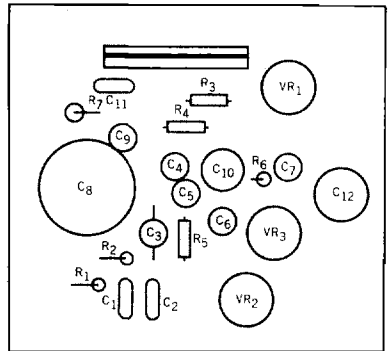
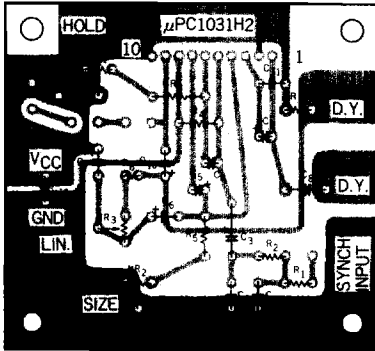

COMPONENTS

SYMBOL SPECIFICATION

R ₁	—	
R ₂	—	
R ₃	20 kΩ	1/4 W
R ₄	2.7 kΩ	1/4 W
R ₅	5.6 kΩ	1/4 W
R ₆	82 Ω	1/4 W
R ₇	0.5 to 3 Ω, 1 to 2 W	
C ₁	—	
C ₂	—	
C ₃	10 μF	10 V
C ₄	1 μF	25 V (Tantalum)

SYMBOL SPECIFICATION

C ₅	10 μF	10 V
C ₆	22 μF	10 V (Tantalum)
C ₇	22 μF	10 V (Tantalum)
C ₈	2 200 μF	16 V
C ₉	47 μF	10 V
C ₁₀	47 μF	10 V
C ₁₁	0.047 μF	
C ₁₂	100 μF	25 V
VR ₁	50 kΩ-B	
VR ₂	20 kΩ-B	
VR ₃	2 kΩ-B	

EXAMPLE OF PERIPHERAL CIRCUIT FOR THE μPC1031H2

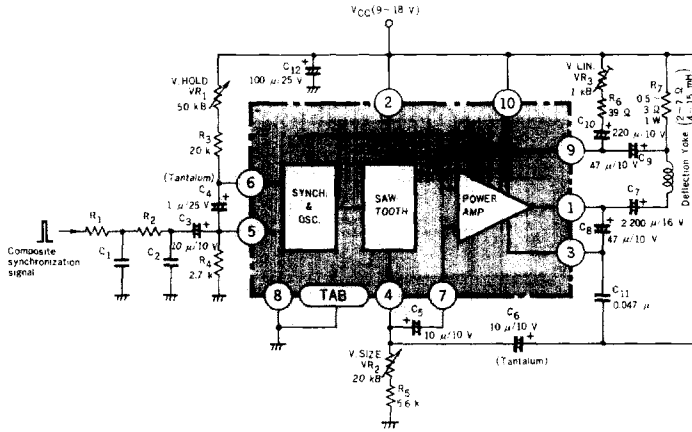

Typical Example of Components Layout with the μPC1031H2 on P.C. Board
P.C. Board Pattern and Components Layout

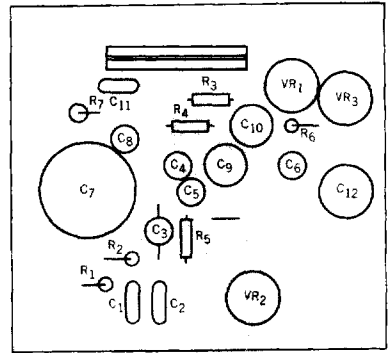
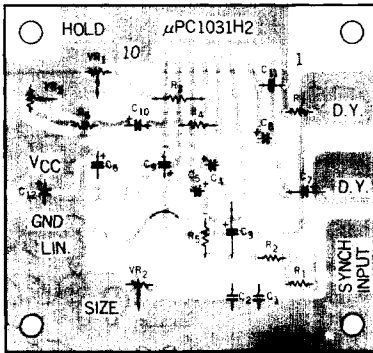

COMPONENTS

SYMBOL	SPECIFICATION
R ₁	—
R ₂	—
R ₃	20 kΩ 1/4 W
R ₄	2.7 kΩ 1/4 W
R ₅	5.6 kΩ 1/4 W
R ₆	39 Ω 1/4 W
R ₇	0.5 to 3 Ω, 1 to 2 W
C ₁	—
C ₂	—
C ₃	10 μF 10 V
C ₄	1 μF 25 V (Tantalum)

SYMBOL	SPECIFICATION
C ₅	10 μF 10 V
C ₆	10 μF 10 V (Tantalum)
C ₇	2 200 μF 16 V
C ₈	47 μF 10 V
C ₉	47 μF 10 V
C ₁₀	220 μF 10 V
C ₁₁	0.047 μF
C ₁₂	100 μF 25 V
VR ₁	50 kΩ-B
VR ₂	20 kΩ-B
VR ₃	1 kΩ-B