

MHCC、MHCI Series



MHCC series is designed for low profile type with low RDC and ultra large current. Its molded magnetic shielded type is suitable for high-density mounting and ultra low buzz noise. Soldering conditions can be easily confirmed when mounting onto the board. This series also provides customers with embossed carrier type packaging for automatic mounting machine.

Features

- RoHS compliant
- Low profile type
- Shielded construction
- Ultra low buzz noise due to molding construction

Applications

- High density DC/DC converters
- POL converters
- High current VRM/VRD for notebook / Server / desktop CPUs
- High speed charger
- For thickness less than 1.2mm, suitable for low profile applications e.g., Ultra thin NB/Monitor/TV/Tablet

Product Identification

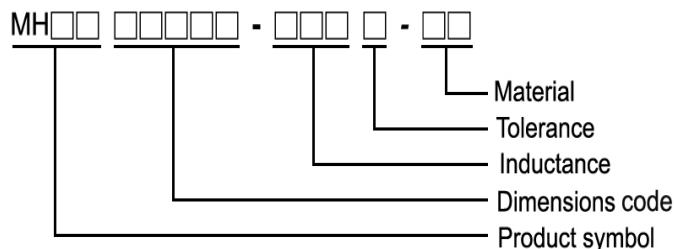

Shape and Dimensions

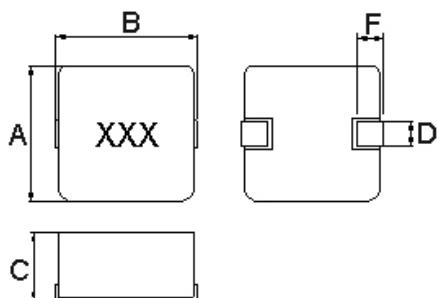

Dimensions in mm

TYPE	A	B Max	C Max	D	F
04012	4.1±0.2	4.6±0.2	1.2	1.5±0.3	1.0±0.5
04015	4.1±0.2	4.6±0.2	1.5	1.5±0.3	1.0±0.5
04020	4.1±0.2	4.6±0.2	2.0	1.5±0.3	1.0±0.5
05012	5.4±0.35	5.7±0.2	1.2	2.0±0.3	1.5±0.3
05015	5.4±0.35	5.7±0.2	1.5	2.0±0.3	1.5±0.3
05018	5.4±0.35	5.7±0.2	1.8	2.0±0.3	1.5±0.3
05020	5.4±0.35	5.7±0.2	1.8±0.2	2.0±0.3	1.5±0.3
05030	5.4±0.35	5.7±0.2	3.0	2.0±0.3	1.5±0.3
06012	6.6±0.2	7.3	1.2	2.9	1.6±0.5
06015	6.6±0.2	7.3	1.3±0.2	2.9	1.6±0.5
06018	6.6±0.2	7.3	1.6±0.2	2.9	1.6±0.5
06024	6.6±0.2	7.3	2.4	2.9	1.6±0.5
06030	6.6±0.2	7.3	3.0	2.9	1.6±0.5
10030	10.1±0.3	11.6	3.0	3.0	2.5±0.5
10040	10.1±0.3	11.6	4.0	3.0	2.5±0.5
12035	12.6±0.2	13.8	3.5	3.7	2.7±0.7
12050	12.6±0.2	13.8	5.0	3.7	2.7±0.7
12060	12.6±0.2	13.8	6.0	3.7	2.7±0.7

Recommended Pattern

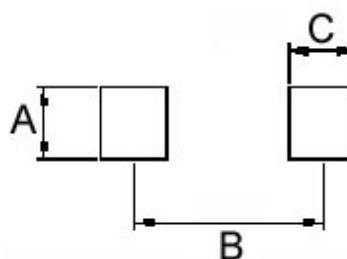

Dimensions in mm

TYPE	A	B	C
04012	2.5	3.7	1.5
04015	2.5	3.7	1.5
04020	2.5	3.7	1.5
05012	2.5	4.1	1.9
05015	2.5	4.1	1.9
05018	2.5	4.1	1.9
05020	2.5	4.1	1.9
05030	2.5	4.1	1.9
06012	3.5	6.05	2.35
06015	3.5	6.05	2.35
06018	3.5	6.05	2.35
06024	3.5	6.05	2.35
06030	3.5	6.05	2.35
10030	4.0	9.5	3.5
10040	4.0	9.5	3.5
12035	5.0	10.5	4.0
12050	5.0	10.5	4.0
12060	5.0	10.5	4.0

Electrical Characteristics

Part Number	Inductance (μH)	Tolerance ($\pm\%$)	Test Frequency (KHz)	I _{rms} (A)Typ.	I _{sat} (A)Typ.	RDC ($\text{m}\Omega$)Max
MHCI04012-R22M-R8	0.22	20	100	8.5	11.5	12
MHCI04012-R47M-R8	0.47	20	100	5.0	7.0	25
MHCI04012-R68M-R8	0.68	20	100	4.5	6.0	36
MHCI04012-1R0M-R8	1.0	20	100	4.2	5.2	47
MHCI04012-2R2M-R8	2.2	20	100	2.75	3.5	83.5
MHCI04012-4R7M-R8	4.7	20	100	1.8	2.8	195

- I_{rms} DC current (A) that will cause an approximate ΔT of 40°C
- I_{sat} DC current (A) that will cause L to drop approximately 30%
- Tolerance : M= $\pm 20\%$
- L : WK 3260B, 100KHz 0.5V
- R_{dc} : CHEN HWA 502
- Operating temperature range from -55°C to 125°C. (Including self - temperature rise)

Test Instruments : WK3260B Impedance / Material Analyzer

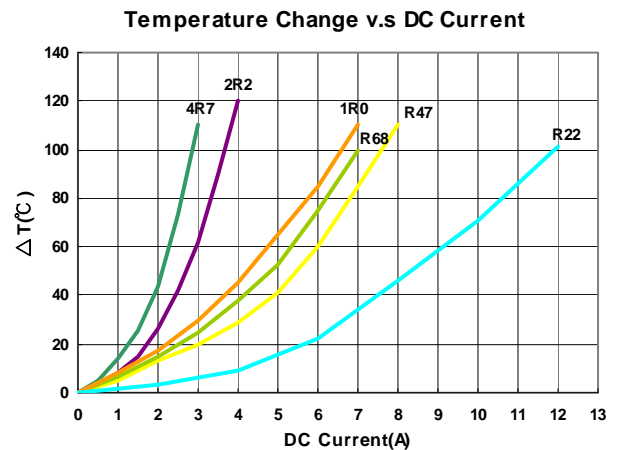
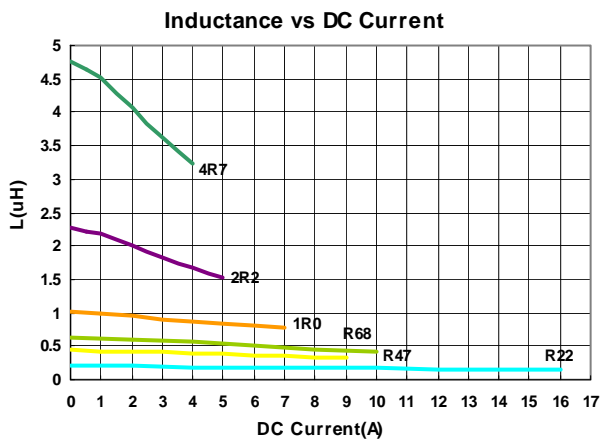

Electrical Characteristics

Part Number	Inductance (μH)	Tolerance ($\pm\%$)	Test Frequency (KHz)	I _{rms} (A)Typ.	I _{sat} (A)Typ.	RDC ($\text{m}\Omega$)Max
MHCI04015-1R0M-R8	1.0	20	100	4	7	42
MHCI04015-1R5M-R8	1.5	20	100	3.5	6	50
MHCI04015-2R2M-R8	2.2	20	100	3	5	79
MHCI04015-3R3M-R8	3.3	20	100	2.3	4.5	132
MHCI04015-4R7M-R8	4.7	20	100	2	4	146

- I_{rms} DC current (A) that will cause an approximate ΔT of 40°C
- I_{sat} DC current (A) that will cause L to drop approximately 30%
- Tolerance : M= $\pm 20\%$
- L : WK 3260B, 100KHz 0.5V
- R_{dc} : CHEN HWA 502
- Operating temperature range from -55°C to 125°C. (Including self - temperature rise)

Test Instruments : WK3260B Impedance / Material Analyzer

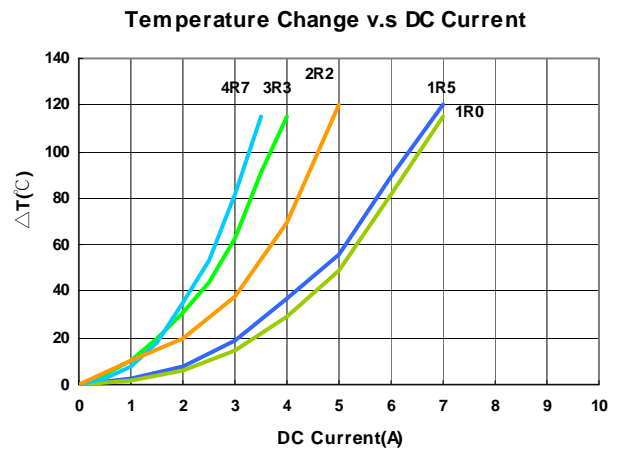
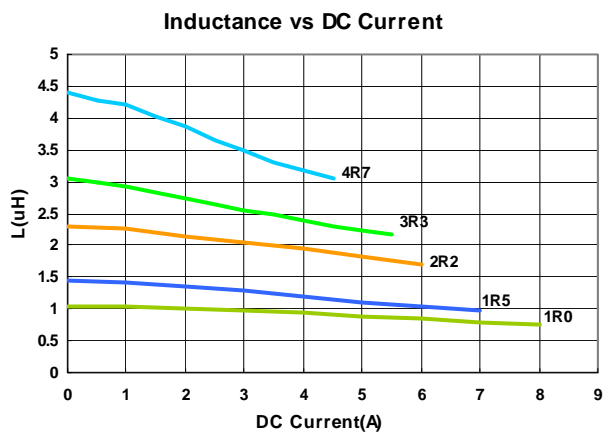

Electrical Characteristics

Part Number	Inductance (μH)	Tolerance ($\pm\%$)	Test Frequency (KHz)	I _{rms} (A)Typ.	I _{sat} (A)Typ.	RDC ($\text{m}\Omega$)Max
MHCI04020-R10M-R8	0.10	20	100	12.0	25	4
MHCI04020-R22M-R8	0.22	20	100	9.0	12.5	6.6
MHCI04020-R47M-R8	0.47	20	100	7.0	9.5	14
MHCI04020-1R0M-R8	1.0	20	100	4.5	7.0	27
MHCI04020-1R5M-R8	1.5	20	100	4.0	6.0	46
MHCI04020-2R2M-R8	2.2	20	100	3.0	5.0	58
MHCI04020-3R3M-R8	3.3	20	100	2.5	4.0	87
MHCI04020-4R7M-R8	4.7	20	100	2.2	3.0	105
MHCI04020-6R8M-R8	6.8	20	100	2.0	2.5	135
MHCI04020-8R2M-R8	8.2	20	100	2.0	2.5	216
MHCI04020-100M-R8	10	20	100	1.6	2.0	258

- I_{rms} DC current (A) that will cause an approximate ΔT of 40°C
- I_{sat} DC current (A) that will cause L to drop approximately 30%
- Tolerance : M= $\pm 20\%$
- L : WK 3260B, 100KHz 0.5V
- R_{dc} : CHEN HWA 502
- Operating temperature range from -55°C to 125°C. (Including self - temperature rise)

Test Instruments : WK3260B Impedance / Material Analyzer

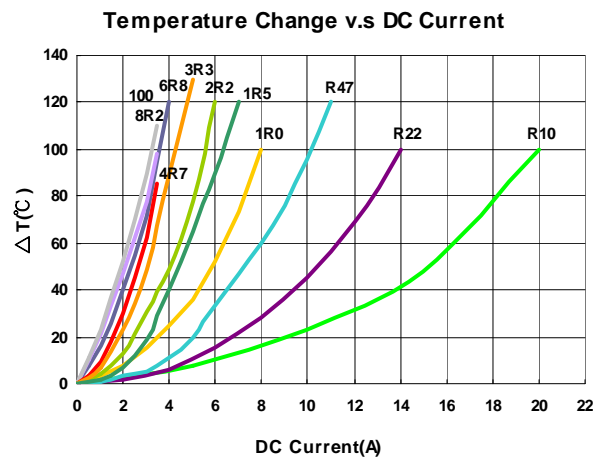
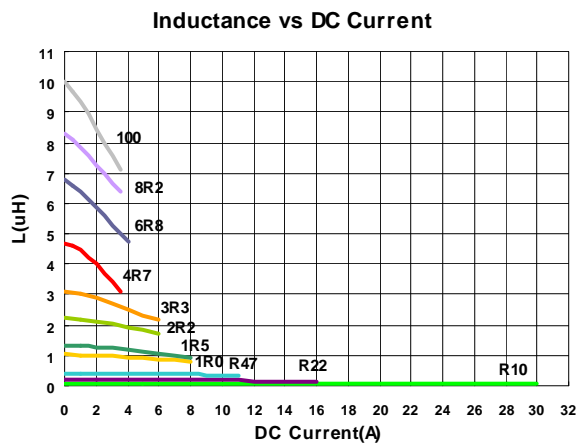

Electrical Characteristics

Part Number	Inductance (μH)	Tolerance ($\pm\%$)	Test Frequency (KHz)	I _{rms} (A)Typ.	I _{sat} (A)Typ.	RDC ($\text{m}\Omega$)Max
MHCI05012-2R2M-R8A	2.2	20	100	3.5	4	76
MHCI05012-6R8M-R8A	6.8	20	100	2.0	2.3	250

- I_{rms} current (A) that will cause an approximate ΔT of 40°C
- I_{sat} current (A) that will cause L to drop approximately 30%
- Tolerance : M= $\pm 20\%$
- L : WK 3260B, 100KHz 0.5V
- R_{dc} : CHEN HWA 502
- Operating temperature range from -55°C to 125°C. (Including self - temperature rise)

Test Instruments : WK3260B Impedance / Material Analyzer

Inductance vs DC Current

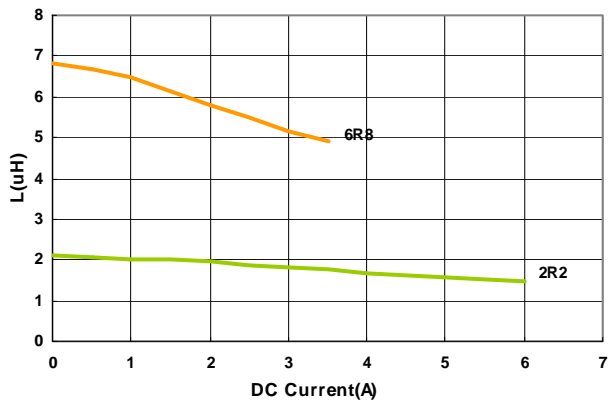

Temperature Change v.s DC Current

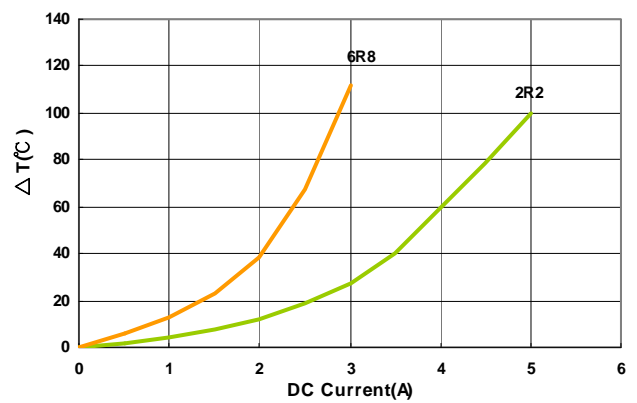

Electrical Characteristics

Part Number	Inductance (μH)	Tolerance ($\pm\%$)	Test Frequency (KHz)	I _{rms} (A)Typ.	I _{sat} (A)Typ.	RDC ($\text{m}\Omega$)Max
MHCI05015-R68M-R8	0.68	20	100	6.0	10	23
MHCI05015-1R0M-R8	1.0	20	100	5.0	8.0	33
MHCI05015-1R5M-R8	1.5	20	100	4.0	6.0	50
MHCI05015-2R2M-R8	2.2	20	100	3.3	6.0	68
MHCI05015-3R3M-R8	3.3	20	100	3.0	5.0	84
MHCI05015-4R7M-R8	4.7	20	100	2.5	4.0	135
MHCI05015-5R6M-R8	5.6	20	100	2.2	3.5	175
MHCI05015-6R8M-R8	6.8	20	100	2.0	3.0	192
MHCI05015-100M-R8	10	20	100	1.5	2.0	195

- I_{rms} DC current (A) that will cause an approximate ΔT of 40°C
- I_{sat} DC current (A) that will cause L to drop approximately 30%
- Tolerance : M= $\pm 20\%$
- L : WK 3260B, 100KHz 0.5V
- R_{dc} : CHEN HWA 502
- Operating temperature range from -55°C to 125°C. (Including self - temperature rise)

Test Instruments : WK3260B Impedance / Material Analyzer

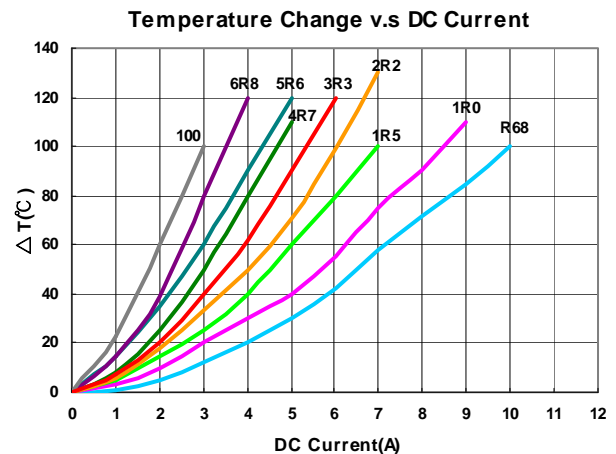
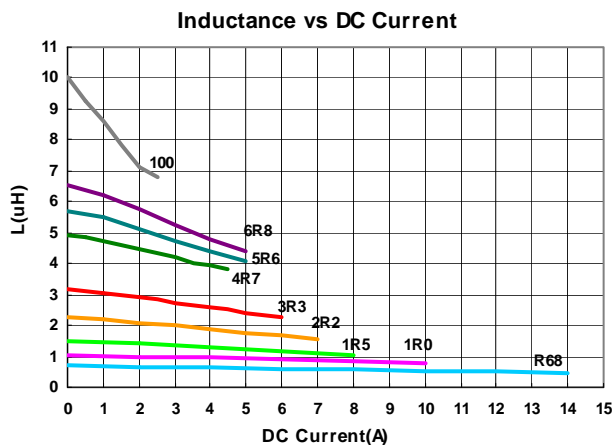

Electrical Characteristics

Part Number	Inductance (μH)	Tolerance ($\pm\%$)	Test Frequency (KHz)	I _{rms} (A)Typ.	I _{sat} (A)Typ.	RDC ($\text{m}\Omega$)Max
MHCI05018-R47M-R8A	0.47	20	100	10.5	15.5	9.0
MHCI05018-1R0M-R8A	1.0	20	100	8.0	9.0	17
MHCI05018-2R2M-R8A	2.2	20	100	5.0	6.5	35
MHCI05018-6R8M-R8A	6.8	20	100	2.8	3.4	120

- I_{rms} DC current (A) that will cause an approximate ΔT of 40°C
- I_{sat} DC current (A) that will cause L to drop approximately 30%
- Tolerance : M= $\pm 20\%$
- L : WK 3260B, 100KHz 0.5V
- R_{dc} : CHEN HWA 502
- Operating temperature range from -55°C to 125°C. (Including self - temperature rise)

Test Instruments : WK3260B Impedance / Material Analyzer

Inductance vs DC Current

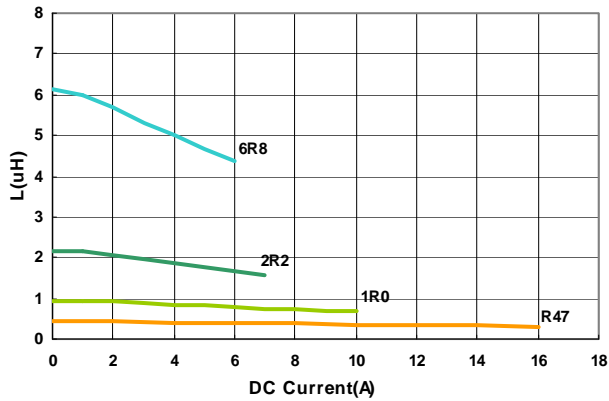

Temperature Change v.s DC Current

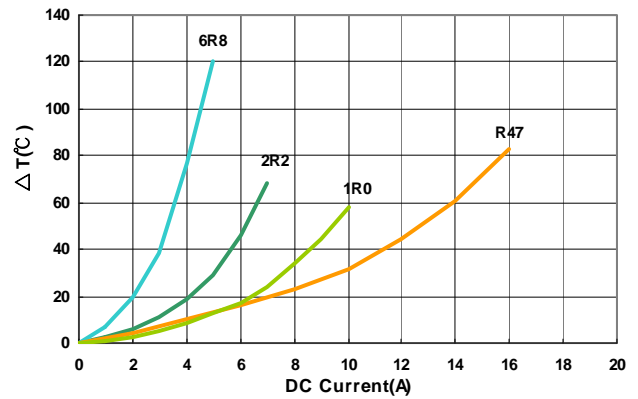

Electrical Characteristics

Part Number	Inductance (uH)	Tolerance (±%)	Test Frequency (KHz)	I _{rms} (A)Typ.	I _{sat} (A)Typ.	RDC (mΩ)Max
MHCI05020-1R0M-R8	1.0	20	100	6.0	7.0	30
MHCI05020-1R5M-R8	1.5	20	100	5.5	6.5	35
MHCI05020-2R2M-R8	2.2	20	100	4.0	6.0	45
MHCI05020-3R3M-R8	3.3	20	100	3.5	5.5	60
MHCI05020-4R7M-R8	4.7	20	100	3.0	5.0	90
MHCI05020-5R6M-R8	5.6	20	100	2.8	4.5	120
MHCI05020-6R8M-R8	6.8	20	100	2.8	4.5	125
MHCI05020-100M-R8	10	20	100	2.3	4.0	180

- I_{rms} DC current (A) that will cause an approximate ΔT of 40°C
- I_{sat} DC current (A) that will cause L to drop approximately 30%
- Tolerance : M= ±20%
- L : WK 3260B, 100KHz 0.5V
- Rdc : CHEN HWA 502
- Operating temperature range from -55°C to 125°C . (Including self - temperature rise)

Test Instruments : WK3260B Impedance / Material Analyzer

Inductance v.s DC Current

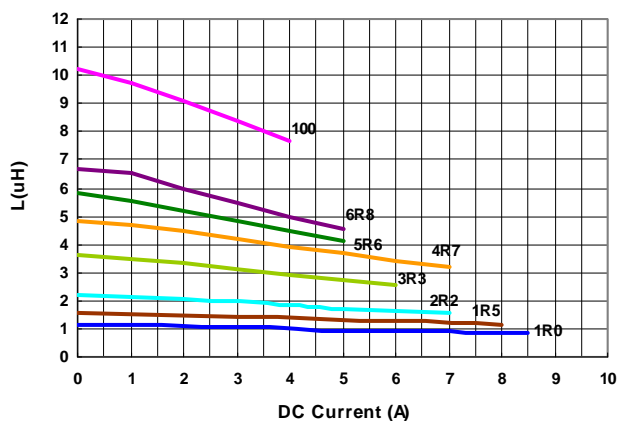

Temperature Change v.s DC Current

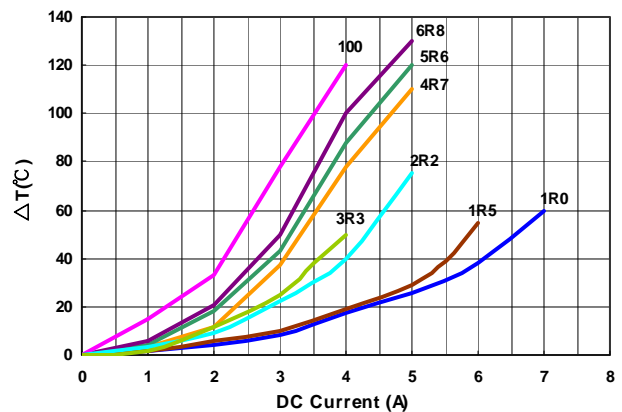

Electrical Characteristics

Part Number	Inductance (uH)	Tolerance (±%)	Test Frequency (KHz)	I _{rms} (A)Typ.	I _{sat} (A)Typ.	RDC (mΩ)Max
MHCI05030-R68M-R8	0.68	20	100	8.0	14	12
MHCI05030-1R0M-R8	1.0	20	100	7.0	11	15
MHCI05030-1R2M-R8	1.2	20	100	6.5	11	15
MHCI05030-1R5M-R8	1.5	20	100	6.0	10	25
MHCI05030-2R2M-R8	2.2	20	100	5.0	8	35
MHCI05030-3R3M-R8	3.3	20	100	4.5	7	46
MHCI05030-4R7M-R8	4.7	20	100	4.0	6	60

- I_{rms} DC current (A) that will cause an approximate ΔT of 40°C
- I_{sat} DC current (A) that will cause L to drop approximately 30%
- Tolerance : M= ±20%
- L : WK 3260B, 100KHz 0.5V
- R_{dc} : CHEN HWA 502
- Operating temperature range from -55°C to 125°C. (Including self - temperature rise)

Test Instruments : WK3260B Impedance / Material Analyzer

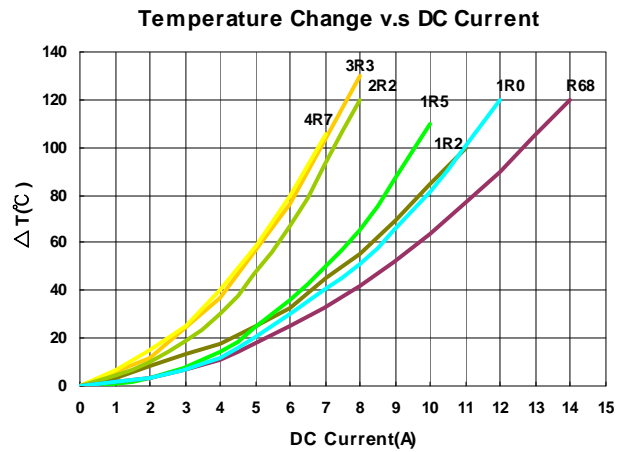
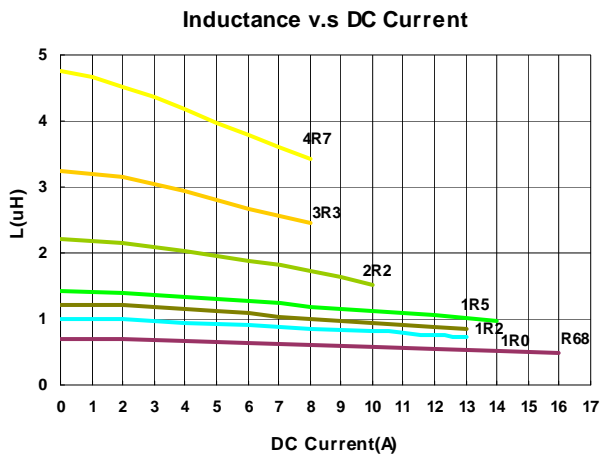

Electrical Characteristics

Part Number	Inductance (μH)	Tolerance ($\pm\%$)	Test Frequency (KHz)	I _{rms} (A)Typ.	I _{sat} (A)Typ.	RDC (m Ω)Max
MHCI06012-6R8M-R8A	6.8	20	100	2.2	2.8	210

- I_{rms} DC current (A) that will cause an approximate ΔT of 40°C
- I_{sat} DC current (A) that will cause L to drop approximately 30%
- Tolerance : M= $\pm 20\%$
- L : WK 3260B, 100KHz 0.5V
- R_{dc} : CHEN HWA 502
- Operating temperature range from -55°C to 125°C. (Including self - temperature rise)

Test Instruments : WK3260B Impedance / Material Analyzer

Inductance vs DC Current

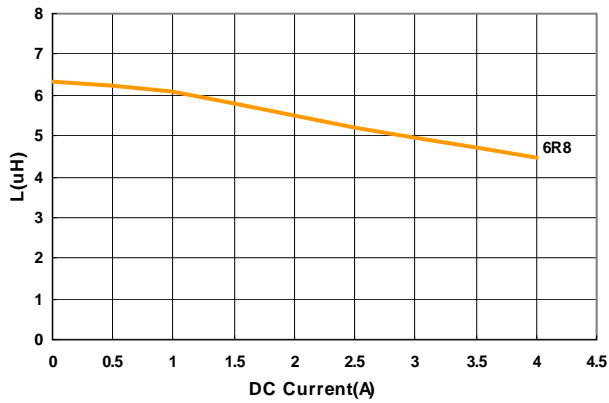

Temperature Change v.s DC Current

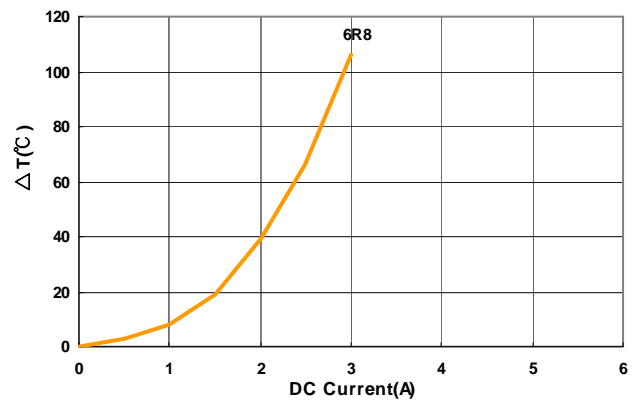

Electrical Characteristics

Part Number	Inductance (μH)	Tolerance ($\pm\%$)	Test Frequency (KHz)	I _{rms} (A)Typ.	I _{sat} (A)Typ.	RDC ($\text{m}\Omega$)Max
MHCI06015-1R0M-R8	1.0	20	100	5.5	9.0	25
MHCI06015-2R2M-R8	2.2	20	100	3.5	6.0	54
MHCI06015-3R3M-R8	3.3	20	100	3.3	5.5	63
MHCI06015-4R7M-R8	4.7	20	100	3.2	4.5	105
MHCI06015-6R8M-R8	6.8	20	100	2.5	4.0	140

- I_{rms} DC current (A) that will cause an approximate ΔT of 40°C
- I_{sat} DC current (A) that will cause L to drop approximately 30%
- Tolerance : M= $\pm 20\%$
- L : WK 3260B, 100KHz 0.5V
- Rdc : CHEN HWA 502
- Operating temperature range from -55°C to 125°C. (Including self - temperature rise)

Test Instruments : WK3260B Impedance / Material Analyzer

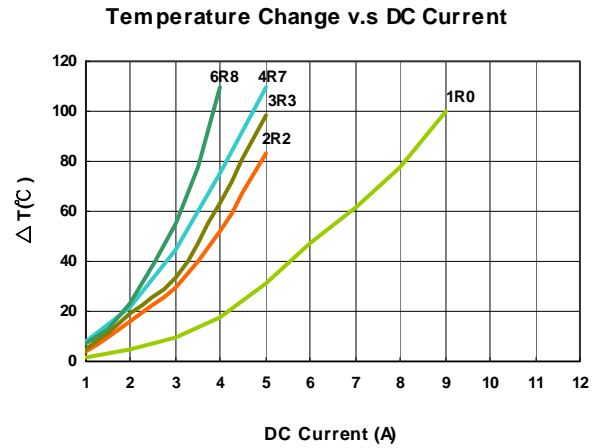
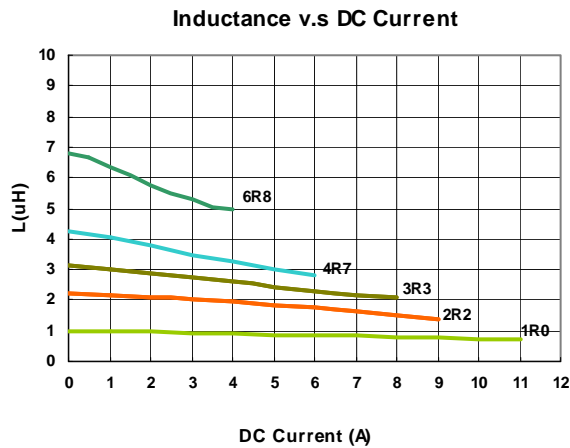

Electrical Characteristics

Part Number	Inductance (μ H)	Tolerance (\pm %)	Test Frequency (KHz)	I _{rms} (A)Typ.	I _{sat} (A)Typ.	RDC (m Ω)Max
MHCI06018-1R0M-R8	1.0	20	100	7.0	10.0	17
MHCI06018-1R5M-R8	1.5	20	100	5.0	10.5	28
MHCI06018-2R2M-R8	2.2	20	100	5.0	8.0	35
MHCI06018-3R3M-R8	3.3	20	100	3.5	8.0	60
MHCI06018-4R7M-R8	4.7	20	100	3.5	5.0	72
MHCI06018-6R8M-R8	6.8	20	100	2.8	3.5	110

- I_{rms} DC current (A) that will cause an approximate ΔT of 40°C
- I_{sat} DC current (A) that will cause L to drop approximately 30%
- Tolerance : M= \pm 20%
- L : WK 3260B, 100KHz 0.5V
- Rdc : CHEN HWA 502
- Operating temperature range from -55°C to 125°C . (Including self - temperature rise)

Test Instruments : WK3260B Impedance / Material Analyzer

Inductance v.s DC Current

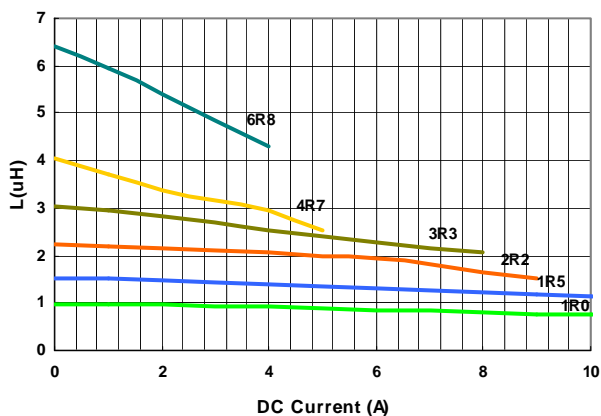

Temperature Change v.s DC Current

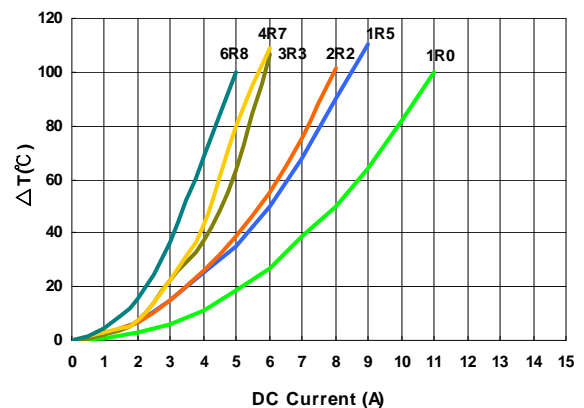

Electrical Characteristics

Part Number	Inductance (μH)	Tolerance ($\pm\%$)	Test Frequency (KHz)	I _{rms} (A)Typ.	I _{sat} (A)Typ.	RDC ($\text{m}\Omega$)Max
MHCI06018-R33M-R8A	0.33	20	100	12	22	6.8
MHCI06018-1R0M-R8A	1.0	20	100	7.0	14	17
MHCI06018-4R7M-R8A	4.7	20	100	3.5	5	70
MHCI06018-100M-R8A	10	20	100	2.3	2.5	155

- I_{rms} DC current (A) that will cause an approximate ΔT of 40°C
- I_{sat} DC current (A) that will cause L to drop approximately 30%
- Tolerance : M= $\pm 20\%$
- L : WK 3260B, 100KHz 0.5V
- R_{dc} : CHEN HWA 502
- Operating temperature range from -55°C to 125°C . (Including self - temperature rise)

Test Instruments : WK3260B Impedance / Material Analyzer

Inductance vs DC Current

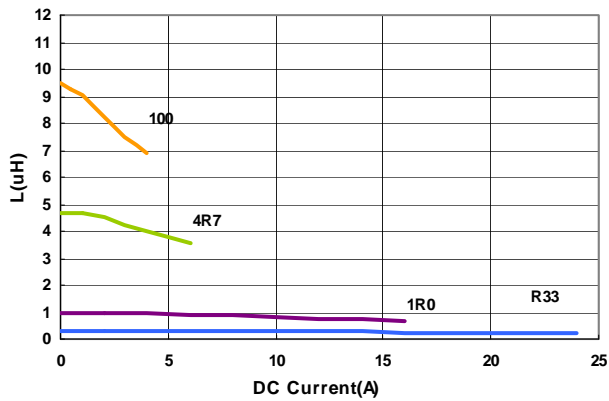

Temperature Change v.s DC Current

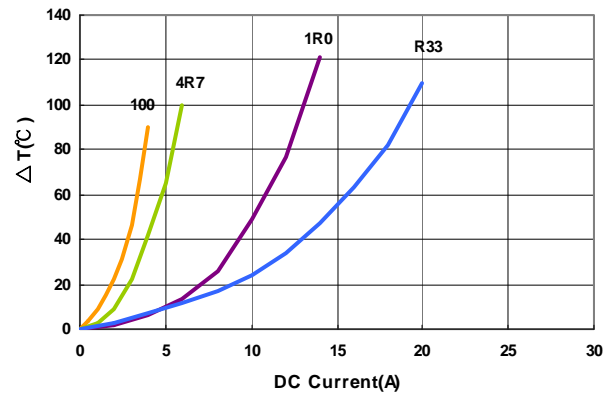

Electrical Characteristics

Part Number	Inductance (μH)	Tolerance ($\pm\%$)	Test Frequency (MHz)	I _{rms} (A)Typ.	I _{sat} (A)Typ.	RDC (m Ω)Max
MHCI06024-R47M-R8	0.47	20	100	13.5	21	6.5
MHCI06024-1R0M-R8	1.0	20	100	9.0	16	13.5
MHCI06024-2R2M-R8	2.2	20	100	6.0	12	28
MHCI06024-4R7M-R8	4.7	20	100	4.5	8	50
MHCI06024-6R8M-R8	6.8	20	100	3.5	4	66
MHCI06024-100M-R8	10	20	100	3.1	4	101

- I_{rms} DC current (A) that will cause an approximate ΔT of 40°C
- I_{sat} DC current (A) that will cause L to drop approximately 30%
- Tolerance : M= $\pm 20\%$
- L : WK 3260B, 100KHz 0.5V
- R_{dc} : CHEN HWA 502
- Operating temperature range from -55°C to 125°C. (Including self - temperature rise)

Test Instruments : WK3260B Impedance / Material Analyzer

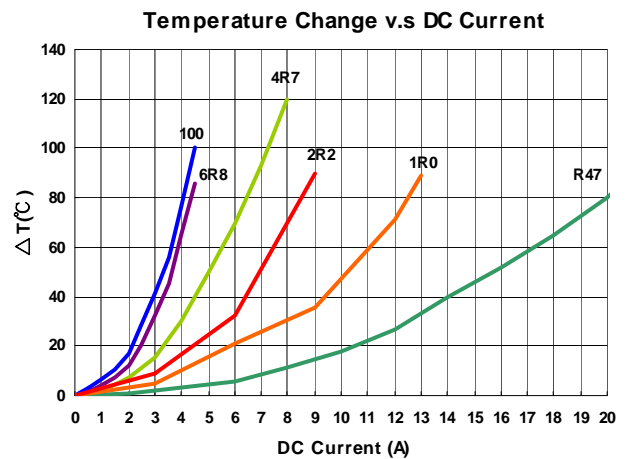
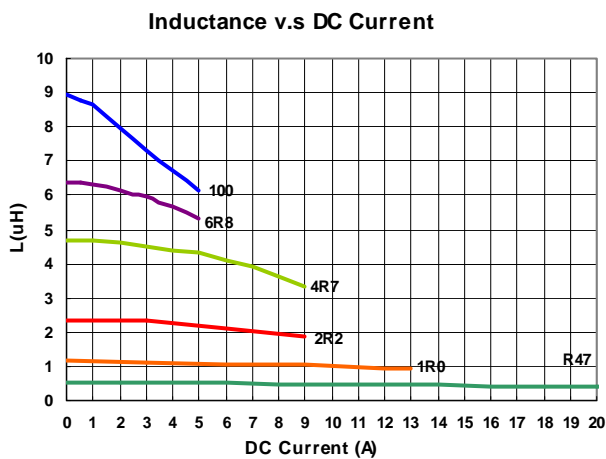

Electrical Characteristics

Part Number	Inductance (μH)	Tolerance ($\pm\%$)	Test Frequency (MHz)	I _{rms} (A)Typ.	I _{sat} (A)Typ.	RDC (m Ω)Max
MHCI06024-R22M-R8A	0.22	20	100	21	34	3.2
MHCI06024-R33M-R8A	0.33	20	100	18	24.5	4.1
MHCI06024-R47M-R8A	0.47	20	100	15	22	5.1
MHCI06024-1R0M-R8A	1.0	20	100	9	16	13.5
MHCI06024-1R5M-R8A	1.5	20	100	9	15	20
MHCI06024-2R2M-R8A	2.2	20	100	7	14	28
MHCI06024-4R7M-R8A	4.7	20	100	5	10	50
MHCI06024-100M-R8A	10	20	100	3.1	4.0	101
MHCI06024-150M-R8A	15	20	100	2.5	3.3	160

- I_{rms} DC current (A) that will cause an approximate ΔT of 40°C
- I_{sat} DC current (A) that will cause L to drop approximately 30%
- Tolerance : M= $\pm 20\%$
- L : WK 3260B, 100KHz 0.5V
- R_{dc} : CHEN HWA 502
- Operating temperature range from -55°C to 125°C. (Including self - temperature rise)

Test Instruments : WK3260B Impedance / Material Analyzer

Inductance vs DC Current

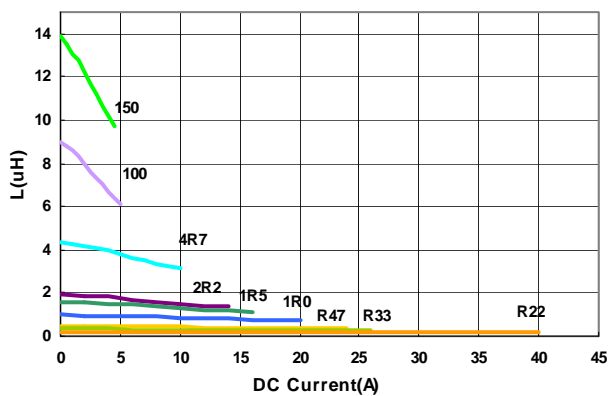

Temperature Change v.s DC Current

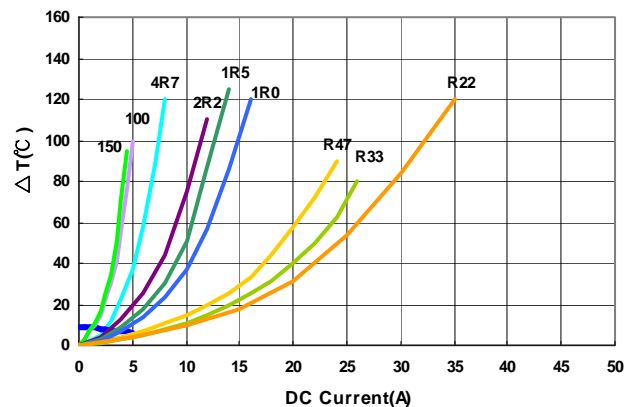

Electrical Characteristics

Part Number	Inductance (μH)	Tolerance ($\pm\%$)	Test Frequency (KHz)	I _{rms} (A)Typ.	I _{sat} (A)Typ.	RDC ($\text{m}\Omega$)Max
MHCI06030-R10M-R8	0.10	20	100	37	45	1.5
MHCI06030-R22M-R8	0.22	20	100	23	40	2.8
MHCI06030-R33M-R8	0.33	20	100	20	33	4.2
MHCI06030-R47M-R8	0.47	20	100	16.5	27	5.5
MHCI06030-R68M-R8	0.68	20	100	15	24	6.3
MHCI06030-R82M-R8	0.82	20	100	13	23	8.0
MHCI06030-1R0M-R8	1.0	20	100	12	22	10
MHCI06030-1R5M-R8	1.5	20	100	9.5	18	15
MHCI06030-2R2M-R8	2.2	20	100	8.5	14	20
MHCI06030-3R3M-R8	3.3	20	100	6.0	12	35
MHCI06030-4R7M-R8	4.7	20	100	5.5	9	40
MHCI06030-6R8M-R8	6.8	20	100	4.5	8	60
MHCC06030-8R2M-R7	8.2	20	100	4.5	6	60
MHCC06030-100M-R7	10	20	100	4.0	5.5	68

- I_{rms} DC current (A) that will cause an approximate ΔT of 40°C
- I_{sat} DC current (A) that will cause L to drop approximately 30%
- Tolerance : M= $\pm 20\%$
- L : WK 3260B, 100KHz 0.5V
- Rdc : CHEN HWA 502
- Operating temperature range from -55°C to 125°C. (Including self - temperature rise)

Test Instruments : WK3260B Impedance / Material Analyzer

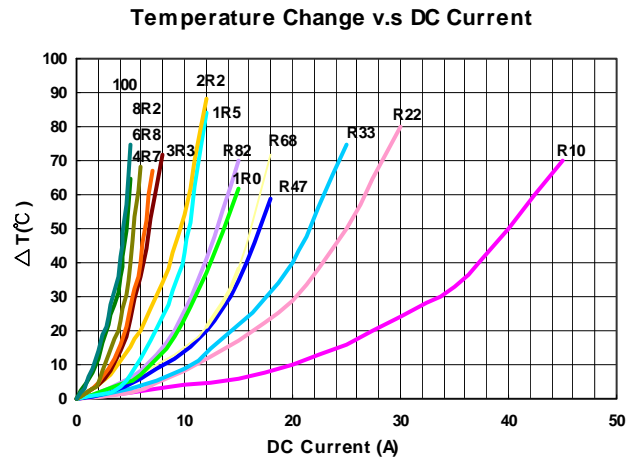
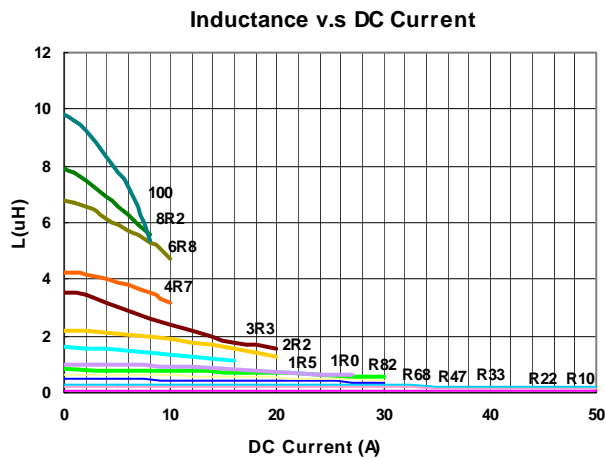

Electrical Characteristics

Part Number	Inductance (μH)	Tolerance ($\pm\%$)	Test Frequency (KHz)	I _{rms} (A)Typ.	I _{sat} (A)Typ.	RDC ($\text{m}\Omega$)Max
MHCI06030-R10M-R8A	0.10	20	100	32.5	60	1.7
MHCI06030-R22M-R8A	0.22	20	100	23	34	3.0
MHCI06030-R68M-R8A	0.68	20	100	16	17	5.3
MHCI06030-1R0M-R8A	1.0	20	100	12	15	7.4
MHCI06030-1R2M-R8A	1.2	20	100	10	14	10
MHCI06030-1R5M-R8A	1.5	20	100	10	14	12.1
MHCI06030-2R2M-R8A	2.2	20	100	8	10	15
MHCI06030-3R3M-R8A	3.3	20	100	6.5	9.5	22
MHCI06030-4R7M-R8A	4.7	20	100	5.5	6.5	33
MHCI06030-6R8M-R8A	6.8	20	100	4.5	6	50
MHCI06030-100M-R8A	10	20	100	4	5.5	68

- I_{rms} DC current (A) that will cause an approximate ΔT of 40°C
- I_{sat} DC current (A) that will cause L to drop approximately 30%
- Tolerance : M= $\pm 20\%$
- L : WK 3260B, 100KHz 0.5V
- R_{dc} : CHEN HWA 502
- Operating temperature range from -55°C to 125°C. (Including self - temperature rise)

Test Instruments : WK3260B Impedance / Material Analyzer

Inductance vs DC Current

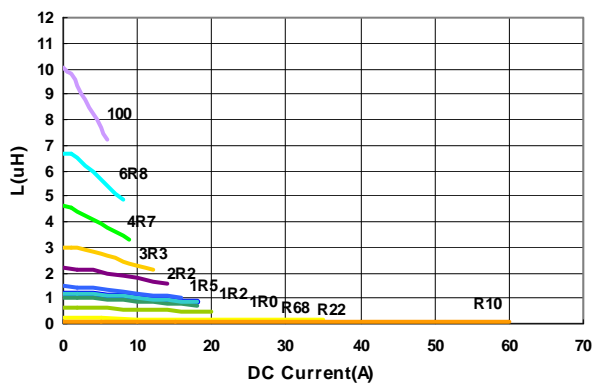

Temperature Change v.s DC Current

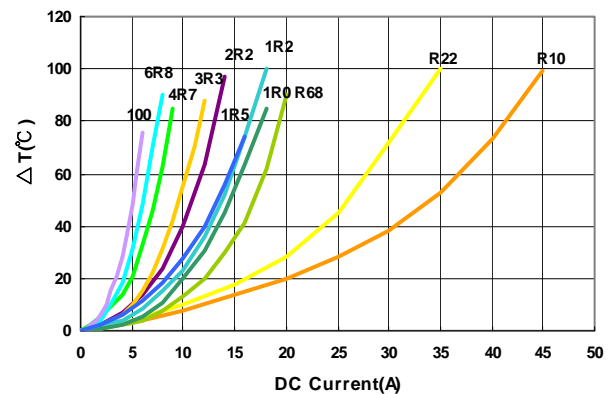

Electrical Characteristics

Part Number	Inductance (μH)	Tolerance ($\pm\%$)	Test Frequency (KHz)	I _{rms} (A)Typ.	I _{sat} (A)Typ.	RDC ($\text{m}\Omega$)Max
MHCC10030-R33M-R7A	0.33	20	100	23	32	1.6
MHCC10030-1R0M-R7A	1.0	20	100	15	21	6.0

- I_{rms} current (A) that will cause an approximate ΔT of 40°C
- I_{sat} current (A) that will cause L to drop approximately 30%
- Tolerance : M= $\pm 20\%$
- L : WK 3260B, 100KHz 0.5V
- R_{dc} : CHEN HWA 502
- Operating temperature range from -55°C to 125°C. (Including self - temperature rise)

Test Instruments : WK3260B Impedance / Material Analyzer

Inductance vs DC Current

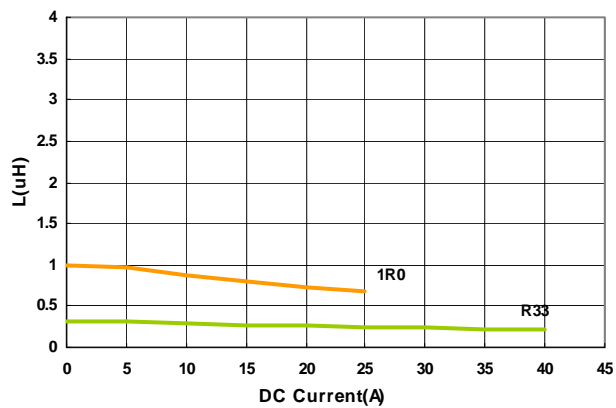

Temperature Change v.s DC Current

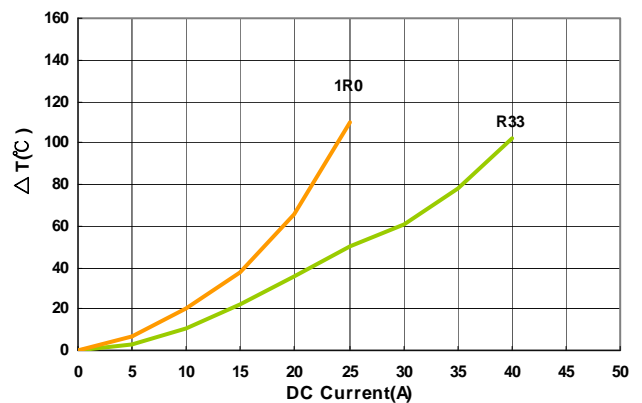

Molding Power Choke – MHCC/MHCI Series

Electrical Characteristics

Part Number	Inductance (μH)	Tolerance ($\pm\%$)	Test Frequency (KHz)	I _{rms} (A)Typ.	I _{sat} (A)Typ.	RDC ($\text{m}\Omega$)Max
MHCC10040-R22M-R7	0.22	20	100	35	45	0.6
MHCC10040-R36M-R7	0.36	20	100	34	42	1.2
MHCC10040-R47M-R7	0.47	20	100	33	38	1.2
MHCC10040-R56M-R7	0.56	20	100	27	32	1.55
MHCC10040-R68M-R7	0.68	20	100	27	30	1.55
MHCC10040-1R0M-R7	1.0	20	100	20	26	3.1
MHCC10040-1R5M-R7	1.5	20	100	16	22	4.2
MHCC10040-1R8M-R7	1.8	20	100	15.3	16	5
MHCC10040-2R2M-R7	2.2	20	100	14	16	7
MHCC10040-3R3M-R7	3.3	20	100	11	12	13.2
MHCI10040-4R7M-R8	4.7	20	100	10	13	16.5
MHCC10040-6R8M-R7	6.8	20	100	6	10	25
MHCC10040-8R2M-R7	8.2	20	100	6	9	30
MHCC10040-100M-R7	10	20	100	6.5	7	30
MHCC10040-150M-R7	15	20	100	5	6	53
MHCC10040-220M-R7	22	20	100	4.5	4.5	64

- I_{rms} DC current (A) that will cause an approximate ΔT of 40°C
- I_{sat} DC current (A) that will cause L to drop approximately 30%
- Tolerance : M= $\pm 20\%$
- L : WK 3260B, 100KHz 0.5V
- R_{dc} : CHEN HWA 502
- Operating temperature range from -55°C to 125°C. (Including self - temperature rise)

Test Instruments : WK3260B Impedance / Material Analyzer

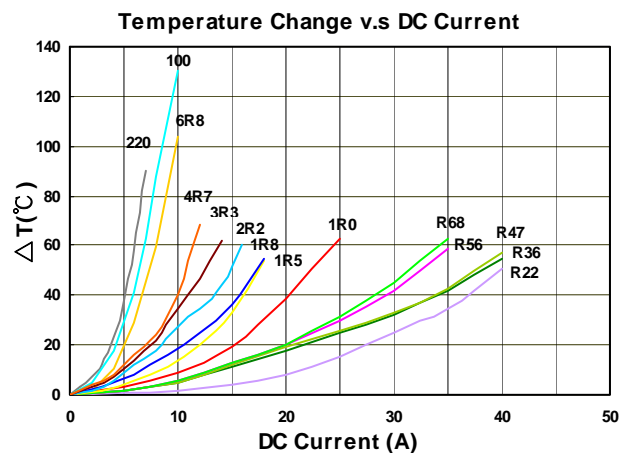
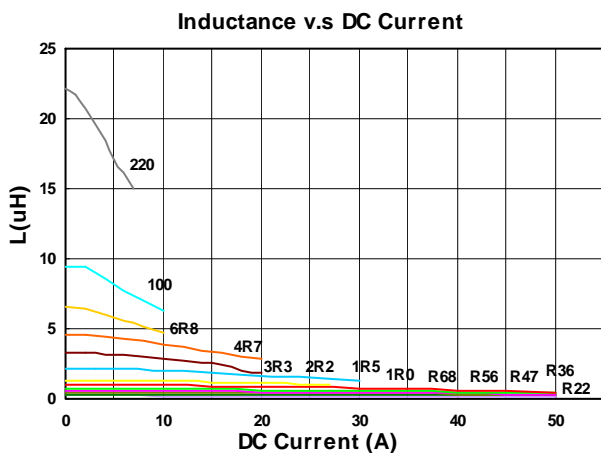

Electrical Characteristics

Part Number	Inductance (μH)	Tolerance ($\pm\%$)	Test Frequency (KHz)	I _{rms} (A)Typ.	I _{sat} (A)Typ.	RDC ($\text{m}\Omega$)Max
MHCC12035-1R0M-R7	1.0	20	100	27	28	2.5

- I_{rms} DC current (A) that will cause an approximate ΔT of 40°C
- I_{sat} DC current (A) that will cause L to drop approximately 20%
- Tolerance : M= $\pm 20\%$
- L : WK 3260B, 100KHz 0.5V
- R_{dc} : CHEN HWA 502
- Operating temperature range from -55°C to 125°C. (Including self - temperature rise)

Test Instruments : WK3260B Impedance / Material Analyzer

Inductance v.s DC Current

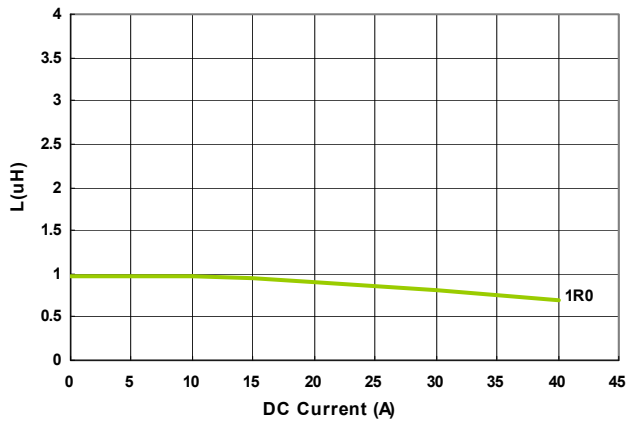

Temperature Change v.s DC Current

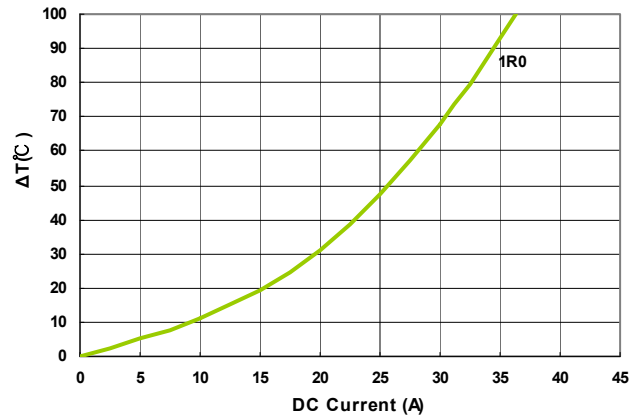

Electrical Characteristics

Part Number	Inductance (μH)	Tolerance ($\pm\%$)	Test Frequency (KHz)	I _{rms} (A)Typ.	I _{sat} (A)Typ.	RDC ($\text{m}\Omega$)Max
MHCC12050-R47M-R7	0.47	20	100	37	46	1.2
MHCC12050-1R0M-R7	1.0	20	100	29	37	2.5
MHCC12050-4R7M-R7	4.7	20	100	11	16	11.5
MHCC12050-6R8M-R7	6.8	20	100	9	14	22
MHCC12050-100M-R7	10	20	100	7	13	35

- I_{rms} current (A) that will cause an approximate ΔT of 40°C
- I_{sat} current (A) that will cause L to drop approximately 30%
- Tolerance : M= $\pm 20\%$
- L : WK 3260B, 100KHz 0.5V
- R_{dc} : CHEN HWA 502
- Operating temperature range from -55°C to 125°C. (Including self - temperature rise)

Test Instruments : WK3260B Impedance / Material Analyzer

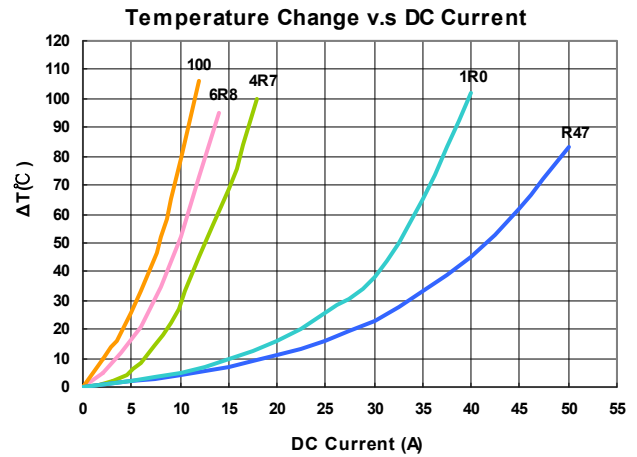
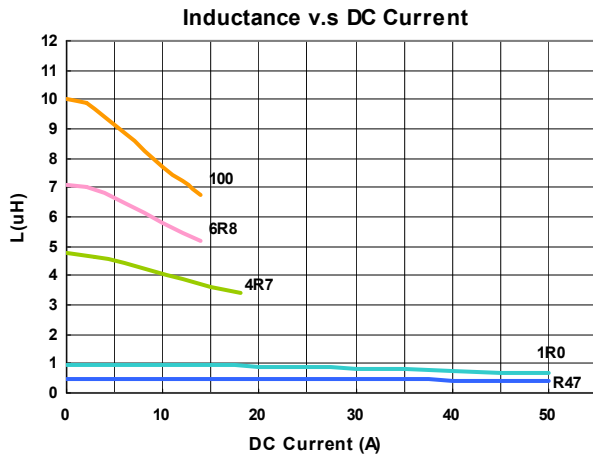

Electrical Characteristics

Part Number	Inductance (μH)	Tolerance ($\pm\%$)	Test Frequency (KHz)	I _{rms} (A)Typ.	I _{sat} (A)Typ.	RDC ($\text{m}\Omega$)Max
MHCC12060-100M-R7A	10	20	100	10	12.5	20.7
MHCC12060-150M-R7A	15	20	100	6.0	9.0	29.0
MHCC12060-220M-R7A	22	20	100	5.0	7.5	39.5
MHCC12060-330M-R7A	33	20	100	4.0	6.0	75
MHCC12060-680M-R7A	68	20	100	3.0	4.5	140

- I_{rms} current (A) that will cause an approximate ΔT of 40°C
- I_{sat} current (A) that will cause L to drop approximately 30%
- Tolerance : M= $\pm 20\%$
- L : WK 3260B, 100KHz 0.5V
- Rdc : CHEN HWA 502
- Operating temperature range from -55°C to 125°C . (Including self - temperature rise)

Test Instruments : WK3260B Impedance / Material Analyzer

Inductance vs DC Current

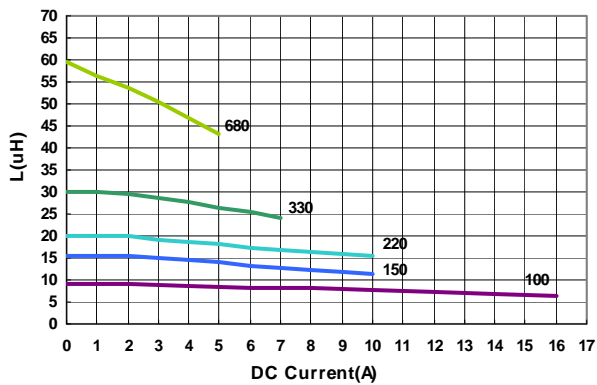

Temperature Change v.s DC Current

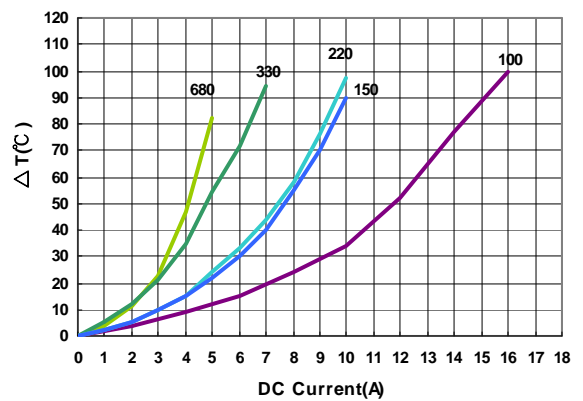

Packaging Specifications

Tape Dimensions

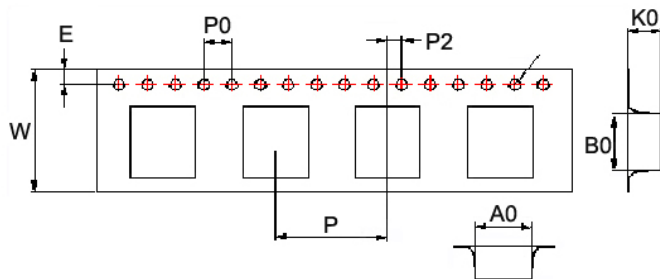

Tape Material

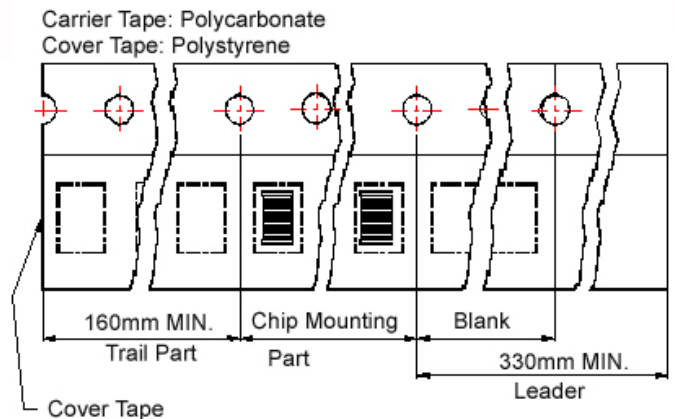

Reel Dimensions

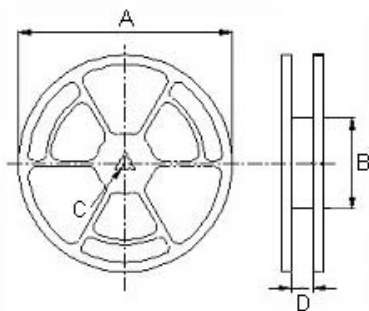

Dimensions in mm

TYPE	Tape Dimensions									Reel Dimensions				Quantity
	A0	B0	K0	D	E	W	P	P0	P2	A	B	C	D	PCS / REEL
04012	4.6	5.0	1.5	1.55	1.75	12	8	4	2	330	100	13	13.4	2000
04015	4.4	4.9	1.8	1.55	1.75	12	8	4	2	330	100	13	13.4	2000
04020	4.3	4.9	2.4	1.55	1.75	12	8	4	2	330	100	13	13.4	2000
05012	5.9	6.2	1.5	1.55	1.75	16	12	4	2	330	100	13	17.4	1000
05015	5.9	6.2	1.9	1.55	1.75	16	12	4	2	330	100	13	17.4	1000
05018	5.9	6.2	2.2	1.55	1.75	16	12	4	2	330	100	13	17.4	1000
05020	5.9	6.2	2.4	1.55	1.75	16	12	4	2	330	100	13	17.4	1000
05030	5.9	6.2	3.4	1.55	1.75	16	12	4	2	330	100	13	17.4	1000
06012	6.9	7.6	1.6	1.55	1.75	16	12	4	2	330	100	13	17.4	1000
06015	6.9	7.6	1.9	1.55	1.75	16	12	4	2	330	100	13	17.4	1000
06018	6.9	7.6	2.2	1.55	1.75	16	12	4	2	330	100	13	17.4	1000
06024	6.9	7.6	2.9	1.55	1.75	16	12	4	2	330	100	13	17.4	1000
06030	6.9	7.6	3.4	1.55	1.75	16	12	4	2	330	100	13	17.4	1000
10030	10.6	11.7	3.25	1.55	1.75	24	16	4	2	330	100	13	24.4	500
10040	10.6	11.7	4.25	1.55	1.75	24	16	4	2	330	100	13	24.4	500
12035	13	14	3.7	1.55	1.75	24	16	4	2	330	100	13	24.4	500
12050	13	14	5.25	1.55	1.75	24	16	4	2	330	100	13	24.4	500
12060	13	14	6.25	1.55	1.75	24	16	4	2	330	100	13	24.4	500

