

SOT-363

Features

- ◇ Fast switching speed
- ◇ Low forward voltage drop
- ◇ Moisture sensitivity level 1
- ◇ Matte Tin(Sn) lead finish with Nickel(Ni) underplate
- ◇ Pb free version and RoHS compliant
- ◇ Green compound (Halogen free) with suffix "G" on packing code and prefix "G" on date code



Mechanical Data

- ◇ Case :SOT-363 small outline plastic package
- ◇ Terminal: Matte tin plated, lead free., solderable per MIL-STD-202, method 208 guaranteed
- ◇ High temperature soldering guaranteed: 260°C/10s
- ◇ Weight : 0.006 gram (approximately)

Ordering Information (example)

Part No.	Package	Packing	Packing code	Packing code (Green)	Manufacture code
BAT54T-G	SOT-363	3K / 7" Reel	RF	RFG	D0

Note : Detail please see "Ordering Information(detail, example)" below.

Maximum Ratings and Electrical Characteristics

Rating at 25°C ambient temperature unless otherwise specified.

Maximum Ratings

Parameter	Symbol	Value	Units
Peak Repetitive Peak Reverse Voltage	V_{RRM}	30	V
Working Peak Reverse Voltage	V_{RWM}		
DC Reverse Voltage	V_R		
Forward Continuous Current	I_F	200	mA
Repetitive Peak Forward Current	I_{FRM}	300	mA
Forward Surge Current @ $t < 1.0$ s	I_{FSM}	600	mA
Power Dissipation	P_d	200	mW
Thermal resistance, junction to ambient air	$R_{\theta JA}$	625	°C/W
Operating and Storage temperature	T_J, T_{STG}	-65 to 150	°C

Electrical Characteristics

Parameter	Symbol	Min	Max	Units
Reverse Breakdown Voltage	$V_{(BR)}$	30	--	V
Forward Voltage	$I_R=100\mu A$	--	0.24	V
	$I_F=0.1mA$	--	0.32	
	$I_F=1mA$	--	0.40	
	$I_F=10mA$	--	0.50	
	$I_F=30mA$	--	1	
Reverse current	I_R	--	2.0	μA
Total Capacitance	C_T	--	10	pF
Reverse Recovery Time	t_{rr}	--	5.0	nS

RATINGS AND CHARACTERISTIC CURVES

Fig. 1 Forward Characteristics

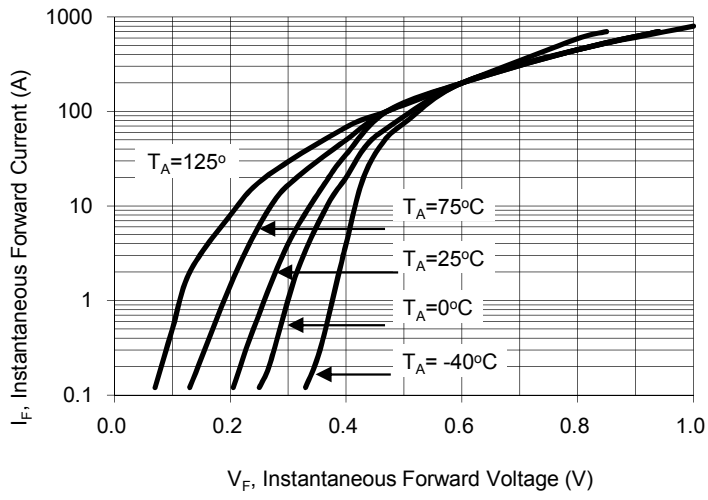

Fig. 2 Typical Reverse Characteristics

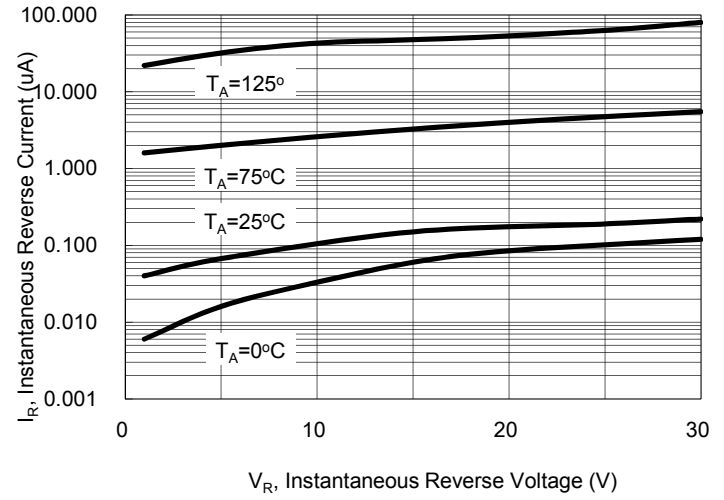

Fig. 3 Capacitance Between Terminals Characteristics

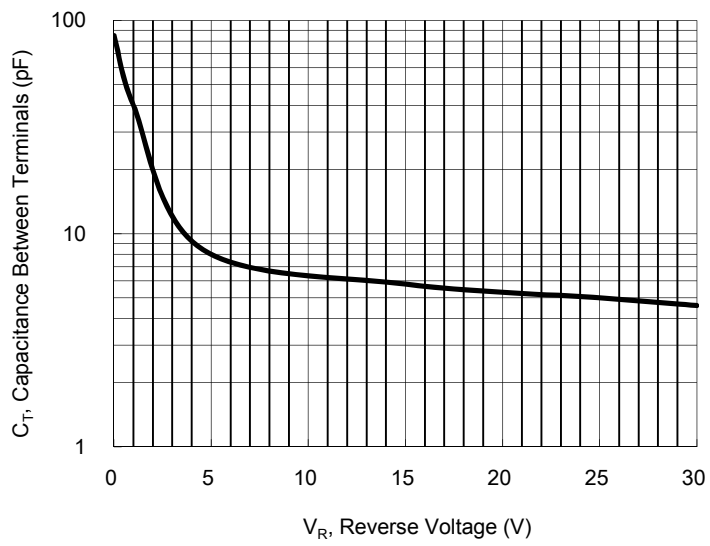
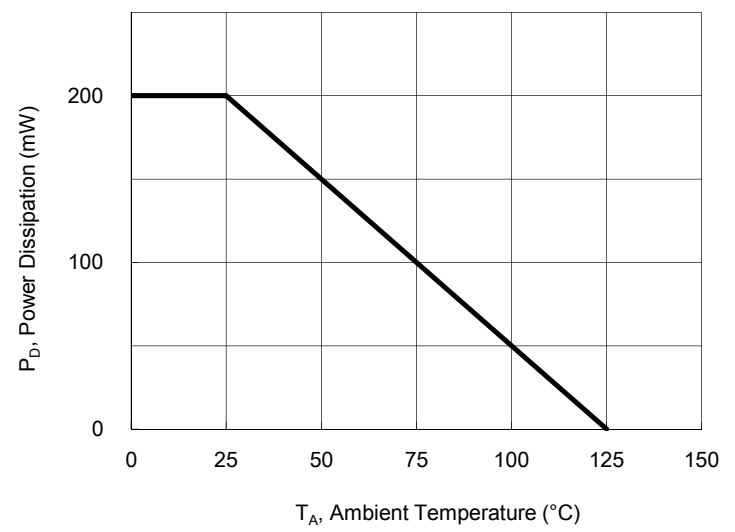

Fig. 4 Power Derating Curve



Ordering information (Detail, example)

Part No.	Package	Packing	Packing code	Packing code (Green)	Manufacture code
BAT54xx-G (Note 1)	SOT-363	3K / 7" Reel	RF	RFG	(Note 2)
BAT54T-G	SOT-363	3K / 7" Reel	RF	RFG	
BAT54T-G	SOT-363	3K / 7" Reel	RF	RFG	D0

Note 1 : "xx" is Device Code from "T" thru "BR"

Note 2 : Manufacture special control, if empty means no special control requirement.

Tape & Reel specification

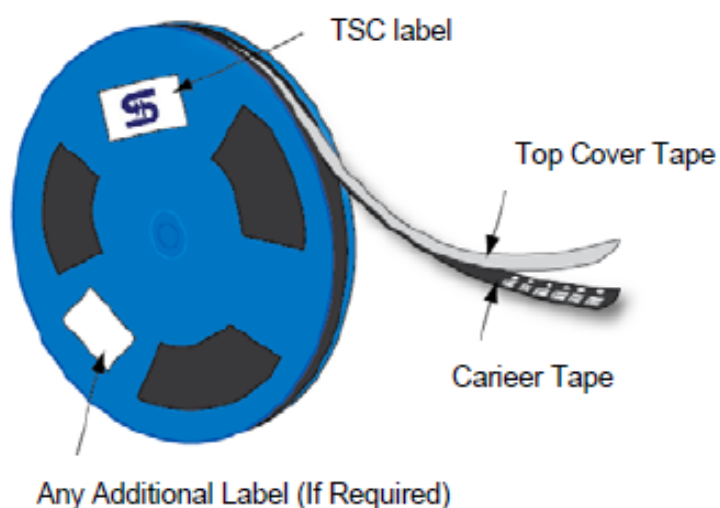

Item	Symbol	Dimension(mm)
Carrier width	A	3.15 ±0.10
Carrier length	B	2.77 ±0.10
Carrier depth	C	1.22 ±0.10
Sprocket hole	d	1.50 ± 0.10
Reel outside diameter	D	178 ± 1
Reel inner diameter	D1	55 Min
Feed hole width	D2	13.0 ± 0.20
Sprocket hole position	E	1.75 ±0.10
Punch hole position	F	3.50 ±0.05
Sprocket hole pitch	P0	4.00 ±0.10
Embossment center	P1	2.00 ±0.05
Overall tape thickness	T	0.229 ±0.013
Tape width	W	8.10 ±0.20
Reel width	W1	12.30 ±0.20

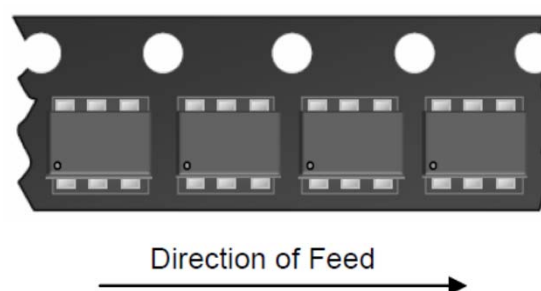
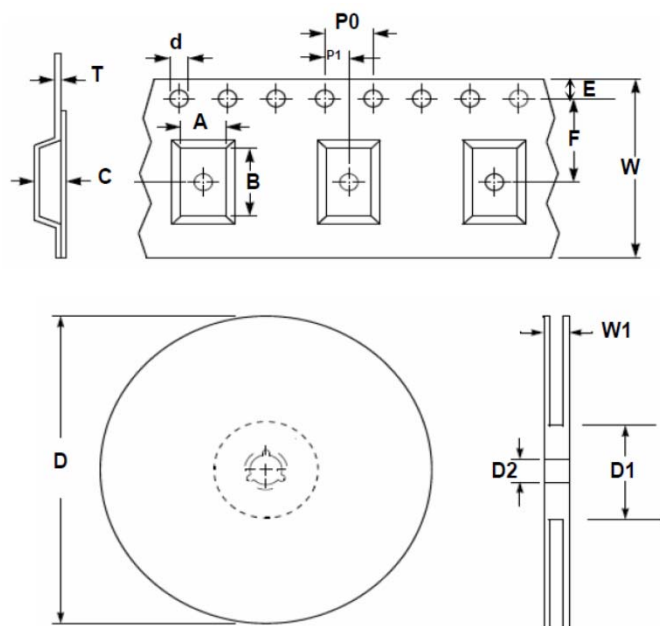

Dimensions

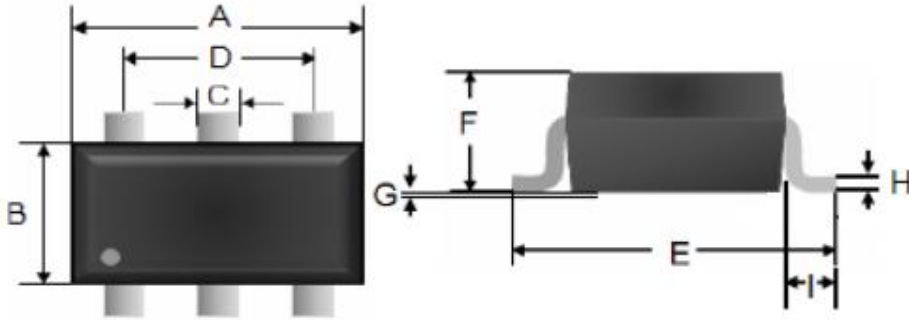

DIM.	Unit(mm)		Unit(inch)	
	Min	Max	Min	Max
A	1.80	2.20	0.071	0.087
B	1.15	1.35	0.045	0.053
C	0.15	0.35	0.006	0.014
D	1.20	1.40	0.047	0.055
E	2.15	2.45	0.085	0.096
F	0.90	1.10	0.035	0.043
G	-	0.1	-	0.004
H	0.05	0.15	0.002	0.006
I	0.25	-	0.010	-

Suggested PAD Layout

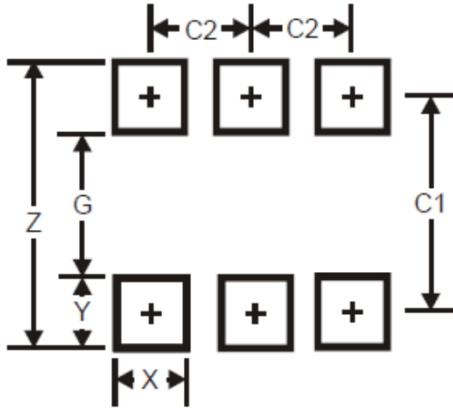

Dimensions	Value (in mm)
Z	3.20
G	1.60
X	0.55
Y	0.80
C1	2.40
C2	0.95

Pin Configuration

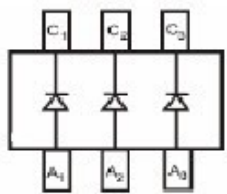

BAT54T

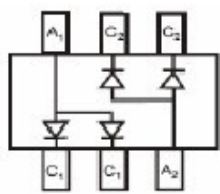

BAT54AD

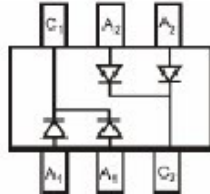

BAT54CD

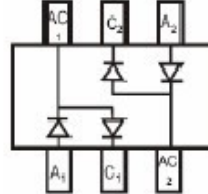

BAT54SD

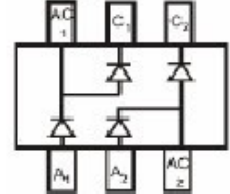

BAT54BR

Marking Code

Part NO.	Marking
BAT54T-G	KLA
BAT54AD-G	KL6
BAT54CD-G	KL7
BAT54SD-G	KL8
BAT54BR-G	KLB