

SAW FILTER FOR GPS

Murata part number :SAFEB1G57FA0F00

Package Dimensions

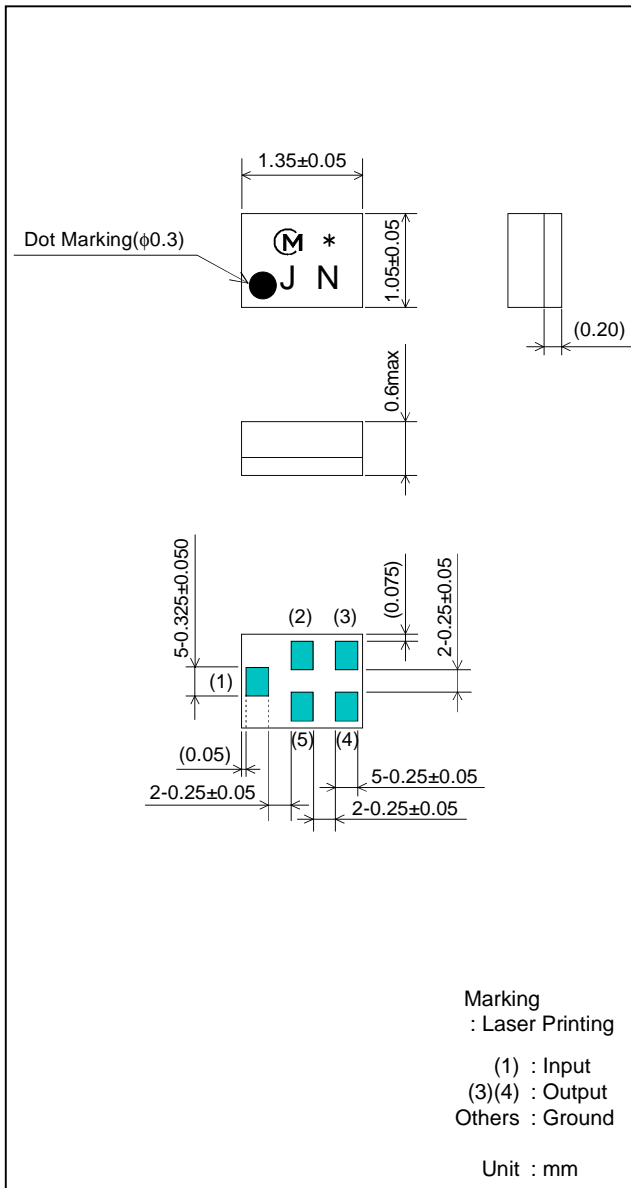

Specification

Item	Specification		
	-30 to 85°C	25±2°C	typ.
Nominal Center Frequency(fc)	1575.5MHz		
Insertion Loss (1574 to 1577MHz)	1.6 dB max.	1.5 dB max.	1.3 dB
Absolute Attenuation			
1) DC to 824 MHz	45 dB min.	45 dB min.	53 dB
2) 824 to 843 MHz	45 dB min.	45 dB min.	53 dB
3) 843 to 870 MHz	45 dB min.	45 dB min.	53 dB
4) 898 to 925 MHz	45 dB min.	45 dB min.	53 dB
5) at 1355.25MHz	40 dB min.	40 dB min.	56 dB
6) 1429 to 1501 MHz	30 dB min.	30 dB min.	33 dB
7) 1501 to 1525 MHz	30 dB min.	30 dB min.	35 dB
8) at 1525.42MHz	30 dB min.	30 dB min.	45 dB
9) at 1625.42MHz	29 dB min.	29 dB min.	31 dB
10) 1749 to 1785 MHz	33 dB min.	33 dB min.	40 dB
11) 1893 to 1920 MHz	38 dB min.	38 dB min.	45 dB
12) 1920 to 1940 MHz	40 dB min.	40 dB min.	47 dB
13) 1940 to 1980 MHz	40 dB min.	40 dB min.	47 dB
14) 1980 to 3000 MHz	30 dB min.	30 dB min.	38 dB
Ripple Deviation (1574 to 1577MHz)	0.6dB max.	0.5dB max.	0.2 dB
VSWR (1574 to 1577MHz)	1.7 max.	1.7 max.	1.2
Amplitude Balance (1574 to 1577MHz)	±1.0 dB max.	±1.0 dB max.	+0.5 dB
Phase Balance (1574 to 1577MHz)	180±8 deg.	180±8 deg.	180.0+3.5 deg.
Input Impedance (nominal)	50Ω		
Output Impedance (nominal)	100Ω		
Input Signal Level	20mW (+13dBm), 2000 hours		

SAW FILTER FOR GPS

Murata part number :SAFEB1G57FA0F00

Frequency Performance

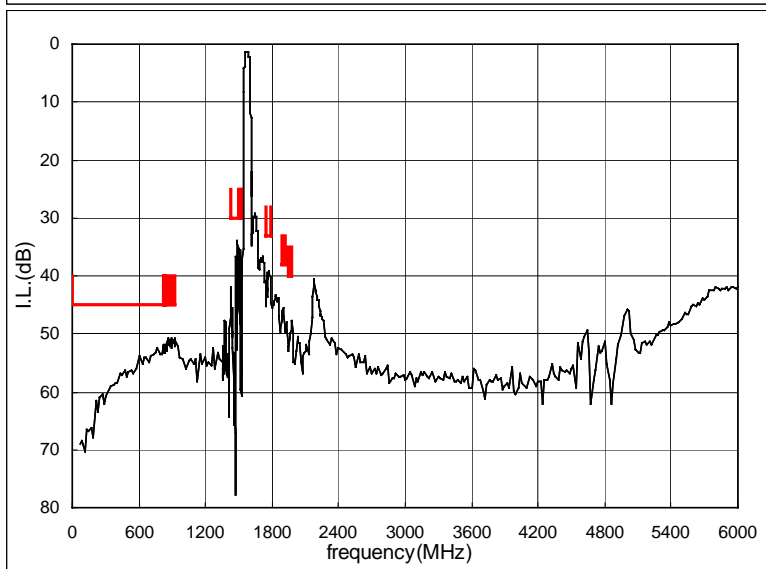
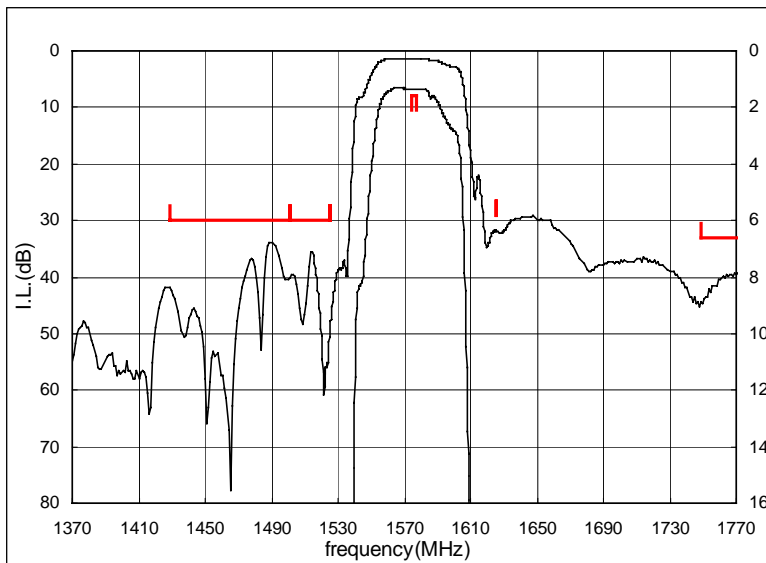

Amplitude balance

Phase balance

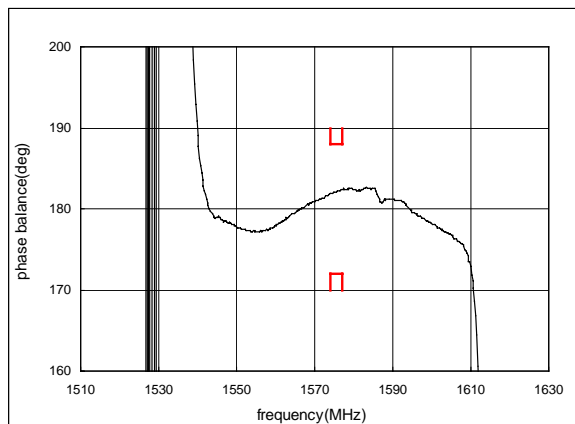
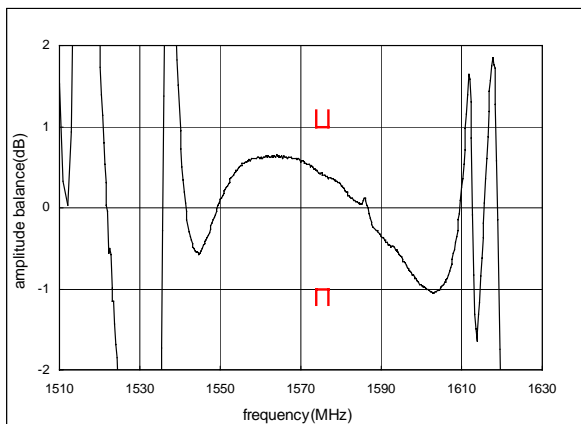

SAW FILTER FOR GPS

Murata part number :SAFEB1G57FA0F00

■ Dimensions of Carrier Tape

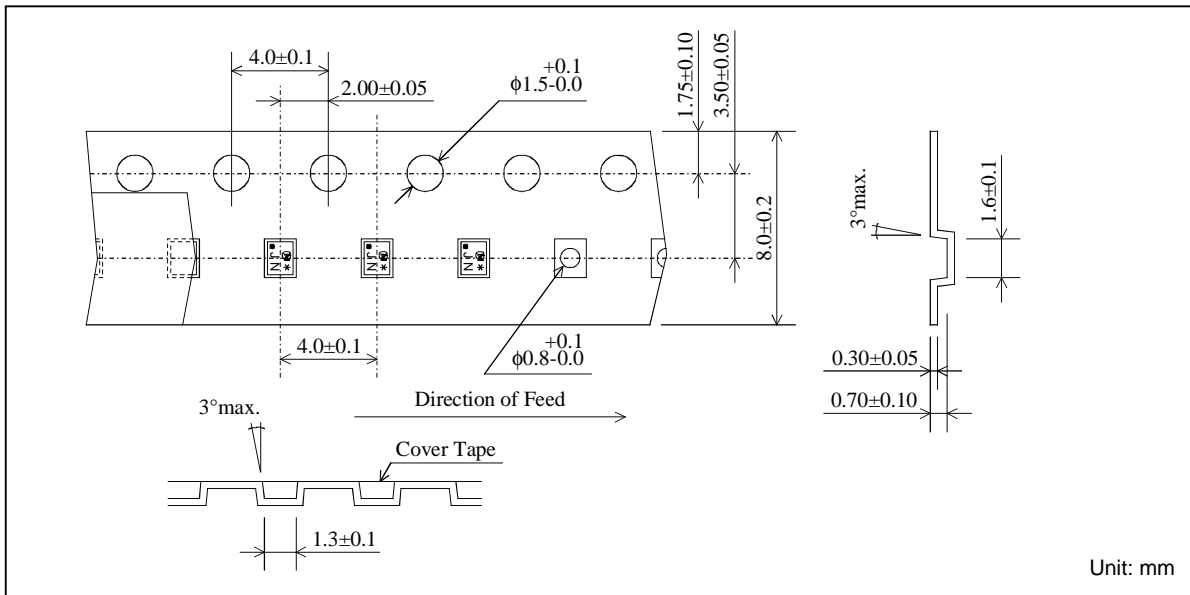

■ Dimensions of Tape

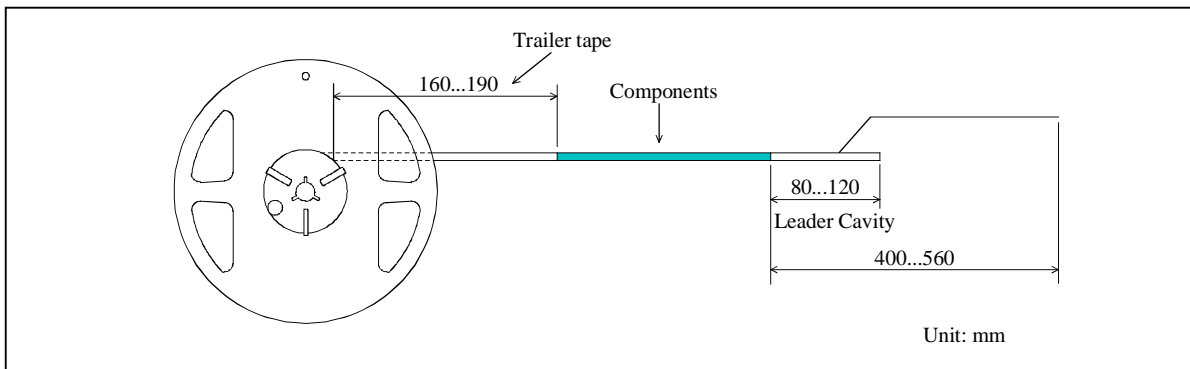

■ Dimensions of Reel

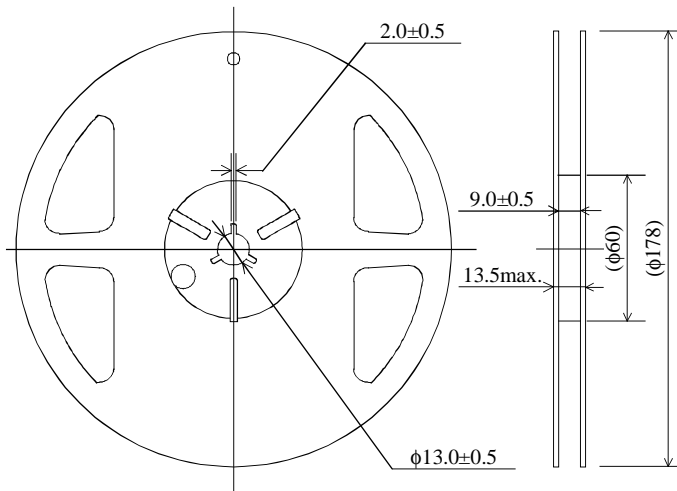

SAFEB1G57FA0F00R14 ... 4000pcs/reel
 SAFEB1G57FA0F00R12 ... 2000pcs/reel

SAW FILTER FOR GPS

Murata part number :SAFEB1G57FA0F00

Recommended Land Pattern

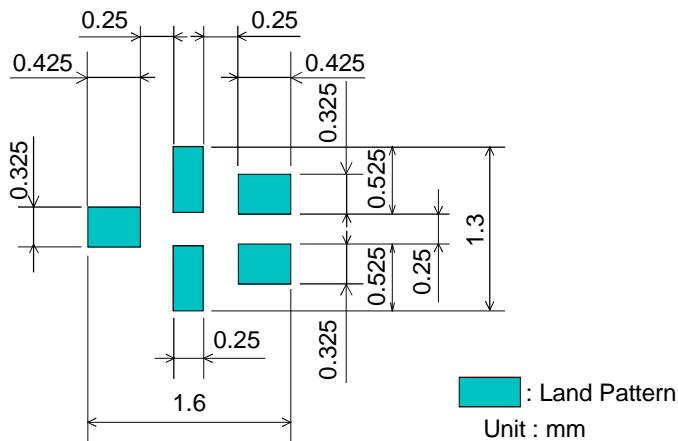

Test Circuit

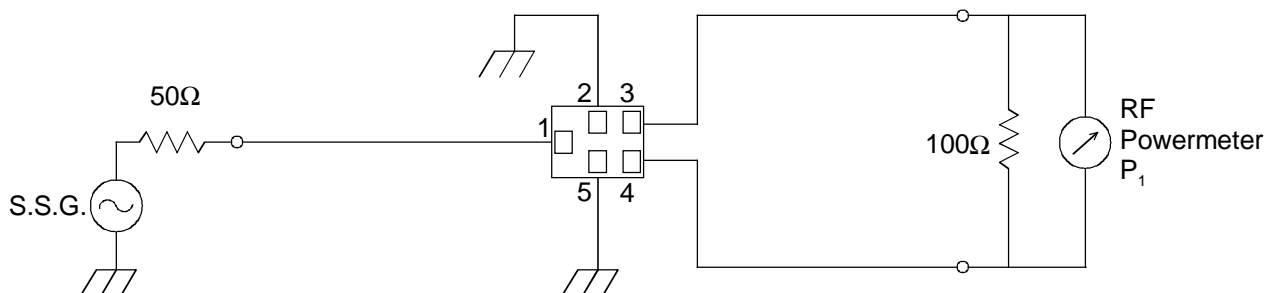

- This PDF Datasheet is downloaded from the website of Murata Manufacturing Co., Ltd. Therefore, it's specifications are subject to change or our products in it may be discontinued without advance notice. Please check with our sales representatives or product engineers before ordering.
- This PDF Datasheet has only typical specifications because there is no space for detailed specifications. Therefore, please approve our product specifications or transact the approval sheet for product specifications before ordering.