



CPH6021 — NPN Epitaxial Planar Silicon Transistor

High-Frequency Low-Noise Amplifier

Features

- Low-noise use : NF=1.2dB typ (f=1GHz)
- High cut-off frequency : $f_T=10\text{GHz}$ typ ($V_{CE}=5\text{V}$)
- High gain : $|S_{21e}|^2=14\text{dB}$ typ (f=1GHz)
- Halogen free compliance

Specifications

Absolute Maximum Ratings at $T_a=25^\circ\text{C}$

Parameter	Symbol	Conditions	Ratings	Unit
Collector-to- Base Voltage	V_{CBO}		20	V
Collector-to-Emitter Voltage	V_{CEO}		12	V
Emitter-to-Base Voltage	V_{EBO}		2	V
Collector Current	I_C		100	mA
Collector Dissipation	P_C	When mounted on ceramic substrate (250mm ² ×0.8mm)	700	mW
Junction Temperature	T_j		150	°C
Storage Temperature	T_{stg}		-55 to +150	°C

Package Dimensions

unit : mm (typ)
7018A-002

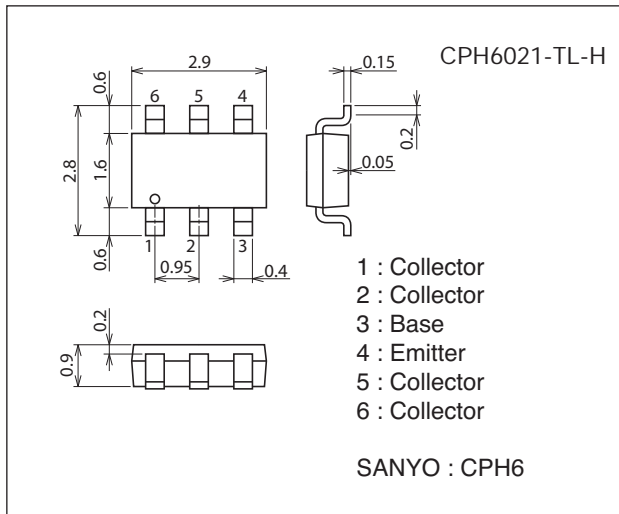

Product & Package Information

- Package : CPH6
- JEITA, JEDEC : SC-74, SOT-26, SOT-457
- Minimum Packing Quantity : 3,000 pcs./reel

Packing Type: TL

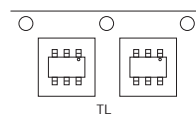

Marking

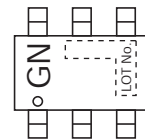

Electrical Connection

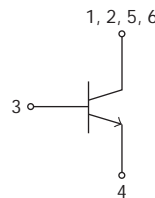

CPH6021

Electrical Characteristics at Ta=25°C

Parameter	Symbol	Conditions	Ratings			Unit
			min	typ	max	
Collector Cutoff Current	I_{CBO}	$V_{CB}=5V, I_E=0A$			1.0	μA
Emitter Cutoff Current	I_{EBO}	$V_{EB}=1V, I_C=0A$			1.0	μA
DC Current Gain	h_{FE}	$V_{CE}=5V, I_C=50mA$	60		150	
Gain-Bandwidth Product	f_T	$V_{CE}=5V, I_C=30mA$	8	10		GHz
Forward Transfer Gain	$ S_{21e} ^2$	$V_{CE}=5V, I_C=30mA, f=1GHz$	10	14		dB
Noise Figure	NF	$V_{CE}=5V, I_C=10mA, f=1GHz$		1.2	1.8	dB

Note) Pay attention to handling since it is liable to be affected by static electricity due to the high-frequency process adopted.

Ordering Information

Device	Package	Shipping	memo
CPH6021-TL-H	CPH6	3,000pcs./reel	Pb Free and Halogen Free

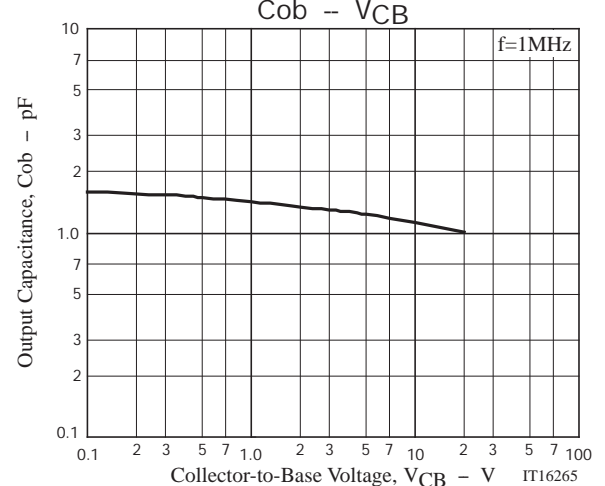
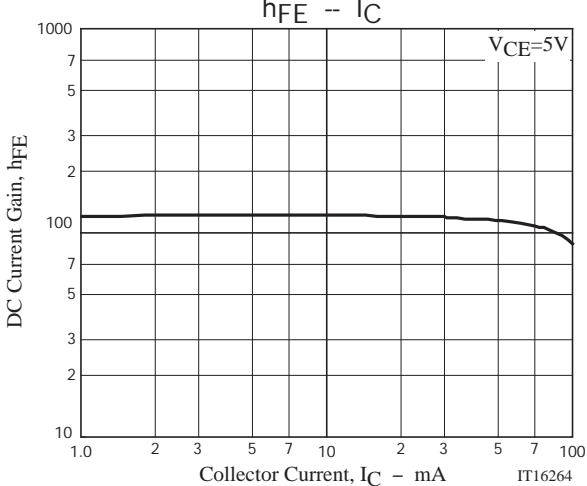
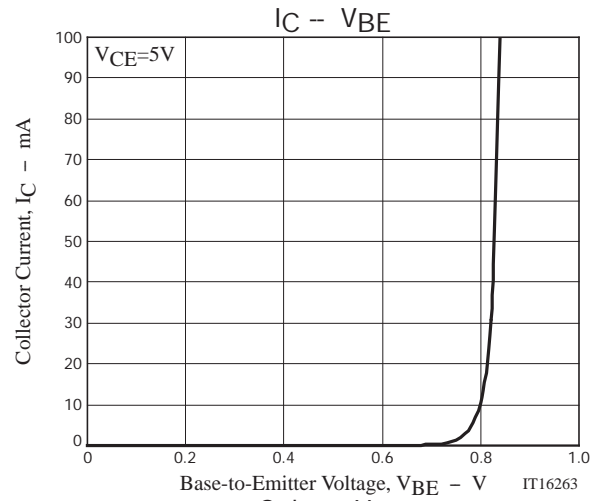
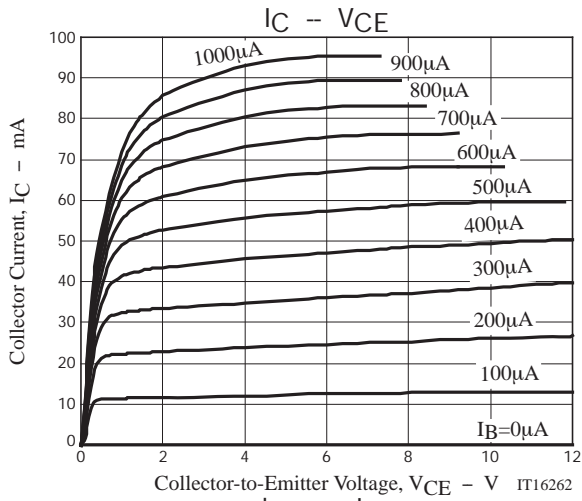

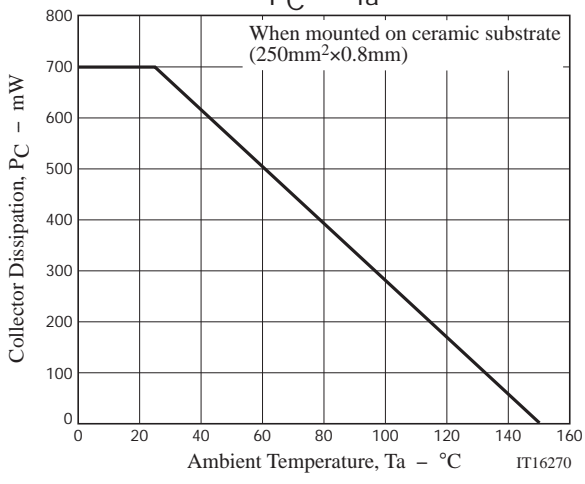
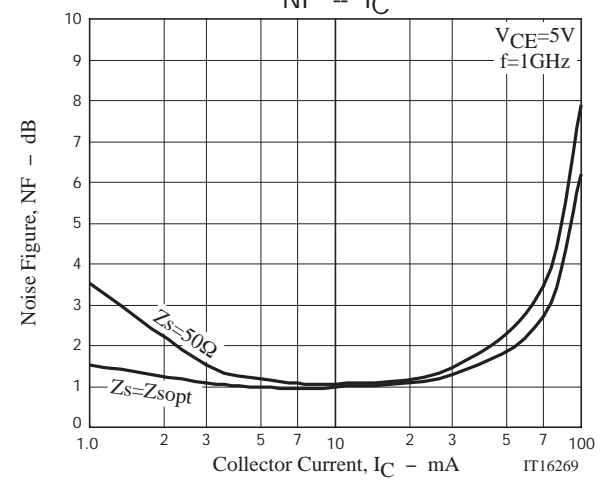
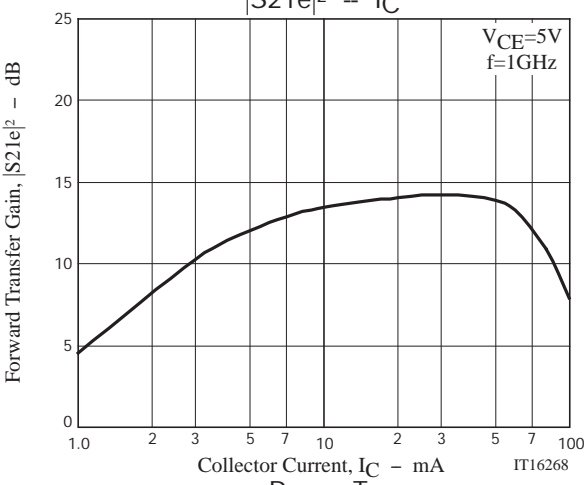
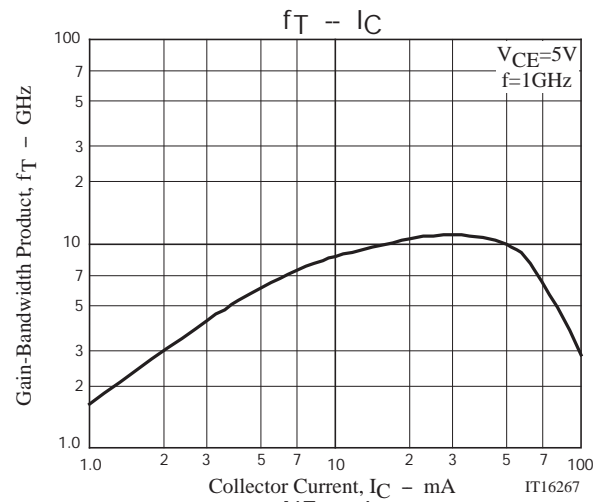
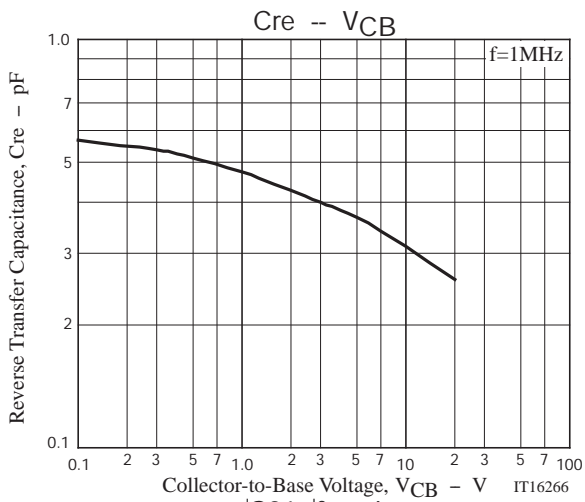

CPH6021

S Parameters (Common emitter)

V_{CE}=3V, I_C=10mA

Freq(MHz)	S ₁₁	∠S ₁₁	S ₂₁	∠S ₂₁	S ₁₂	∠S ₁₂	S ₂₂	∠S ₂₂
100	0.758	-26.8	14.284	149.0	0.021	74.1	0.878	-24.0
200	0.630	-56.2	13.720	131.4	0.033	66.6	0.711	-38.2
300	0.503	-82.5	12.164	116.0	0.044	65.4	0.593	-46.0
400	0.414	-103.1	10.315	104.5	0.053	65.8	0.512	-51.3
500	0.368	-117.9	8.649	96.7	0.062	67.0	0.457	-55.3
600	0.341	-129.4	7.360	90.8	0.072	68.0	0.419	-58.7
700	0.326	-138.7	6.370	86.0	0.081	68.6	0.391	-61.8
800	0.313	-147.1	5.629	81.7	0.091	69.2	0.370	-64.6
900	0.307	-154.2	5.036	78.0	0.101	69.2	0.353	-67.3
1000	0.302	-160.2	4.556	74.7	0.112	69.2	0.342	-69.9
1200	0.299	-170.7	3.832	68.6	0.133	68.5	0.325	-75.2
1400	0.298	-179.6	3.316	63.1	0.155	67.4	0.316	-80.5
1600	0.301	172.7	2.931	57.9	0.177	66.0	0.312	-86.0
1800	0.305	165.8	2.634	53.0	0.199	64.4	0.311	-91.4
2000	0.309	159.4	2.398	48.3	0.222	62.7	0.312	-96.9
2200	0.315	153.4	2.204	43.8	0.244	60.7	0.314	-102.6
2400	0.320	147.8	2.044	39.5	0.267	58.7	0.316	-108.0
2600	0.326	142.7	1.911	35.4	0.290	56.6	0.321	-113.1
2800	0.334	137.8	1.799	31.3	0.314	54.3	0.327	-118.8
3000	0.338	133.2	1.700	27.7	0.337	52.2	0.333	-123.7

V_{CE}=3V, I_C=30mA

Freq(MHz)	S ₁₁	∠S ₁₁	S ₂₁	∠S ₂₁	S ₁₂	∠S ₁₂	S ₂₂	∠S ₂₂
100	0.422	-60.6	29.590	135.2	0.016	71.4	0.722	-33.7
200	0.307	-104.4	21.814	112.1	0.025	72.9	0.519	-44.2
300	0.268	-126.8	15.788	100.5	0.037	76.0	0.425	-48.4
400	0.256	-140.7	12.124	93.3	0.047	77.3	0.373	-51.5
500	0.254	-150.8	9.776	88.0	0.058	78.3	0.340	-54.4
600	0.255	-158.5	8.161	83.9	0.070	78.3	0.317	-57.4
700	0.258	-164.9	6.998	80.2	0.081	77.8	0.300	-60.3
800	0.259	-170.4	6.125	77.0	0.093	77.5	0.288	-63.2
900	0.262	-175.2	5.448	74.1	0.105	76.6	0.278	-66.1
1000	0.265	-179.3	4.911	71.3	0.117	75.3	0.272	-68.8
1200	0.270	173.0	4.110	66.2	0.141	73.4	0.263	-74.5
1400	0.275	166.2	3.546	61.3	0.165	71.1	0.259	-80.3
1600	0.281	160.2	3.126	56.7	0.189	68.6	0.259	-86.1
1800	0.287	154.6	2.804	52.3	0.212	66.2	0.260	-91.9
2000	0.292	149.3	2.549	48.0	0.236	63.6	0.263	-97.7
2200	0.299	144.3	2.343	43.7	0.259	61.0	0.266	-103.5
2400	0.305	139.4	2.170	39.7	0.282	58.5	0.269	-109.0
2600	0.310	135.1	2.028	35.9	0.305	56.0	0.275	-114.2
2800	0.317	130.7	1.908	32.0	0.329	53.3	0.280	-119.9
3000	0.320	126.7	1.803	28.5	0.352	50.9	0.287	-124.7

CPH6021

S Parameters (Common emitter)

V_{CE}=3V, I_C=50mA

Freq(MHz)	S ₁₁	∠S ₁₁	S ₂₁	∠S ₂₁	S ₁₂	∠S ₁₂	S ₂₂	∠S ₂₂
100	0.317	-109.4	31.770	125.5	0.013	75.2	0.630	-35.4
200	0.309	-140.2	20.342	105.6	0.023	76.4	0.452	-42.0
300	0.303	-153.5	14.403	96.2	0.034	78.9	0.381	-44.4
400	0.305	-161.9	10.996	89.9	0.045	79.8	0.343	-46.8
500	0.310	-168.1	8.862	85.1	0.057	80.6	0.319	-49.5
600	0.315	-172.9	7.391	81.2	0.068	80.1	0.303	-52.5
700	0.321	-177.3	6.332	77.7	0.080	80.0	0.291	-55.6
800	0.324	178.9	5.544	74.6	0.092	79.1	0.282	-58.6
900	0.329	175.4	4.934	71.7	0.104	78.4	0.275	-61.6
1000	0.332	172.3	4.448	69.0	0.116	77.4	0.271	-64.6
1200	0.338	166.2	3.725	63.8	0.140	75.1	0.267	-70.7
1400	0.344	160.6	3.216	58.9	0.164	72.7	0.265	-77.0
1600	0.351	155.5	2.838	54.1	0.188	70.3	0.267	-83.3
1800	0.356	150.7	2.545	49.6	0.212	67.8	0.270	-89.5
2000	0.362	146.0	2.316	45.2	0.237	65.2	0.275	-95.7
2200	0.369	141.3	2.128	40.9	0.260	62.5	0.279	-101.9
2400	0.374	136.9	1.973	36.8	0.284	60.0	0.284	-107.8
2600	0.379	132.8	1.843	32.9	0.308	57.4	0.290	-113.3
2800	0.387	128.7	1.735	29.0	0.332	54.6	0.297	-119.4
3000	0.389	124.8	1.640	25.5	0.357	52.1	0.304	-124.5

V_{CE}=3V, I_C=80mA

Freq(MHz)	S ₁₁	∠S ₁₁	S ₂₁	∠S ₂₁	S ₁₂	∠S ₁₂	S ₂₂	∠S ₂₂
100	0.476	-152.5	23.097	116.2	0.016	68.9	0.452	-34.8
200	0.527	-167.4	12.902	98.8	0.025	72.7	0.341	-36.3
300	0.540	-174.6	8.790	90.8	0.034	76.2	0.305	-37.7
400	0.547	-179.4	6.612	85.1	0.045	78.8	0.288	-40.3
500	0.553	176.8	5.303	80.5	0.056	79.7	0.277	-43.6
600	0.557	173.5	4.423	76.6	0.068	79.6	0.270	-47.4
700	0.561	170.5	3.794	72.9	0.079	79.6	0.266	-51.2
800	0.564	167.7	3.328	69.7	0.092	79.3	0.264	-55.1
900	0.566	165.0	2.969	66.5	0.104	78.6	0.262	-59.0
1000	0.569	162.4	2.683	63.4	0.116	77.8	0.261	-62.7
1200	0.573	157.4	2.259	57.7	0.141	76.0	0.264	-70.5
1400	0.577	152.6	1.960	52.2	0.166	73.8	0.268	-78.1
1600	0.581	148.0	1.739	47.0	0.191	71.5	0.274	-85.7
1800	0.585	143.4	1.567	42.1	0.218	69.1	0.281	-93.1
2000	0.588	138.9	1.432	37.5	0.244	66.5	0.289	-100.4
2200	0.591	134.4	1.321	33.1	0.270	63.7	0.296	-107.6
2400	0.594	130.1	1.229	29.1	0.297	61.1	0.304	-114.4
2600	0.596	125.9	1.152	25.3	0.323	58.2	0.311	-120.7
2800	0.600	121.6	1.087	21.7	0.350	55.2	0.319	-127.6
3000	0.600	117.6	1.032	18.6	0.377	52.5	0.328	-133.5

CPH6021

S Parameters (Common emitter)

V_{CE}=5V, I_C=10mA

Freq(MHz)	S11	∠S11	S21	∠S21	S12	∠S12	S22	∠S22
100	0.766	-25.4	14.421	149.8	0.020	72.1	0.889	-22.0
200	0.640	-53.7	13.939	132.3	0.031	67.6	0.734	-35.1
300	0.512	-78.9	12.421	117.0	0.041	66.8	0.620	-42.4
400	0.418	-98.6	10.572	105.3	0.049	67.1	0.541	-47.2
500	0.366	-113.3	8.897	97.5	0.058	68.5	0.488	-50.9
600	0.335	-124.8	7.581	91.4	0.067	69.8	0.450	-54.1
700	0.318	-134.3	6.565	86.6	0.076	70.4	0.423	-57.0
800	0.302	-142.8	5.808	82.3	0.086	70.7	0.401	-59.6
900	0.294	-150.2	5.196	78.6	0.096	70.9	0.385	-62.1
1000	0.289	-156.4	4.700	75.2	0.106	70.9	0.373	-64.7
1200	0.284	-167.3	3.953	69.1	0.127	70.3	0.356	-69.6
1400	0.282	-176.6	3.421	63.5	0.148	69.3	0.347	-74.8
1600	0.285	175.3	3.022	58.3	0.169	68.0	0.342	-80.2
1800	0.288	168.1	2.715	53.4	0.191	66.5	0.340	-85.5
2000	0.292	161.5	2.470	48.7	0.213	64.8	0.341	-90.9
2200	0.298	155.4	2.270	44.2	0.236	62.8	0.343	-96.6
2400	0.304	149.6	2.104	39.9	0.258	60.8	0.345	-102.0
2600	0.310	144.4	1.966	35.8	0.281	58.8	0.350	-107.1
2800	0.318	139.3	1.849	31.7	0.305	56.5	0.355	-112.9
3000	0.322	134.7	1.747	28.0	0.329	54.5	0.361	-117.8

V_{CE}=5V, I_C=30mA

Freq(MHz)	S11	∠S11	S21	∠S21	S12	∠S12	S22	∠S22
100	0.447	-51.2	31.013	137.1	0.015	72.3	0.749	-30.3
200	0.303	-94.5	22.794	113.5	0.024	74.5	0.556	-39.8
300	0.254	-118.0	16.483	101.5	0.033	76.9	0.464	-43.7
400	0.237	-133.0	12.654	94.1	0.044	78.3	0.412	-46.5
500	0.232	-144.2	10.199	88.7	0.055	79.6	0.378	-49.1
600	0.231	-152.7	8.520	84.4	0.066	79.4	0.356	-51.8
700	0.233	-159.7	7.304	80.7	0.077	79.3	0.338	-54.5
800	0.234	-165.7	6.390	77.5	0.088	78.6	0.325	-57.1
900	0.236	-171.0	5.681	74.6	0.100	77.8	0.315	-59.9
1000	0.239	-175.6	5.120	71.8	0.111	77.1	0.308	-62.5
1200	0.244	176.1	4.285	66.7	0.134	74.8	0.298	-67.8
1400	0.249	168.9	3.693	61.9	0.157	72.7	0.293	-73.4
1600	0.255	162.5	3.255	57.2	0.180	70.2	0.292	-79.0
1800	0.260	156.7	2.919	52.8	0.203	67.9	0.293	-84.6
2000	0.266	151.2	2.651	48.5	0.226	65.5	0.295	-90.3
2200	0.274	146.0	2.435	44.3	0.249	62.9	0.297	-96.1
2400	0.279	141.0	2.254	40.3	0.272	60.4	0.300	-101.6
2600	0.285	136.4	2.104	36.4	0.295	58.0	0.305	-106.8
2800	0.293	132.0	1.979	32.6	0.318	55.4	0.310	-112.6
3000	0.297	127.9	1.869	29.1	0.341	53.1	0.316	-117.4

CPH6021

S Parameters (Common emitter)

V_{CE}=5V, I_C=50mA

Freq(MHz)	S11	∠S11	S21	∠S21	S12	∠S12	S22	∠S22
100	0.286	-86.2	35.792	128.9	0.013	76.8	0.686	-31.3
200	0.249	-124.8	22.813	107.7	0.022	78.3	0.508	-37.7
300	0.242	-142.0	16.061	97.7	0.032	80.1	0.435	-40.2
400	0.242	-152.3	12.234	91.2	0.042	81.7	0.394	-42.4
500	0.247	-160.1	9.830	86.3	0.053	82.4	0.368	-45.0
600	0.252	-166.1	8.194	82.3	0.064	82.1	0.350	-47.8
700	0.258	-171.3	7.020	78.9	0.075	81.6	0.336	-50.6
800	0.262	-175.7	6.139	75.8	0.087	80.9	0.326	-53.4
900	0.266	-179.8	5.460	72.9	0.098	80.1	0.318	-56.1
1000	0.270	-176.6	4.918	70.2	0.110	78.9	0.313	-58.9
1200	0.276	-169.9	4.112	65.1	0.133	76.8	0.305	-64.5
1400	0.283	-163.8	3.545	60.3	0.156	74.3	0.303	-70.4
1600	0.290	-158.3	3.124	55.7	0.179	71.9	0.302	-76.3
1800	0.296	-153.1	2.801	51.2	0.203	69.5	0.304	-82.2
2000	0.303	-148.2	2.545	46.9	0.226	67.0	0.307	-88.1
2200	0.310	-143.4	2.336	42.7	0.249	64.4	0.310	-94.2
2400	0.316	-138.8	2.163	38.6	0.273	61.9	0.314	-99.9
2600	0.322	-134.6	2.019	34.8	0.296	59.4	0.319	-105.2
2800	0.330	-130.3	1.898	30.9	0.320	56.6	0.324	-111.2
3000	0.334	-126.4	1.792	27.4	0.344	54.3	0.331	-116.4

V_{CE}=5V, I_C=80mA

Freq(MHz)	S11	∠S11	S21	∠S21	S12	∠S12	S22	∠S22
100	0.345	-137.6	29.631	121.2	0.013	65.7	0.593	-27.9
200	0.398	-159.0	16.989	102.4	0.020	76.7	0.468	-29.9
300	0.414	-168.4	11.622	93.6	0.029	79.1	0.426	-31.5
400	0.425	-174.1	8.756	87.6	0.039	82.5	0.403	-34.1
500	0.433	-178.6	7.015	83.0	0.049	83.3	0.388	-36.9
600	0.438	-177.7	5.843	79.0	0.059	83.9	0.378	-40.2
700	0.443	-174.4	5.008	75.5	0.070	83.5	0.370	-43.6
800	0.448	-171.3	4.383	72.3	0.081	83.3	0.364	-46.8
900	0.452	-168.5	3.903	69.3	0.092	82.6	0.360	-50.3
1000	0.455	-165.7	3.519	66.4	0.104	81.8	0.357	-53.6
1200	0.460	-160.5	2.952	60.9	0.127	80.1	0.354	-60.4
1400	0.466	-155.5	2.552	55.7	0.151	78.1	0.355	-67.3
1600	0.472	-150.8	2.254	50.7	0.175	75.9	0.357	-74.2
1800	0.477	-146.2	2.025	45.9	0.200	73.5	0.361	-81.1
2000	0.482	-141.7	1.845	41.3	0.226	71.0	0.366	-87.9
2200	0.488	-137.2	1.695	36.9	0.251	68.4	0.370	-94.6
2400	0.493	-132.9	1.572	32.8	0.278	65.7	0.375	-101.3
2600	0.498	-128.8	1.469	28.9	0.304	63.0	0.380	-107.5
2800	0.504	-124.6	1.382	25.0	0.331	60.1	0.386	-114.1
3000	0.506	-120.6	1.307	21.6	0.359	57.4	0.392	-120.1

CPH6021

S Parameters (Common emitter)

V_{CE}=8V, I_C=10mA

Freq(MHz)	S11	∠S11	S21	∠S21	S12	∠S12	S22	∠S22
100	0.779	-24.4	14.321	150.5	0.018	70.1	0.899	-20.2
200	0.654	-51.5	13.927	133.2	0.029	68.6	0.755	-32.2
300	0.527	-75.6	12.487	118.0	0.038	67.5	0.647	-39.1
400	0.427	-94.7	10.692	106.3	0.047	68.6	0.571	-43.6
500	0.371	-109.3	9.024	98.3	0.055	69.6	0.518	-47.3
600	0.337	-120.7	7.706	92.1	0.063	70.6	0.482	-50.3
700	0.316	-130.2	6.683	87.2	0.072	71.5	0.454	-52.9
800	0.298	-139.0	5.917	82.8	0.082	72.0	0.433	-55.5
900	0.288	-146.5	5.295	79.0	0.091	72.2	0.416	-58.0
1000	0.282	-152.8	4.792	75.6	0.101	72.4	0.404	-60.4
1200	0.275	-164.1	4.032	69.5	0.121	72.0	0.387	-65.2
1400	0.273	-173.8	3.486	63.8	0.141	71.0	0.378	-70.3
1600	0.274	177.9	3.080	58.6	0.162	69.9	0.373	-75.5
1800	0.277	170.5	2.765	53.7	0.183	68.4	0.371	-80.8
2000	0.282	163.6	2.518	49.0	0.205	66.8	0.372	-86.2
2200	0.288	157.4	2.312	44.4	0.227	64.9	0.373	-91.8
2400	0.293	151.4	2.142	40.1	0.250	63.0	0.375	-97.2
2600	0.299	146.0	2.001	36.0	0.273	61.1	0.380	-102.4
2800	0.308	140.8	1.881	31.8	0.297	58.8	0.385	-108.1
3000	0.313	136.1	1.775	28.1	0.321	56.8	0.391	-113.1

V_{CE}=8V, I_C=30mA

Freq(MHz)	S11	∠S11	S21	∠S21	S12	∠S12	S22	∠S22
100	0.474	-47.3	31.092	138.3	0.014	73.7	0.770	-27.4
200	0.315	-88.1	23.124	114.6	0.023	74.9	0.588	-36.2
300	0.256	-111.3	16.805	102.3	0.032	77.7	0.499	-39.7
400	0.232	-126.8	12.923	94.7	0.041	79.9	0.449	-42.3
500	0.224	-138.4	10.426	89.2	0.052	80.5	0.416	-44.8
600	0.221	-147.5	8.709	84.8	0.062	80.5	0.393	-47.4
700	0.221	-155.2	7.470	81.1	0.072	80.4	0.376	-50.0
800	0.222	-161.5	6.535	77.9	0.083	79.9	0.362	-52.5
900	0.223	-167.2	5.812	74.9	0.094	79.0	0.351	-55.1
1000	0.225	-172.0	5.238	72.1	0.106	78.3	0.344	-57.6
1200	0.229	179.1	4.379	67.0	0.128	76.4	0.334	-62.8
1400	0.234	171.6	3.774	62.1	0.150	74.2	0.329	-68.2
1600	0.240	164.8	3.324	57.4	0.173	72.0	0.327	-73.7
1800	0.246	158.8	2.980	53.0	0.195	69.7	0.327	-79.2
2000	0.252	153.1	2.706	48.7	0.218	67.4	0.329	-84.8
2200	0.259	147.7	2.484	44.4	0.240	64.9	0.330	-90.5
2400	0.266	142.5	2.299	40.4	0.263	62.5	0.333	-96.0
2600	0.272	137.9	2.145	36.6	0.285	60.2	0.338	-101.2
2800	0.280	133.4	2.017	32.7	0.309	57.5	0.343	-107.0
3000	0.284	129.2	1.903	29.1	0.332	55.3	0.349	-112.0

CPH6021

S Parameters (Common emitter)

V_{CE}=8V, I_C=50mA

Freq(MHz)	S ₁₁	∠S ₁₁	S ₂₁	∠S ₂₁	S ₁₂	∠S ₁₂	S ₂₂	∠S ₂₂
100	0.306	-72.7	36.956	130.9	0.011	71.4	0.720	-28.3
200	0.240	-113.2	23.684	109.1	0.020	79.6	0.548	-34.3
300	0.225	-133.1	16.651	98.7	0.030	81.1	0.476	-36.5
400	0.223	-145.1	12.680	92.0	0.039	83.0	0.437	-38.8
500	0.226	-154.0	10.188	86.9	0.050	83.4	0.410	-41.3
600	0.230	-160.9	8.491	82.9	0.060	83.2	0.392	-44.0
700	0.235	-166.7	7.273	79.3	0.071	82.8	0.377	-46.7
800	0.239	-171.6	6.356	76.2	0.082	82.1	0.367	-49.3
900	0.243	-176.1	5.651	73.4	0.093	81.0	0.357	-52.1
1000	0.246	-180.0	5.089	70.6	0.104	80.5	0.352	-54.7
1200	0.253	-172.7	4.254	65.6	0.126	78.2	0.344	-60.2
1400	0.259	-166.2	3.665	60.7	0.149	76.0	0.340	-65.8
1600	0.267	-160.5	3.229	56.1	0.171	73.6	0.339	-71.6
1800	0.273	-155.1	2.892	51.7	0.194	71.3	0.340	-77.2
2000	0.280	-149.9	2.627	47.4	0.217	68.8	0.342	-83.0
2200	0.288	-145.0	2.411	43.1	0.240	66.3	0.345	-89.0
2400	0.295	-140.2	2.230	39.1	0.264	63.9	0.348	-94.6
2600	0.301	-135.8	2.080	35.2	0.286	61.5	0.353	-100.0
2800	0.310	-131.6	1.954	31.3	0.310	58.8	0.358	-106.0
3000	0.314	-127.6	1.844	27.8	0.334	56.5	0.364	-111.1

V_{CE}=8V, I_C=80mA

Freq(MHz)	S ₁₁	∠S ₁₁	S ₂₁	∠S ₂₁	S ₁₂	∠S ₁₂	S ₂₂	∠S ₂₂
100	0.308	-126.7	31.174	123.7	0.011	65.2	0.658	-24.0
200	0.360	-153.8	18.003	104.2	0.019	78.8	0.537	-26.2
300	0.378	-164.8	12.329	95.1	0.027	81.1	0.495	-28.2
400	0.388	-171.5	9.301	89.0	0.035	83.9	0.472	-30.9
500	0.395	-176.6	7.456	84.3	0.045	85.8	0.456	-33.9
600	0.401	-179.3	6.212	80.4	0.054	86.0	0.445	-37.1
700	0.407	-175.7	5.328	76.9	0.065	86.1	0.436	-40.4
800	0.411	-172.4	4.665	73.8	0.075	85.9	0.429	-43.7
900	0.414	-169.4	4.154	70.8	0.086	85.4	0.423	-47.0
1000	0.417	-166.4	3.748	68.0	0.097	84.7	0.419	-50.3
1200	0.423	-160.9	3.144	62.7	0.120	83.0	0.415	-56.9
1400	0.428	-155.7	2.718	57.6	0.143	81.1	0.413	-63.6
1600	0.434	-150.9	2.403	52.7	0.167	78.9	0.413	-70.3
1800	0.438	-146.2	2.158	48.1	0.192	76.5	0.414	-77.0
2000	0.443	-141.7	1.966	43.6	0.217	74.0	0.417	-83.6
2200	0.449	-137.2	1.808	39.2	0.243	71.3	0.419	-90.3
2400	0.454	-132.8	1.676	35.1	0.269	68.7	0.422	-96.7
2600	0.459	-128.7	1.567	31.2	0.296	65.8	0.426	-102.9
2800	0.465	-124.5	1.474	27.3	0.323	62.9	0.430	-109.3
3000	0.467	-120.6	1.394	23.9	0.350	60.1	0.435	-115.2

Embossed Taping Specification

CPH6021-TL-H

1. Packing Format

Package Name	Carrier Tape Type	Maximum Number of devices contained (pcs)			Packing format	
		Reel	Inner box	Outer box	Inner BOX (C-1)	Outer BOX (A-7)
CPH6	CPH6	3,000	15,000	90,000	5 reels contained Dimensions:mm (external) 183×72×185	6 inner boxes contained Dimensions:mm (external) 440×195×210

Reel label, Inner box label
(unit:mm)

Outer box label

It is a label at the time of factory shipments.
The form of a label may change in physical distribution process.

Packing method

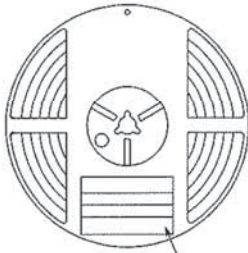

Reel label

Type No.
LOT No.
Quantity
Origin

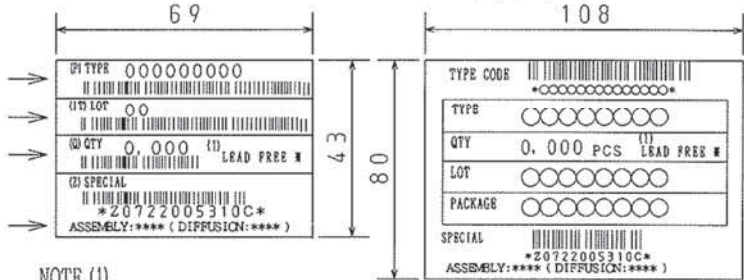

NOTE (1)

The LEAD FREE * description shows that the surface treatment of the terminal is lead free.

Label	JEITA Phase
LEAD FREE 3	JEITA Phase 3A
LEAD FREE 4	JEITA Phase 3

2. Taping configuration

2-1. Carrier tape size (unit:mm)

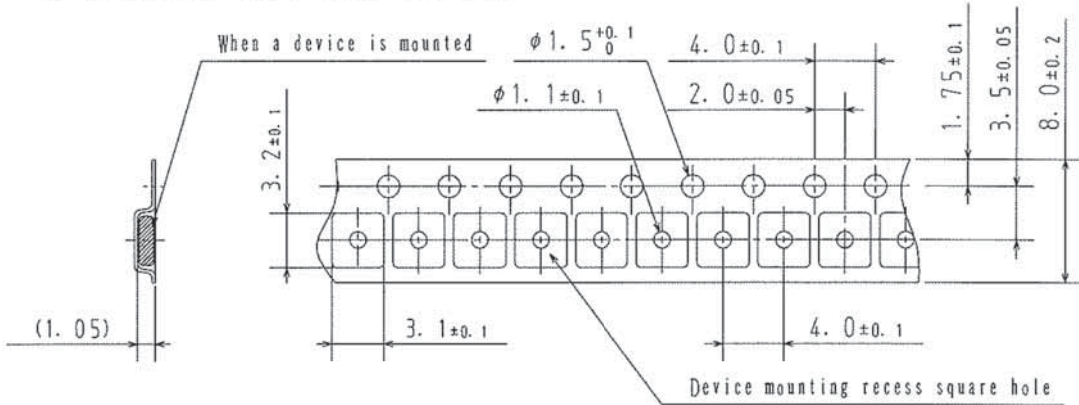

2-2. Device placement direction

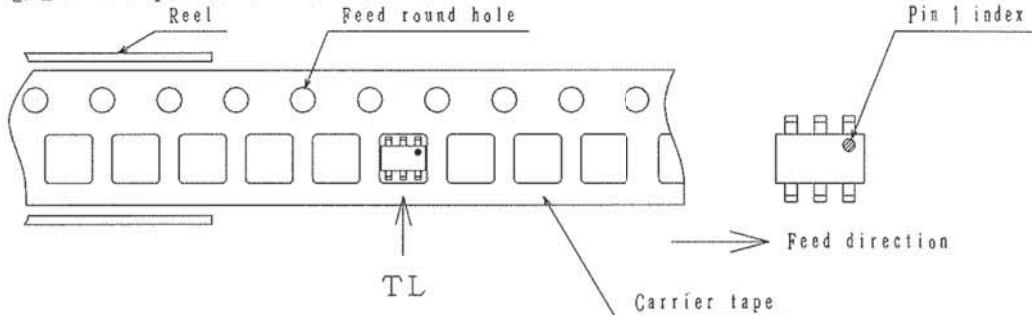

Those with pin 1 index on the feed hole side.....TL

CPH6021

Outline Drawing CPH6021-TL-H

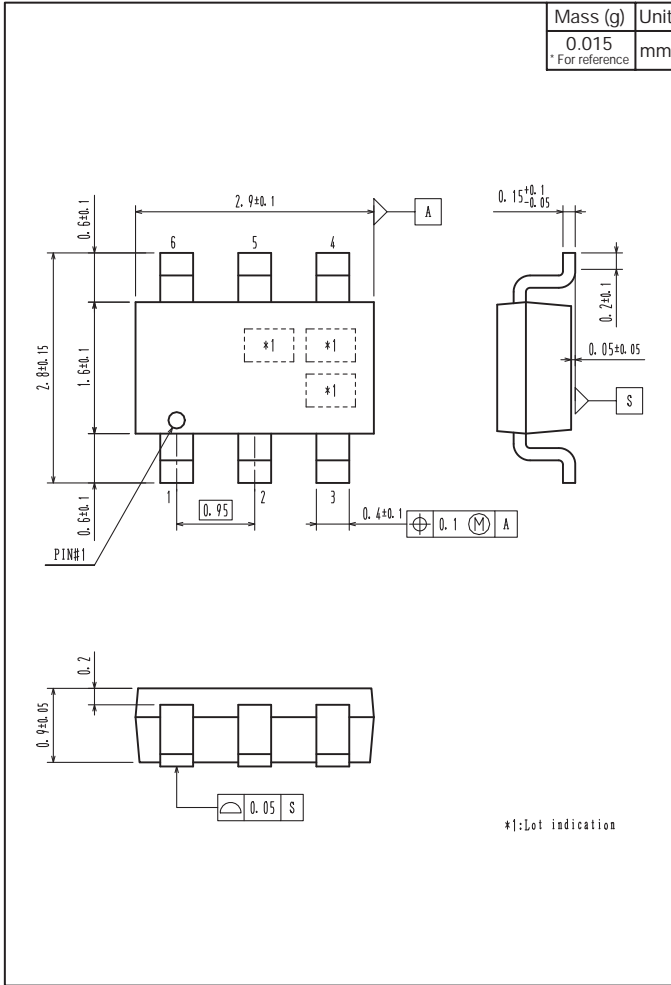

Land Pattern Example

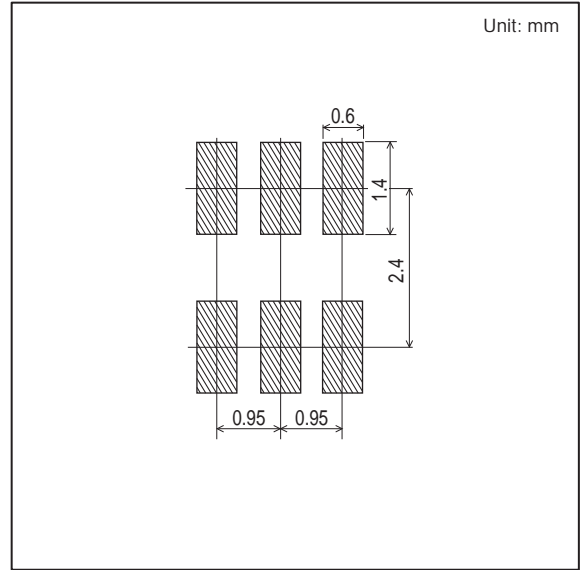

- Any and all SANYO Semiconductor Co.,Ltd. products described or contained herein are, with regard to "standard application", intended for the use as general electronics equipment. The products mentioned herein shall not be intended for use for any "special application" (medical equipment whose purpose is to sustain life, aerospace instrument, nuclear control device, burning appliances, transportation machine, traffic signal system, safety equipment etc.) that shall require extremely high level of reliability and can directly threaten human lives in case of failure or malfunction of the product or may cause harm to human bodies, nor shall they grant any guarantee thereof. If you should intend to use our products for new introduction or other application different from current conditions on the usage of automotive device, communication device, office equipment, industrial equipment etc. , please consult with us about usage condition (temperature, operation time etc.) prior to the intended use. If there is no consultation or inquiry before the intended use, our customer shall be solely responsible for the use.
- Specifications of any and all SANYO Semiconductor Co.,Ltd. products described or contained herein stipulate the performance, characteristics, and functions of the described products in the independent state, and are not guarantees of the performance, characteristics, and functions of the described products as mounted in the customer's products or equipment. To verify symptoms and states that cannot be evaluated in an independent device, the customer should always evaluate and test devices mounted in the customer's products or equipment.
- SANYO Semiconductor Co.,Ltd. assumes no responsibility for equipment failures that result from using products at values that exceed, even momentarily, rated values (such as maximum ratings, operating condition ranges, or other parameters) listed in products specifications of any and all SANYO Semiconductor Co.,Ltd. products described or contained herein.
- Regarding monolithic semiconductors, if you should intend to use this IC continuously under high temperature, high current, high voltage, or drastic temperature change, even if it is used within the range of absolute maximum ratings or operating conditions, there is a possibility of decrease reliability. Please contact us for a confirmation.
- SANYO Semiconductor Co.,Ltd. strives to supply high-quality high-reliability products, however, any and all semiconductor products fail or malfunction with some probability. It is possible that these probabilistic failures or malfunction could give rise to accidents or events that could endanger human lives, trouble that could give rise to smoke or fire, or accidents that could cause damage to other property. When designing equipment, adopt safety measures so that these kinds of accidents or events cannot occur. Such measures include but are not limited to protective circuits and error prevention circuits for safe design, redundant design, and structural design.
- In the event that any or all SANYO Semiconductor Co.,Ltd. products described or contained herein are controlled under any of applicable local export control laws and regulations, such products may require the export license from the authorities concerned in accordance with the above law.
- No part of this publication may be reproduced or transmitted in any form or by any means, electronic or mechanical, including photocopying and recording, or any information storage or retrieval system, or otherwise, without the prior written consent of SANYO Semiconductor Co.,Ltd.
- Any and all information described or contained herein are subject to change without notice due to product/technology improvement, etc. When designing equipment, refer to the "Delivery Specification" for the SANYO Semiconductor Co.,Ltd. product that you intend to use.
- Upon using the technical information or products described herein, neither warranty nor license shall be granted with regard to intellectual property rights or any other rights of SANYO Semiconductor Co.,Ltd. or any third party. SANYO Semiconductor Co.,Ltd. shall not be liable for any claim or suits with regard to a third party's intellectual property rights which has resulted from the use of the technical information and products mentioned above.

This catalog provides information as of June, 2012. Specifications and information herein are subject to change without notice.