



Ideal for solar inverter compact size, 1a 22A/33A power relays

LF-G RELAYS (ALFG)



RoHS compliant

FEATURES

• High capacity

High capacity control possible at 22A/33A (High capacity type) 250V AC rating in compact size (L: 15.7 × W: 30.1 × H: 23.3 mm L: .618 × W: 1.185 × H: .917 inch)

• Contact gap: 1.5 mm .059 inch and 1.8 mm* .071 inch**

Compliant with European photovoltaic standard (IEC62109* and VDE0126**).

* Safety standard of PV power inverter
 ** German safety standard of PV power inverter
 *** Due to addition of altitude stipulation (2,000 m 6,561.68 ft or more) to IEC62109.

EN61810-1 certified: 2.5 kV surge breakdown voltage (between contacts)

• High insulation resistance

Creepage distance between contact and coil terminal: Min. 9.5 mm .354 inch
 Clearance distance between contact and coil terminal: Min. 6.5 mm .256 inch
 Surge breakdown voltage: 6 kV

• Coil holding voltage contributes to saving energy of equipment

The coil holding voltage can be reduced up to 35%V of the nominal coil voltage (Ambient temperature: 20°C 68°F).
 Power consumption at the lowest coil holding voltage: 170 mW equivalent

*Coil holding voltage is the coil voltage after 100 ms from the applied nominal coil voltage.

*When the ambient temperature during use is 85°C 185°F, make the coil holding voltage between 45% and 80%V of the nominal coil voltage.

• Conforms to various safety standards

UL/C-UL and VDE approved

TYPICAL APPLICATIONS

- Photovoltaic power generation systems (Power conditioner)
- Uninterruptible Power Supplies (UPS)
- Home appliances
- Office equipment

ORDERING INFORMATION

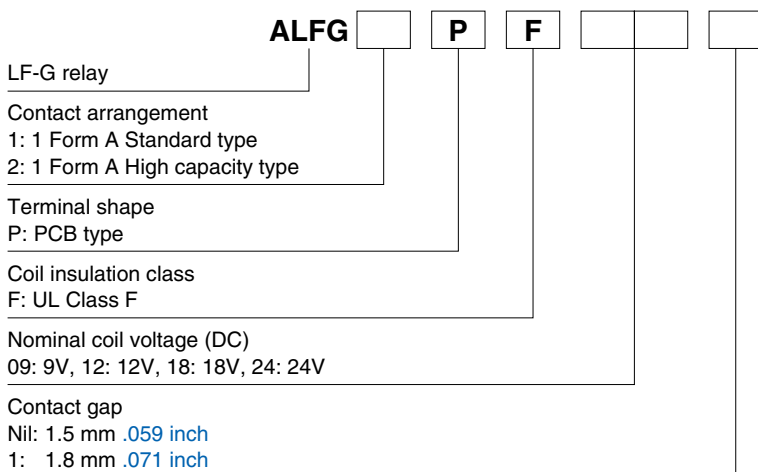

Note: Certified by UL/C-UL and VDE

TYPES

Contact arrangement	Nominal coil voltage	Part No.			
		Contact Gap 1.5 mm .059 inch type		Contact Gap 1.8 mm .071 inch type	
		Standard type	High capacity type	Standard type	High capacity type
1 Form A	9V DC	ALFG1PF09	ALFG2PF09	ALFG1PF091	ALFG2PF091
	12V DC	ALFG1PF12	ALFG2PF12	ALFG1PF121	ALFG2PF121
	18V DC	ALFG1PF18	ALFG2PF18	ALFG1PF181	ALFG2PF181
	24V DC	ALFG1PF24	ALFG2PF24	ALFG1PF241	ALFG2PF241

Standard packing: Carton: 50 pcs.; Case: 200 pcs.

RATING

Coil data

Nominal coil voltage	Pick-up voltage (at 20°C 68°F) (Initial)	Drop-out voltage (at 20°C 68°F) (Initial)	Nominal operating current [±10%] (at 20°C 68°F)	Coil resistance [±10%] (at 20°C 68°F)	Nominal operating power	Max. applied voltage (at 20°C 68°F)
9V DC	70%V or less of nominal voltage	10%V or more of nominal voltage	155mA	58Ω	1,400mW	120%V of nominal voltage
12V DC			117mA	103Ω		
18V DC			78mA	230Ω		
24V DC			59mA	410Ω		

Specifications

Characteristics	Item	Specifications			
		Standard type	High capacity type		
		Contact Gap 1.5 mm .059 inch type Contact Gap 1.8 mm .071 inch type	Contact Gap 1.5 mm .059 inch type	Contact Gap 1.8 mm .071 inch type	
Contact	Arrangement	1 Form A			
	Contact resistance (Initial)	Max. 100 mΩ (By voltage drop 6 V DC 1A)			
	Contact material	AgSnO ₂ type			
Rating	Nominal switching capacity	22A 250V AC	31A 250V AC	33A 250V AC	
	Max. switching power	5,500VA	7,750VA	8,250VA	
	Max. switching voltage	250V AC			
	Max. switching current	22A (AC)	31A (AC)	33A (AC)	
	Nominal operating power	1,400mW			
	Min. switching capacity (Reference value)*1	100mA 5V DC			
Electrical characteristics	Insulation resistance (Initial)	Min. 1,000MΩ (at 500V DC) Measurement at same location as "Breakdown voltage" section.			
	Breakdown voltage (Initial)	Between open contacts	2,500 Vrms for 1 min. (Detection current: 10 mA)		
		Between contact and coil	4,000 Vrms for 1 min. (Detection current: 10 mA)		
	Surge breakdown voltage*2 (Between contact and coil) (Initial)	6,000 V			
	Temperature rise*3 (coil)	Max. 95°C 203°F (By resistive method, nominal coil voltage applied to the coil; contact carrying current: 22A, at 60°C 140°F)	Max. 95°C 203°F (By resistive method, nominal coil voltage applied to the coil; contact carrying current: 31A, at 60°C 140°F)	Max. 95°C 203°F (By resistive method, nominal coil voltage applied to the coil; contact carrying current: 33A, at 60°C 140°F)	
		Max. 70°C 158°F (By resistive method, 80%V of nominal coil voltage applied to the coil; contact carrying current: 22A, at 85°C 185°F)	Max. 70°C 158°F (By resistive method, 80%V of nominal coil voltage applied to the coil; contact carrying current: 31A, at 85°C 185°F)	Max. 70°C 158°F (By resistive method, 80%V of nominal coil voltage applied to the coil; contact carrying current: 33A, at 85°C 185°F)	
	Coil holding voltage*4	35 to 120%V (contact carrying current: 22A, at 20°C 68°F) 45 to 80%V (contact carrying current: 22A, at 85°C 185°F)	35 to 120%V (contact carrying current: 31A, at 20°C 68°F) 45 to 80%V (contact carrying current: 31A, at 85°C 185°F)	35 to 120%V (contact carrying current: 33A, at 20°C 68°F) 45 to 80%V (contact carrying current: 33A, at 85°C 185°F)	
	Operate time (at 20°C 68°F)	Max. 20 ms (at nominal coil voltage excluding contact bounce time.)			
	Release time (at 20°C 68°F)	Max. 10 ms (at nominal coil voltage excluding contact bounce time, without diode)			
	Mechanical characteristics	Shock resistance	Functional	Min. 100 m/s ² (Half-wave pulse of sine wave: 11 ms; detection time: 10μs.)	
Vibration resistance		Functional	Min. 1,000 m/s ² (Half-wave pulse of sine wave: 6 ms.)		
	Destructive	10 to 55 Hz at double amplitude of 1.5 mm (Detection time: 10μs.)			
Expected life	Mechanical	Contact Gap 1.5 mm .059 inch type: Min. 10 ⁶ (at 180 times/min.) Contact Gap 1.8 mm .071 inch type: Min. 5×10 ⁵ (at 180 times/min.)			
	Electrical	Resistive load	22A 250V AC, Min. 3×10 ⁴ (at 20 times/min.)	—	—
Inductive load		Destructive: 22A 250V AC (cosφ = 0.8), Min. 3×10 ⁴ (on:off = 0.1s:10s) Over load: 35A 250V AC (cosφ = 0.8), Min. 50 (on:off = 0.1s:10s)	Destructive: 31A 250V AC (cosφ = 0.8), Min. 3×10 ⁴ (on:off = 0.1s:10s) Over load: 47A 250V AC (cosφ = 0.8), Min. 50 (on:off = 0.1s:10s)	Destructive: 33A 250V AC (cosφ = 0.8), Min. 3×10 ⁴ (on:off = 0.1s:10s) Over load: 50A 250V AC (cosφ = 0.8), Min. 50 (on:off = 0.1s:10s)	
Conditions	Conditions for operation, transport and storage*5	Ambient temperature: -40°C to +60°C -40°F to +140°F (When nominal coil voltage applied) -40°C to +85°C -40°F to +185°F (Coil holding voltage is when 45 to 80%V of nominal coil voltage is applied.) Humidity: 5 to 85% R.H. (Not freezing and condensing at low temperature) Air pressure: 86 to 106 kPa			
Unit weight		Approx. 23 g .81 oz			

Notes: *1. This value can change due to the switching frequency, environmental conditions, and desired reliability level, therefore it is recommended to check this with the actual load.

*2. Wave is standard shock voltage of ±1.2×50μs according to JEC-212-1981

*3. In accordance with UL class-F

*4. Coil holding voltage is the coil voltage after 100 ms from the applied nominal coil voltage.

*5. The upper limit of the ambient temperature is the maximum temperature that can satisfy the coil temperature rise value. Refer to Usage, transport and storage conditions in NOTES.

REFERENCE DATA

Standard type (Contact Gap 1.5 mm .059 inch type) (Contact Gap 1.8 mm .071 inch type)

1. Coil temperature rise

Sample: ALFG1PF09, ALFG1PF091, 6 pcs.

Point measured: coil inside

Ambient temperature: 20°C 68°F, 60°C 140°F

Contact carrying current: 22A

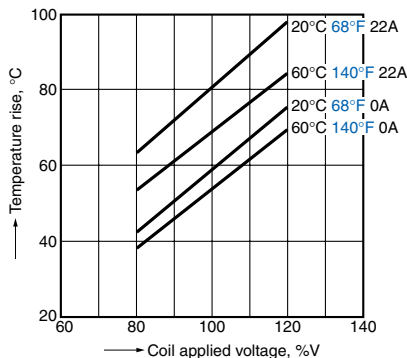

2. Ambient temperature characteristics and coil applied voltage

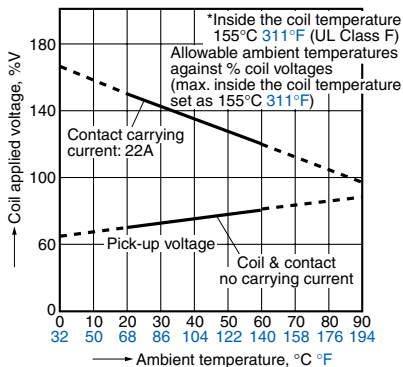

3. Electrical life test

(22A 250V AC Resistive load)

Sample: ALFG1PF09, ALFG1PF091, 6 pcs.

Operation frequency: ON:OFF = 1.5s:1.5s

Ambient temperature: 85°C 185°F

Circuit:

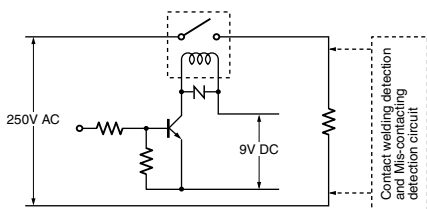

Change of pick-up and drop-out voltage

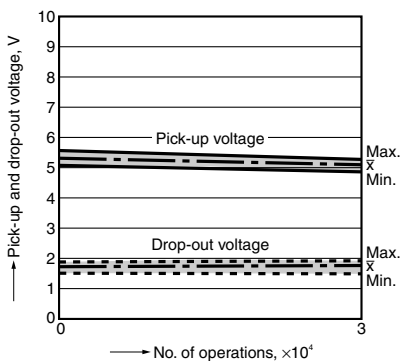

Change of contact resistance

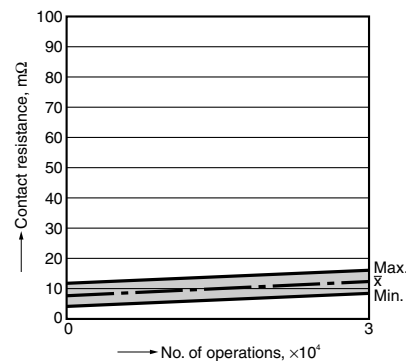

4. Electrical life test

(22A 250V AC cosφ = 0.8 Inductive load)

Sample: ALFG1PF09, ALFG1PF091, 6 pcs.

Operation frequency: ON:OFF = 0.1s:10s

Ambient temperature: 85°C 185°F

Circuit:

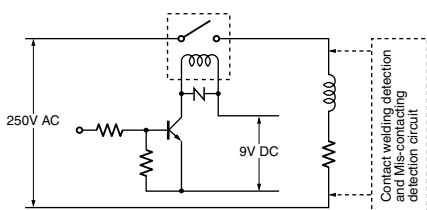

Change of pick-up and drop-out voltage

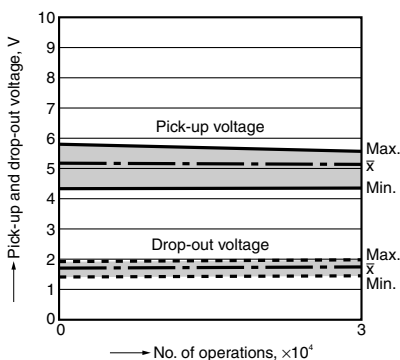

Change of contact resistance

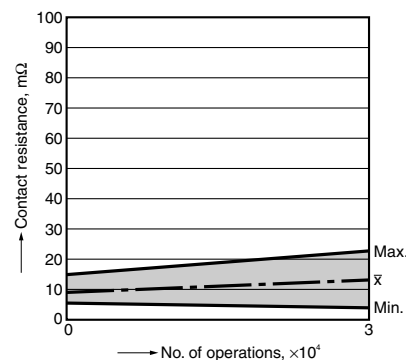

LF-G (ALFG)

High capacity type (Contact Gap 1.5 mm .059 inch type)

1. Coil temperature rise

Sample: ALFG2PF09, 6 pcs.

Point measured: coil inside

Ambient temperature: 20°C 68°F, 60°C 140°F

Contact carrying current: 31A

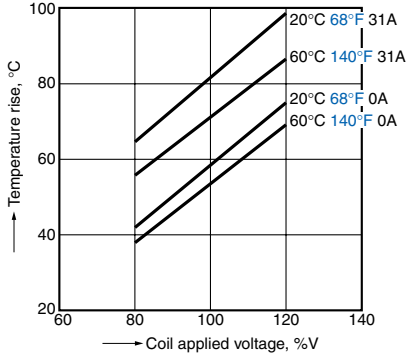

2. Ambient temperature characteristics and coil applied voltage

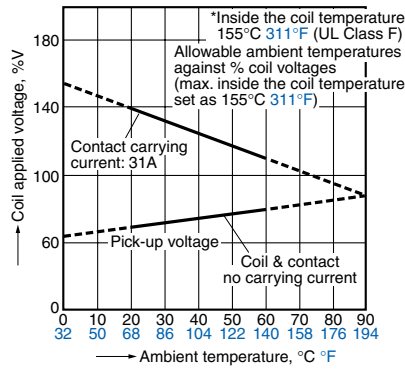

3. Electrical life test

(31A 250V AC $\cos\phi = 0.8$ Inductive load)

Sample: ALFG2PF09, 6 pcs.

Operation frequency: ON:OFF = 0.1s:10s

Ambient temperature: 85°C 185°F

Circuit:

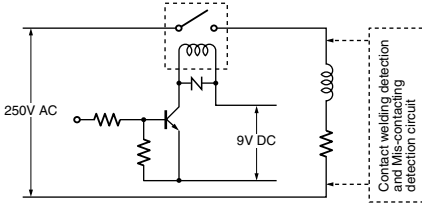

Change of pick-up and drop-out voltage

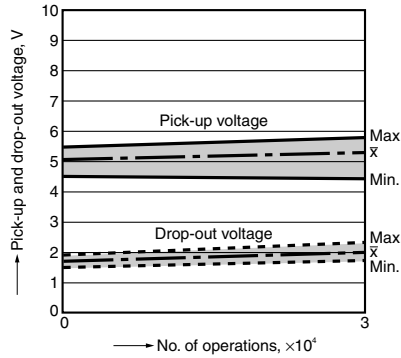

Change of contact resistance

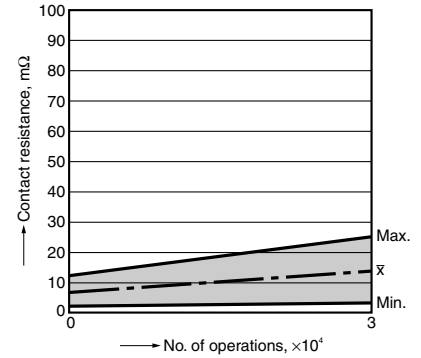

High capacity type (Contact Gap 1.8 mm .071 inch type)

1. Coil temperature rise

Sample: ALFG2PF091, 6 pcs.

Point measured: coil inside

Ambient temperature: 20°C 68°F, 60°C 140°F

Contact carrying current: 33A

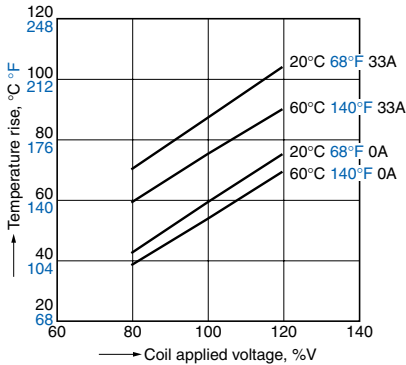

2. Ambient temperature characteristics and coil applied voltage

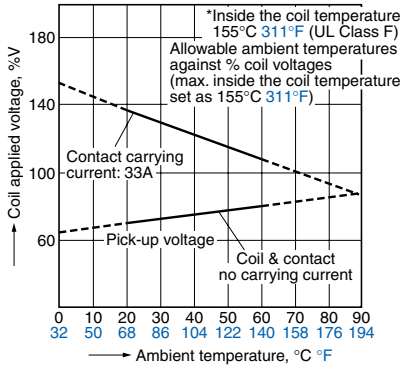

3. Electrical life test

(33A 250V AC $\cos\phi = 0.8$ Inductive load)

Sample: ALFG2PF091, 6 pcs.

Operation frequency: ON:OFF = 0.1s:10s

Ambient temperature: 85°C 185°F

Circuit:

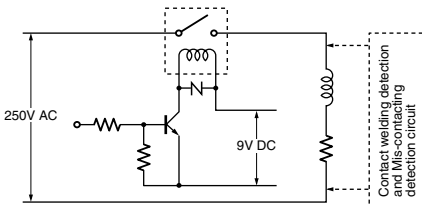

Change of pick-up and drop-out voltage

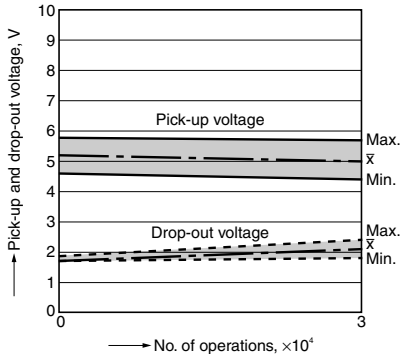

Change of contact resistance

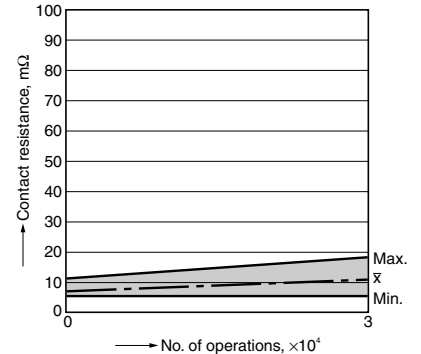

DIMENSIONS (mm inch)

The CAD data of the products with a **CAD Data** mark can be downloaded from: <http://industrial.panasonic.com/ac/e/>

CAD Data



External dimensions

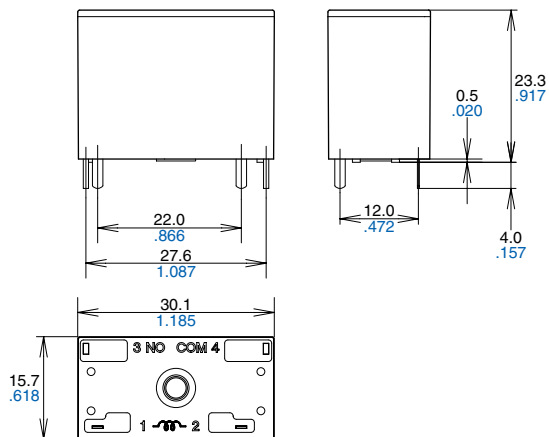

PC board pattern (Bottom view)

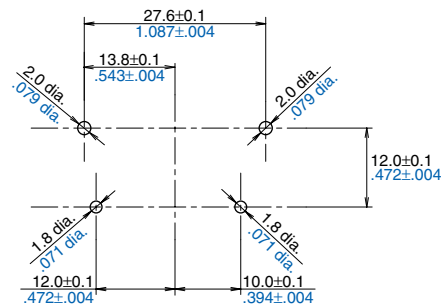

Tolerance: ±0.1 ±.004

Schematic (Bottom view)

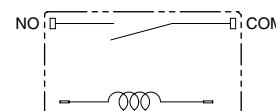

Dimension:

Less than 1mm **.039inch**:
 Min. 1mm **.039inch** less than 3mm **.118 inch**: ±0.2 ±.008
 Min. 3mm **.118 inch**:

General tolerance

±0.1 ±.004
 ±0.2 ±.008
 ±0.3 ±.012

SAFETY STANDARDS

Certification authority	Standard type	High capacity type	
	Contact Gap 1.5 mm .059 inch type Contact Gap 1.8 mm .071 inch type	Contact Gap 1.5 mm .059 inch type	Contact Gap 1.8 mm .071 inch type
UL/C-UL	22A 277V AC General Use (at 85°C 185°F)	31A 277V AC General Use (at 85°C 185°F)	33A 277V AC General Use (at 85°C 185°F)
VDE (VDE0435)	22A 250V AC cosφ = 0.8 (at 85°C 185°F)	31A 250V AC cosφ = 0.8 (at 85°C 185°F)	33A 250V AC cosφ = 0.8 (at 85°C 185°F)

NOTES

Usage, transport and storage conditions

- Temperature:
 - 40 to +60°C **-40 to +140°F** (When nominal coil voltage applied)
 - 40 to +85°C **-40 to +185°F** (When coil holding voltage is 45% to 80% of the nominal coil voltage)
- Humidity: 5 to 85% RH (Avoid freezing and condensation.)
 The humidity range varies with the temperature. Use within the range indicated in the graph below.
- Atmospheric pressure: 86 to 106 kPa
 Temperature and humidity range for usage, transport, and storage

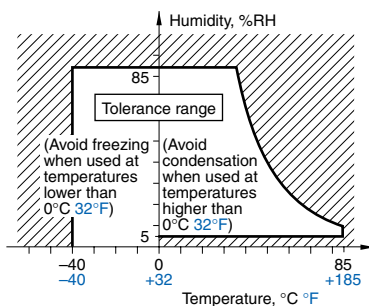
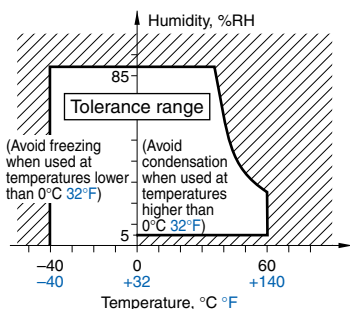

* -40 to +85°C **-40 to +185°F** (When 45% to 80%V of coil holding voltage)

- Condensation
 Condensation forms when there is a sudden change in temperature under high temperature and high humidity conditions. Condensation will cause deterioration of the relay insulation.
- Freezing
 Condensation or other moisture may freeze on the relay when the temperatures is lower than 0°C 32°F. This causes problems such as sticking of movable parts or operational time lags.
- Low temperature, low humidity environments
 The plastic becomes brittle if the relay is exposed to a low temperature, low humidity environment for long periods of time.

Solder and cleaning conditions

- Please obey the following conditions when soldering automatically.
 - Preheating: Within 120°C 248°F (solder surface terminal portion) and within 120 seconds
 - Soldering iron: 260°C±5°C 500°F±41°F (solder temperature) and within 6 seconds (soldering time)
- Since this is not a sealed type relay, do not clean it as is. Also, be careful not to allow flux to overflow above the PC board or enter the inside of the relay.

LF-G (ALFG)

■ Certification

1) This relay is UL/C-UL certified.

UL/C-UL;

Standard type (Contact Gap 1.5 mm

.059 inch & 1.8 mm .071 inch):

22A 277V AC General Use

High capacity type

(Contact Gap 1.5 mm .059 inch):

31A 277V AC General Use

High capacity type

(Contact Gap 1.8 mm .071 inch):

33A 277V AC General Use

2) This relay is certified by VDE

(VDE0435).

VDE;

Standard type (Contact Gap 1.5 mm

.059 inch & 1.8 mm .071 inch):

22A 250V AC $\cos\phi = 0.8$

High capacity type

(Contact Gap 1.5 mm .059 inch):

31A 250V AC $\cos\phi = 0.8$

High capacity type

(Contact Gap 1.8 mm .071 inch):

33A 250V AC $\cos\phi = 0.8$

■ Cautions for use

1) For precautions regarding use and explanations of technical terminology, please refer to our web site.

(<http://industrial.panasonic.com/ac/e/>)

2) To ensure good operation, please keep the voltage on the coil ends to $\pm 5\%$ (at 20°C 68°F) of the rated coil operation voltage. Also, please be aware that the pick-up voltage and drop-out voltage may change depending on the temperature and conditions of use.

3) Keep the ripple rate of the nominal coil voltage below 5%.

4) Please test with actual device when using the coil holding voltage with PWM control.

5) The cycle lifetime is defined under the standard test condition specified in the JIS C5442 standard (temperature 15 to 35°C 59 to 95°F, humidity 25 to 75%). Check this with the real device as it is affected by coil driving circuit, load type, activation frequency, activation phase, ambient conditions and other factors. Also, be especially careful of loads such as those listed below.

(1) When used for AC load-operating and the operating phase is synchronous.

Rocking and fusing can easily occur due to contact shifting.

(2) Highly frequent load-operating

When highly frequent opening and closing of the relay is performed with a load that causes arcs at the contacts, nitrogen and oxygen in the air is fused by the arc energy and HNO_3 is formed. This can corrode metal materials.

Three countermeasures for these are listed here.

- Incorporate an arc-extinguishing circuit.
- Lower the operating frequency
- Lower the ambient humidity

6) This value can change due to the switching frequency, environmental conditions, and desired reliability level, therefore it is recommended to check this with the actual load.

7) Heat, smoke, and even a fire may occur if the relay is used in conditions outside of the allowable ranges for the coil ratings, contact ratings, operating cycle lifetime, and other specifications. Therefore, do not use the relay if these ratings are exceeded.

8) If the relay has been dropped, the appearance and characteristics should always be checked before use.

9) Incorrect wiring may cause unexpected events or the generation of heat or flames.

10) If complying with the Electrical Appliance and Material Safety Law (300V AC), please use with a nominal current no higher than 10A.

11) In order to reduce the occurrence of solder cracking due to thermal stress on the PC board, please use a double-face through hole PC board.

Please contact

Panasonic Corporation

Automation Controls Business Division

■ Head Office: 1048, Kadoma, Kadoma-shi, Osaka 571-8686, Japan

■ Telephone: +81-6-6908-1050 ■ Facsimile: +81-6-6908-5781

industrial.panasonic.com/ac/e/

Panasonic®

© Panasonic Corporation 2013