

Dual Enhancement Mode MOSFET (N- and P-Channel)

Features

- N-Channel
30V/7A,
 $R_{DS(ON)} = 20m\Omega$ (typ.) @ $V_{GS} = 10V$
 $R_{DS(ON)} = 30m\Omega$ (typ.) @ $V_{GS} = 4.5V$
- P-Channel
-30V/-5A,
 $R_{DS(ON)} = 40m\Omega$ (typ.) @ $V_{GS} = -10V$
 $R_{DS(ON)} = 62m\Omega$ (typ.) @ $V_{GS} = -4.5V$
- Super High Dense Cell Design
- Reliable and Rugged
- Lead Free and Green Devices Available (RoHS Compliant)

Applications

- Power Management in Notebook Computer, Portable Equipment and Battery Powered Systems

Pin Description

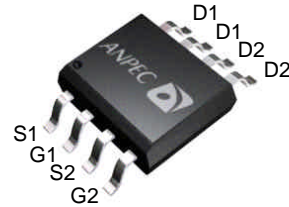

Top View of SOP – 8

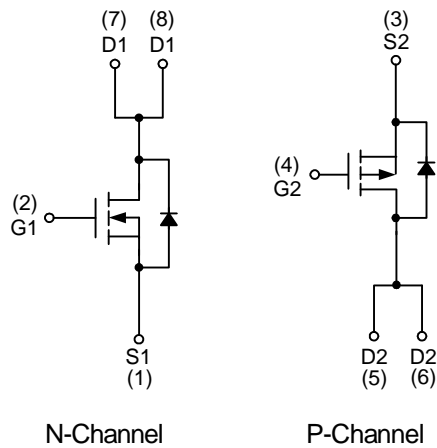

Ordering and Marking Information

<p>APM4550 □□-□□□</p> <ul style="list-style-type: none"> □ Assembly Material □ Handling Code □ Temperature Range □ Package Code 	<p>Package Code K : SOP-8</p> <p>Operating Junction Temperature Range C : -55 to 150 °C</p> <p>Handling Code TR : Tape & Reel</p> <p>Assembly Material G : Halogen and Lead Free Device</p>
<p>APM4550 K : APM4550 XXXXX</p>	<p>XXXXXX - Date Code</p>

Note: ANPEC lead-free products contain molding compounds/die attach materials and 100% matte tin plate termination finish; which are fully compliant with RoHS. ANPEC lead-free products meet or exceed the lead-free requirements of IPC/JEDEC J-STD-020C for MSL classification at lead-free peak reflow temperature. ANPEC defines “Green” to mean lead-free (RoHS compliant) and halogen free (Br or Cl does not exceed 900ppm by weight in homogeneous material and total of Br and Cl does not exceed 1500ppm by weight).

ANPEC reserves the right to make changes to improve reliability or manufacturability without notice, and advise customers to obtain the latest version of relevant information to verify before placing orders.

Absolute Maximum Ratings ($T_A = 25^\circ\text{C}$ unless otherwise noted)

Symbol	Parameter		Rating		Unit
			N Channel	P Channel	
V_{DSS}	Drain-Source Voltage		30	-30	V
V_{GSS}	Gate-Source Voltage		± 20	± 20	
I_D^*	Continuous Drain Current	$V_{GS}=\pm 10V$	7	-5	A
I_{DM}^*	300 μs Pulsed Drain Current		30	-20	
I_S^*	Diode Continuous Forward Current		2.5	-2	A
T_J	Maximum Junction Temperature		150		$^\circ\text{C}$
T_{STG}	Storage Temperature Range		-55 to 150		
P_D^*	Power Dissipation		$T_A=25^\circ\text{C}$		W
			$T_A=100^\circ\text{C}$		
$R_{\theta JA}^*$	Thermal Resistance-Junction to Ambient		62.5		$^\circ\text{C/W}$

Note: *Surface Mounted on 1in² pad area, $t \leq 10\text{sec}$.

Electrical Characteristics ($T_A = 25^\circ\text{C}$ unless otherwise noted)

Symbol	Parameter	Test Conditions	APM4550			Unit	
			Min.	Typ.	Max.		
Static Characteristics							
BV_{DSS}	Drain-Source Breakdown Voltage	$V_{GS}=0V, I_{DS}=250\mu\text{A}$	N-Ch	30	-	-	V
		$V_{GS}=0V, I_{DS}=-250\mu\text{A}$	P-Ch	-30	-	-	
I_{DSS}	Zero Gate Voltage Drain Current	$V_{DS}=24V, V_{GS}=0V$ $T_J=85^\circ\text{C}$	N-Ch	-	-	1	μA
			P-Ch	-	-	-1	
		$V_{DS}=-24V, V_{GS}=0V$ $T_J=85^\circ\text{C}$	N-Ch	-	-	30	
			P-Ch	-	-	-30	
$V_{GS(th)}$	Gate Threshold Voltage	$V_{DS}=V_{GS}, I_{DS}=250\mu\text{A}$	N-Ch	1	1.5	2	V
		$V_{DS}=V_{GS}, I_{DS}=-250\mu\text{A}$	P-Ch	-1	-1.5	-2	
I_{GSS}	Gate Leakage Current	$V_{GS}=\pm 20V, V_{DS}=0V$	N-Ch	-	-	± 100	nA
			P-Ch	-	-	± 100	
$R_{DS(ON)}^a$	Drain-Source On-State Resistance	$V_{GS}=10V, I_{DS}=7A$	N-Ch	-	20	27.5	m Ω
		$V_{GS}=-10V, I_{DS}=-5A$	P-Ch	-	40	50	
		$V_{GS}=4.5V, I_{DS}=5A$	N-Ch	-	30	40	
		$V_{GS}=-4.5V, I_{DS}=-4A$	P-Ch	-	62	80	

Electrical Characteristics (Cont.) ($T_A = 25^\circ\text{C}$ unless otherwise noted)

Symbol	Parameter	Test Conditions	APM4550			Unit	
			Min.	Typ.	Max.		
Diode Characteristics							
V_{SD}^a	Diode Forward Voltage	$I_{SD}=2.5\text{A}, V_{GS}=0\text{V}$	N-Ch	-	0.8	1.3	V
		$I_{SD}=-2\text{A}, V_{GS}=0\text{V}$	P-Ch	-	-0.8	-1.3	
t_{rr}	Reverse Recovery Time	N-Channel $I_{SD}=7\text{A}, dI_{SD}/dt=100\text{A}/\mu\text{s}$	N-Ch	-	8	-	ns
			P-Ch	-	13	-	
Q_{rr}	Reverse Recovery Charge	N-Channel $I_{SD}=-5\text{A}, dI_{SD}/dt=100\text{A}/\mu\text{s}$	N-Ch	-	3	-	nC
			P-Ch	-	5	-	
Dynamic Characteristics^b							
R_G	Gate Resistance	$V_{GS}=0\text{V}, V_{DS}=0\text{V}, F=1\text{MHz}$	N-Ch	-	2	-	Ω
			P-Ch	-	8.3	-	
C_{iss}	Input Capacitance	N-Channel $V_{GS}=0\text{V}, V_{DS}=15\text{V},$ Frequency=1.0MHz	N-Ch	-	620	-	pF
C_{oss}	Output Capacitance		P-Ch	-	590	-	
C_{rss}	Reverse Transfer Capacitance	P-Channel $V_{GS}=0\text{V}, V_{DS}=-15\text{V},$ Frequency=1.0MHz	N-Ch	-	85	-	
			P-Ch	-	95	-	
$t_{d(ON)}$	Turn-on Delay Time	N-Channel $V_{DD}=15\text{V}, R_L=15\Omega,$ $I_{DS}=1\text{A}, V_{GEN}=10\text{V},$ $R_G=6\Omega$	N-Ch	-	6	11	ns
			P-Ch	-	5	9	
T_r	Turn-on Rise Time	P-Channel $V_{DD}=-15\text{V}, R_L=15\Omega,$ $I_{DS}=-1\text{A}, V_{GEN}=-10\text{V},$ $R_G=6\Omega$	N-Ch	-	10	18	
			P-Ch	-	12	23	
$t_{d(OFF)}$	Turn-off Delay Time	N-Channel $V_{DD}=15\text{V}, R_L=15\Omega,$ $I_{DS}=1\text{A}, V_{GEN}=10\text{V},$ $R_G=6\Omega$	N-Ch	-	22	41	
			P-Ch	-	27	50	
T_f	Turn-off Fall Time	P-Channel $V_{DD}=-15\text{V}, R_L=15\Omega,$ $I_{DS}=-1\text{A}, V_{GEN}=-10\text{V},$ $R_G=6\Omega$	N-Ch	-	3	6	
			P-Ch	-	13	24	
Gate Charge Characteristics^b							
Q_g	Total Gate Charge	N-Channel $V_{DS}=15\text{V}, V_{GS}=10\text{V},$ $I_{DS}=7\text{A}$	N-Ch	-	14	19	nC
			P-Ch	-	11	15	
Q_{gs}	Gate-Source Charge	P-Channel $V_{DS}=-15\text{V}, V_{GS}=-10\text{V},$ $I_{DS}=-5\text{A}$	N-Ch	-	1.4	-	
			P-Ch	-	1.3	-	
Q_{gd}	Gate-Drain Charge	N-Channel $V_{DS}=15\text{V}, V_{GS}=10\text{V},$ $I_{DS}=7\text{A}$	N-Ch	-	2.6	-	
			P-Ch	-	2.7	-	

Note a : Pulse test ; pulse width $\leq 300\mu\text{s}$, duty cycle $\leq 2\%$.

Note b : Guaranteed by design, not subject to production testing.

Typical Operating Characteristics

N-Channel

Power Dissipation

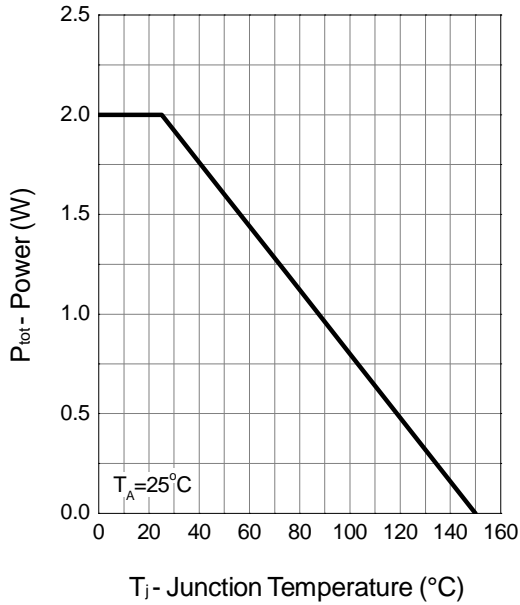

Drain Current

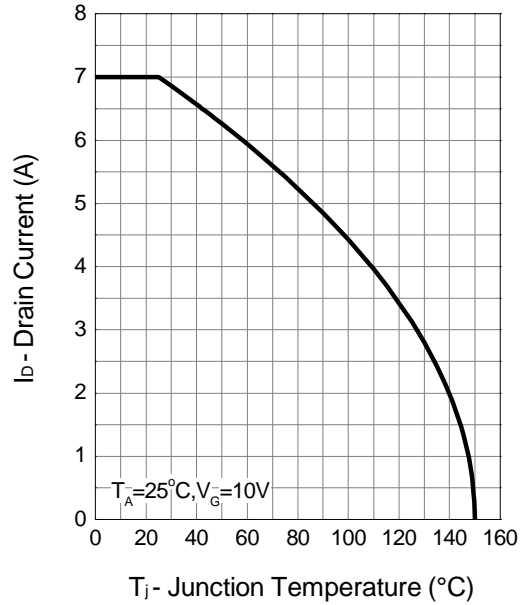

Safe Operation Area

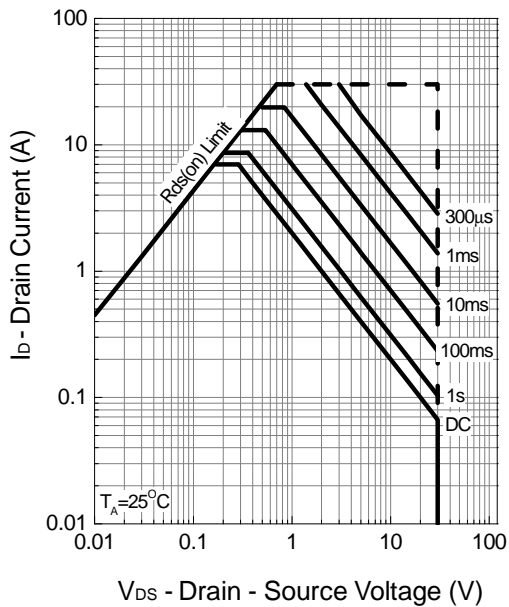

Thermal Transient Impedance

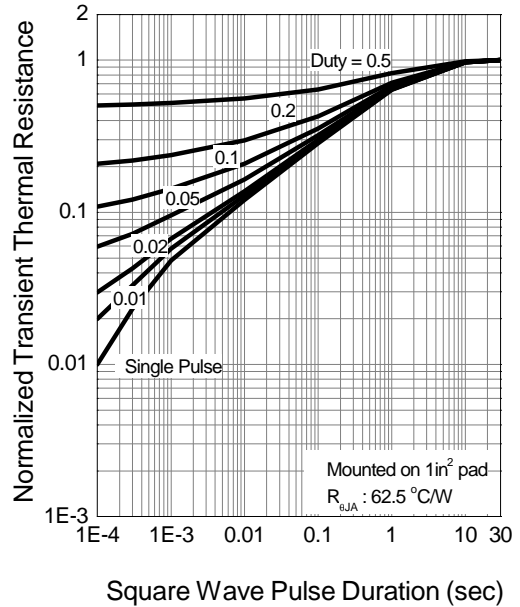

Typical Operating Characteristics (Cont.)

N-Channel

Output Characteristics

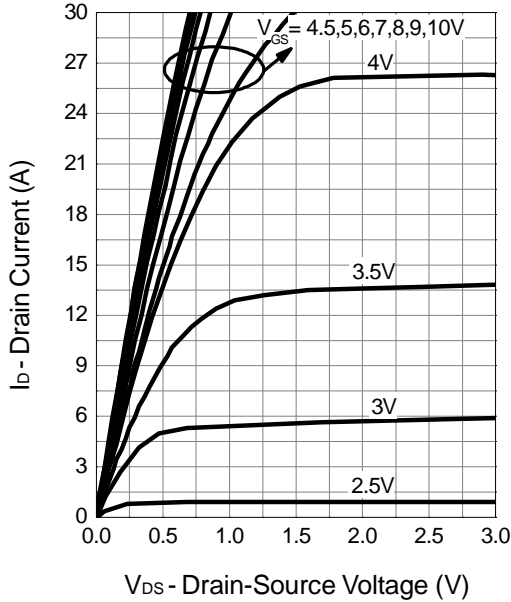

Drain-Source On Resistance

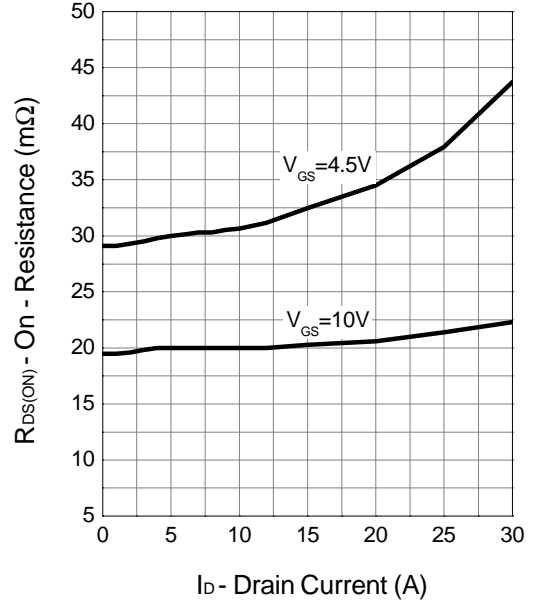

Drain-Source On Resistance

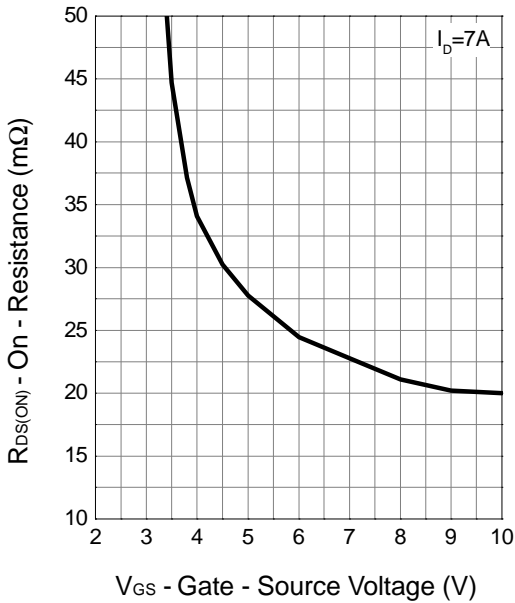

Gate Threshold Voltage

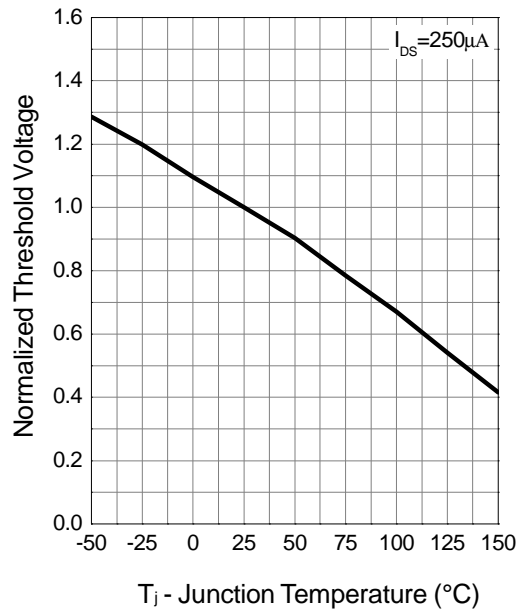

Typical Operating Characteristics (Cont.)

N-Channel

Drain-Source On Resistance

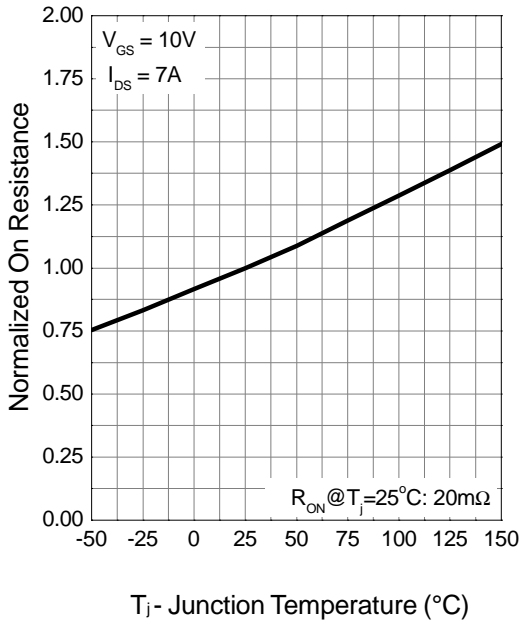

Source-Drain Diode Forward

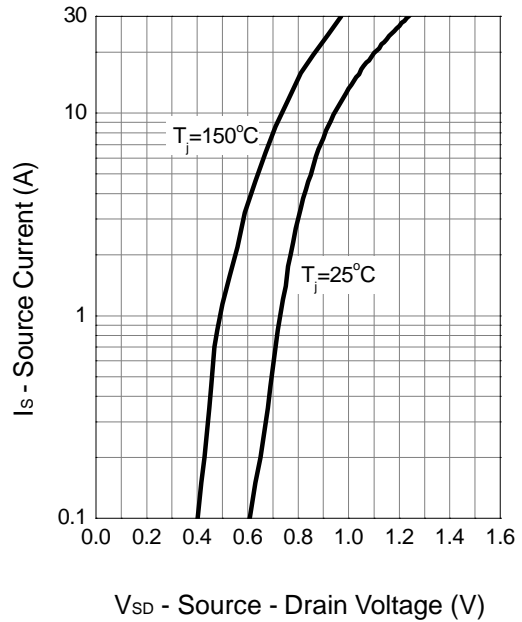

Capacitance

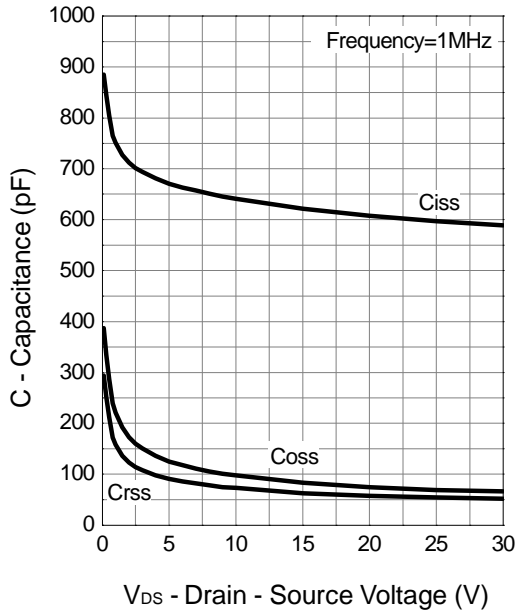

Gate Charge

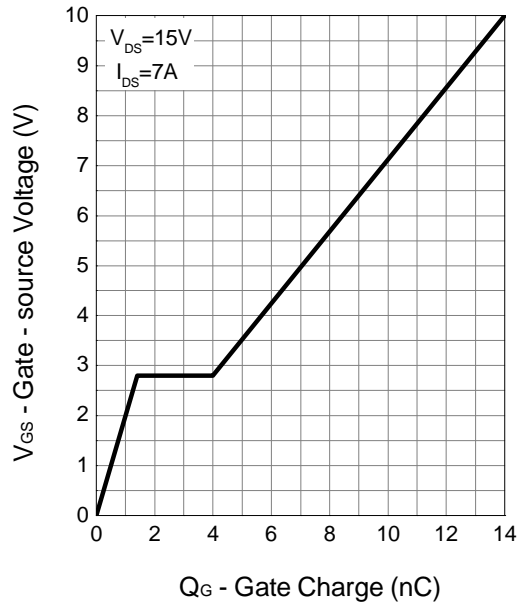

Typical Operating Characteristics (Cont.)

P-Channel

Power Dissipation

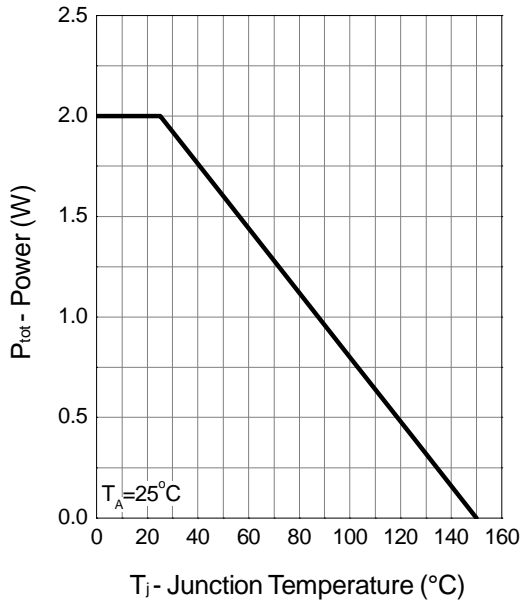

Drain Current

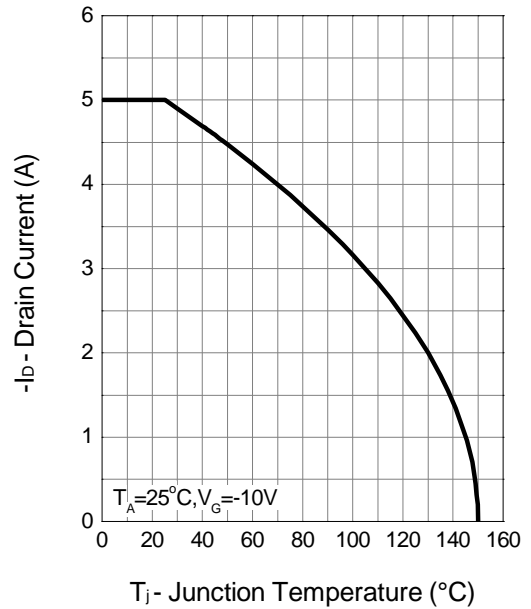

Safe Operation Area

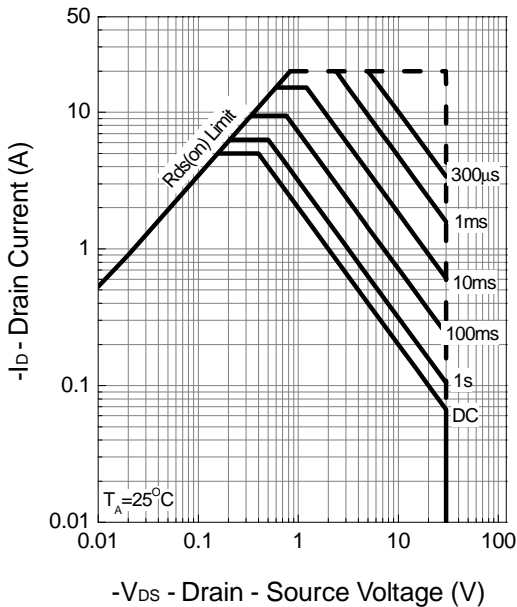

Thermal Transient Impedance

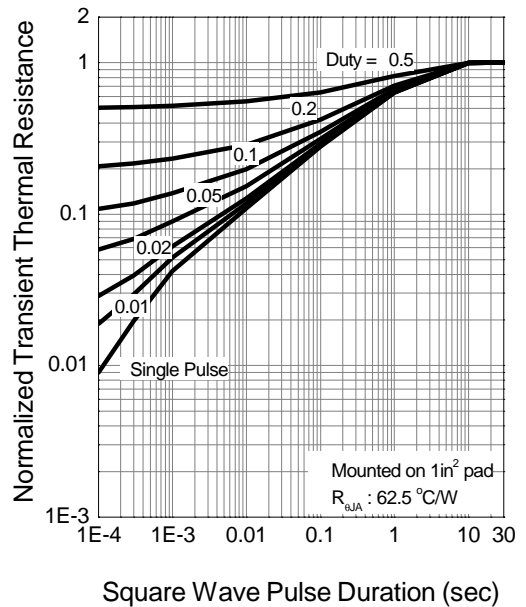

Typical Operating Characteristics (Cont.)

P-Channel

Output Characteristics

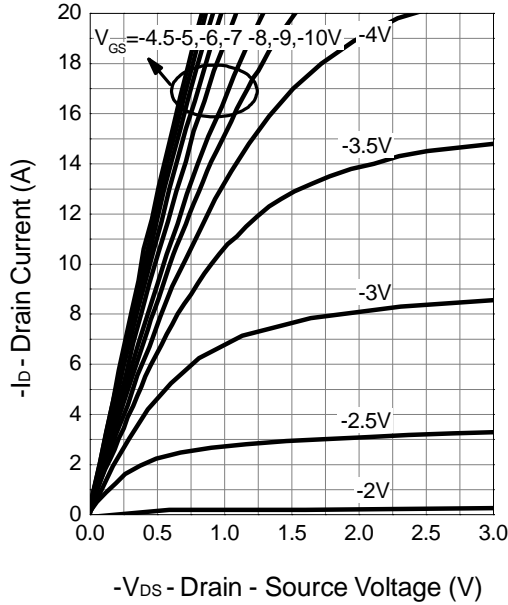

Drain-Source On Resistance

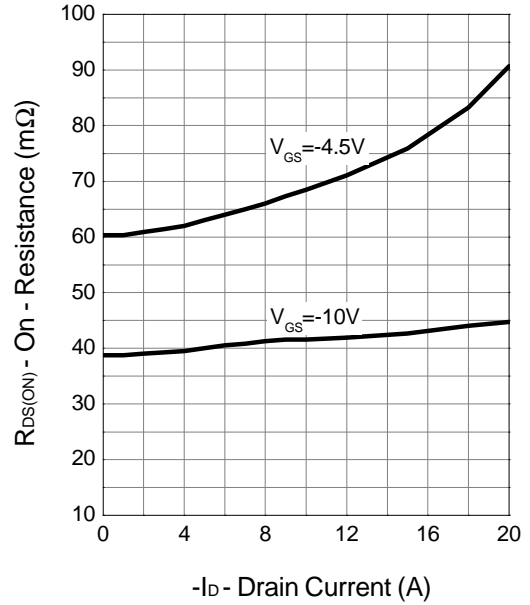

Drain-Source On Resistance

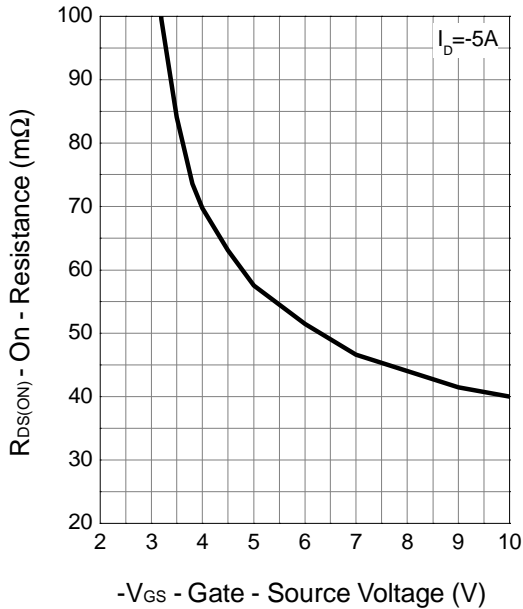

Gate Threshold Voltage

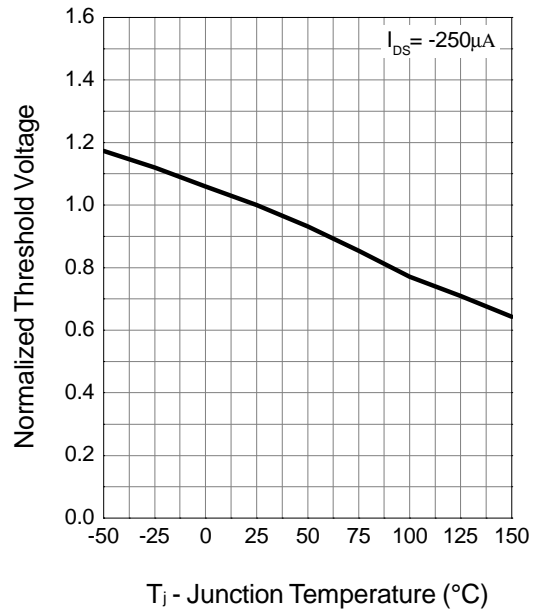

Typical Operating Characteristics (Cont.)

P-Channel

Drain-Source On Resistance

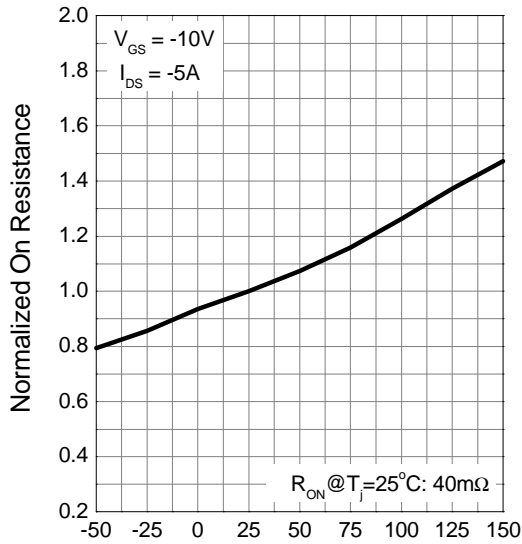

T_j - Junction Temperature (°C)

Source-Drain Diode Forward

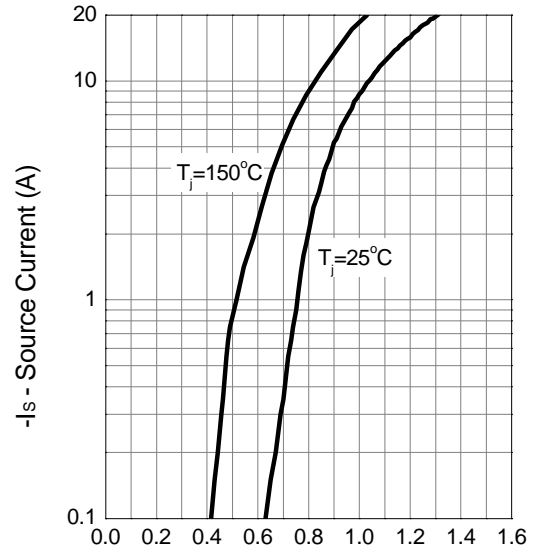

-V_{SD} - Source - Drain Voltage (V)

Capacitance

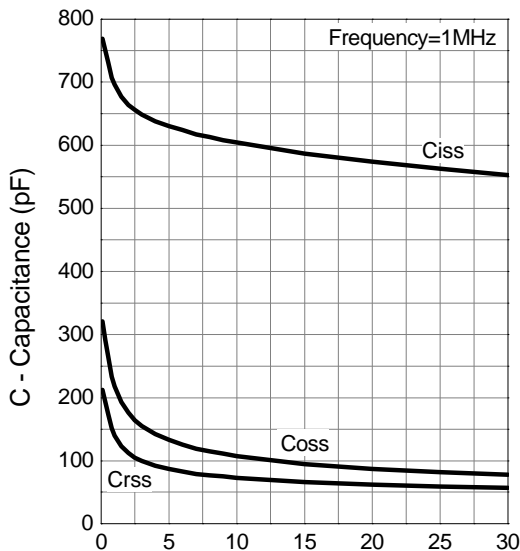

-V_{DS} - Drain - Source Voltage (V)

Gate Charge

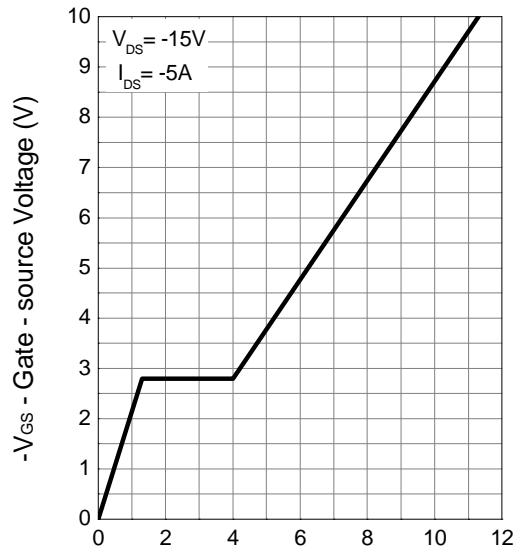

Q_G - Gate Charge (nC)

Package Information

SOP-8

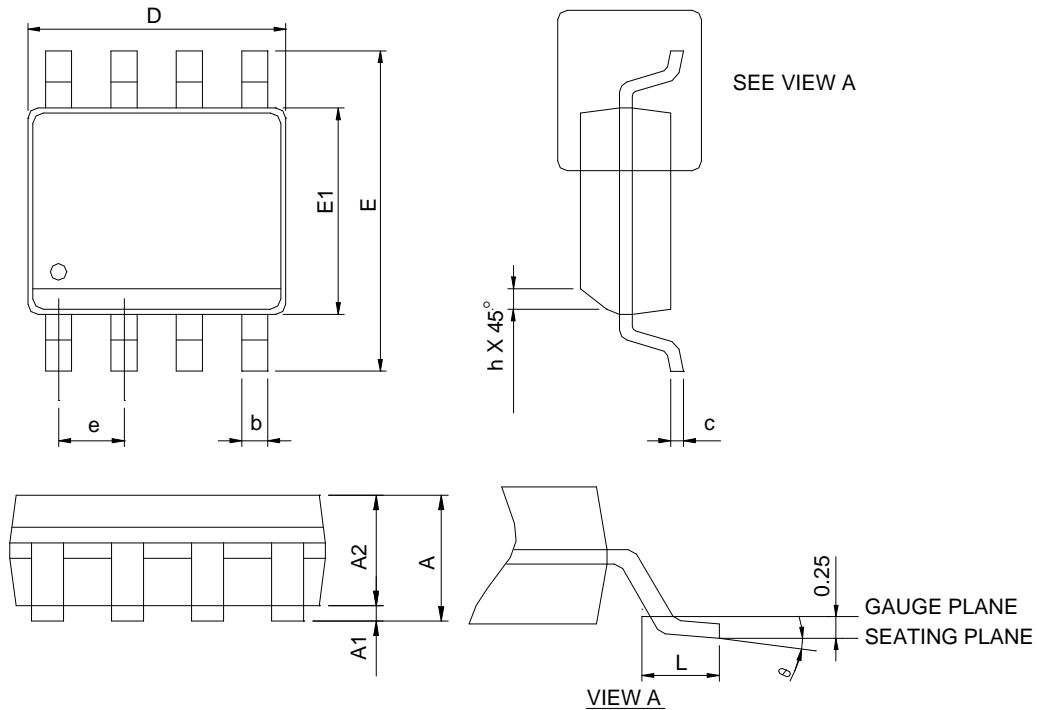

SYMBOL	SOP-8			
	MILLIMETERS		INCHES	
	MIN.	MAX.	MIN.	MAX.
A		1.75		0.069
A1	0.10	0.25	0.004	0.010
A2	1.25		0.049	
b	0.31	0.51	0.012	0.020
c	0.17	0.25	0.007	0.010
D	4.80	5.00	0.189	0.197
E	5.80	6.20	0.228	0.244
E1	3.80	4.00	0.150	0.157
e	1.27 BSC		0.050 BSC	
h	0.25	0.50	0.010	0.020
L	0.40	1.27	0.016	0.050
θ	0°	8°	0°	8°

- Note: 1. Follow JEDEC MS-012 AA.
 2. Dimension "D" does not include mold flash, protrusions or gate burrs. Mold flash, protrusion or gate burrs shall not exceed 6 mil per side.
 3. Dimension "E" does not include inter-lead flash or protrusions. Inter-lead flash and protrusions shall not exceed 10 mil per side.

Carrier Tape & Reel Dimensions

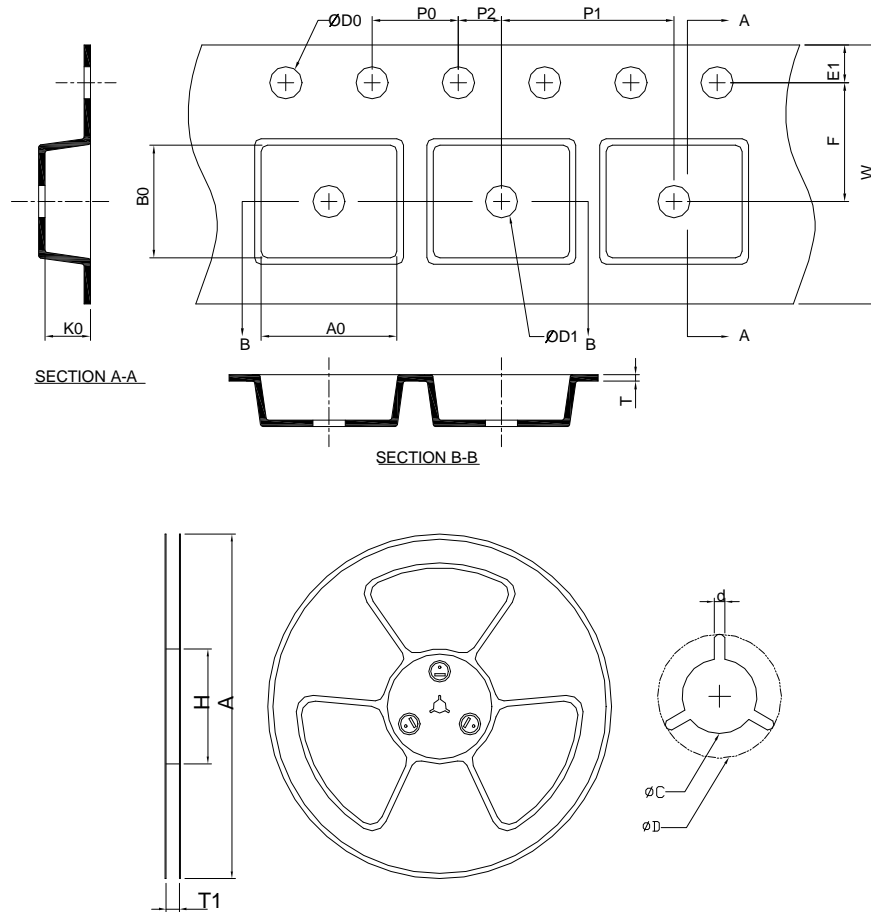

Application	A	H	T1	C	d	D	W	E1	F
SOP-8	330.0 ±2.00	50 MIN.	12.4+2.00 -0.00	13.0+0.50 -0.20	1.5 MIN.	20.2 MIN.	12.0 ±0.30	1.75 ±0.10	5.5 ±0.05
	P0	P1	P2	D0	D1	T	A0	B0	K0
	4.0 ±0.10	8.0 ±0.10	2.0 ±0.05	1.5+0.10 -0.00	1.5 MIN.	0.6+0.00 -0.40	6.40 ±0.20	5.20 ±0.20	2.10 ±0.20

(mm)

Devices Per Unit

Package Type	Unit	Quantity
SOP-8	Tape & Reel	2500

Taping Direction Information

SOP-8

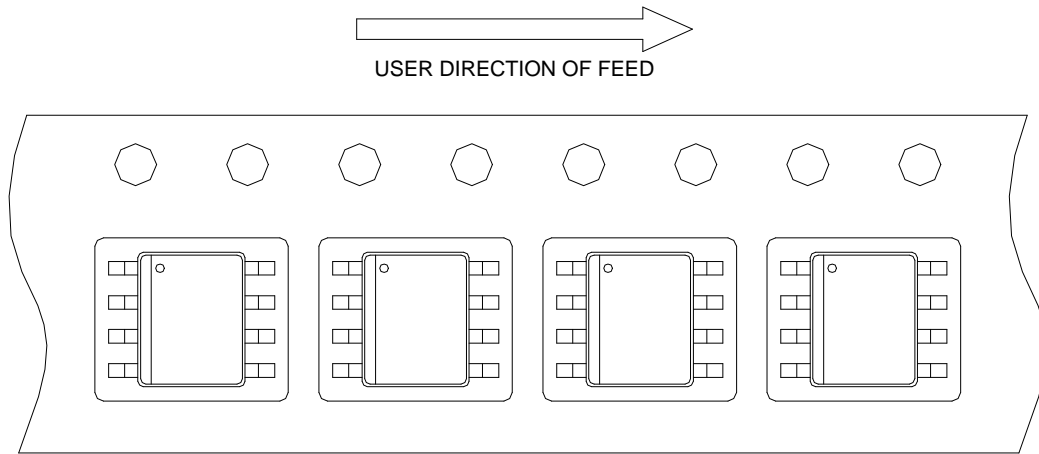

Classification Profile

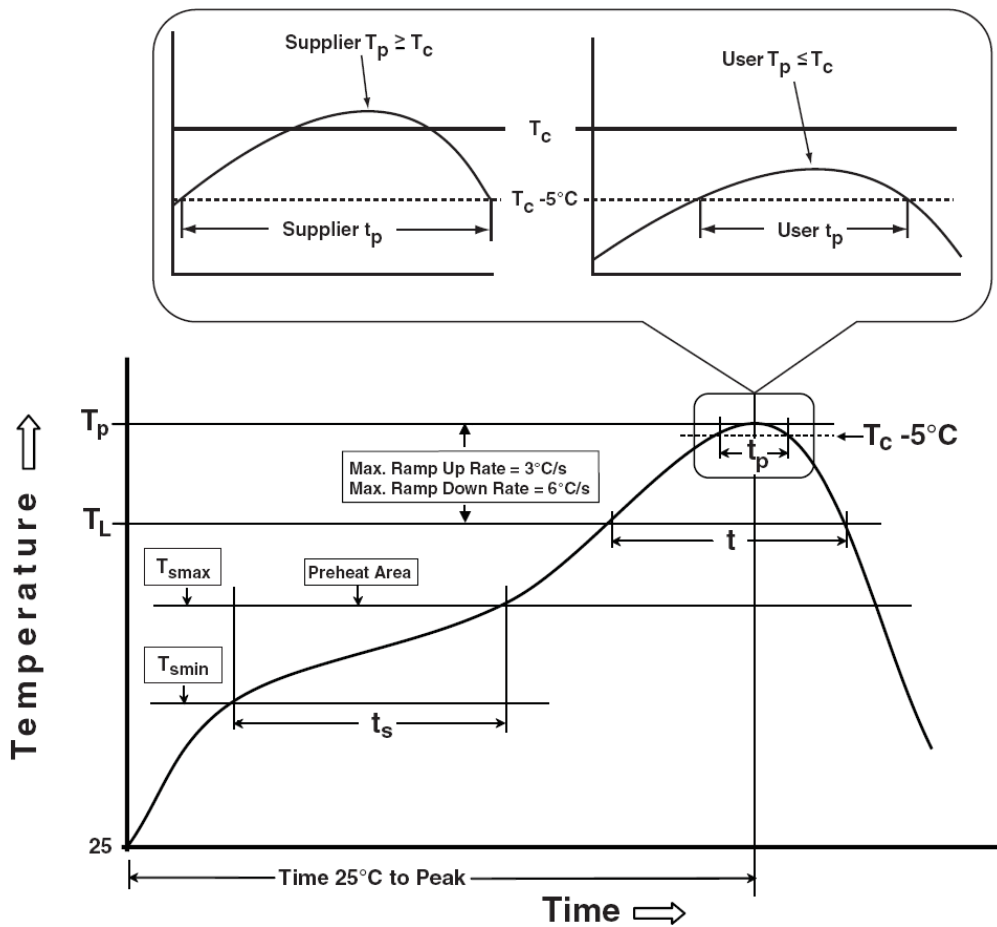

Classification Reflow Profiles

Profile Feature	Sn-Pb Eutectic Assembly	Pb-Free Assembly
Preheat & Soak		
Temperature min (T_{smin})	100 °C	150 °C
Temperature max (T_{smax})	150 °C	200 °C
Time (T_{smin} to T_{smax}) (t_s)	60-120 seconds	60-120 seconds
Average ramp-up rate (T_{smax} to T_p)	3 °C/second max.	3°C/second max.
Liquidous temperature (T_L)	183 °C	217 °C
Time at liquidous (t_L)	60-150 seconds	60-150 seconds
Peak package body Temperature (T_p)*	See Classification Temp in table 1	See Classification Temp in table 2
Time (t_p)** within 5°C of the specified classification temperature (T_c)	20** seconds	30** seconds
Average ramp-down rate (T_p to T_{smax})	6 °C/second max.	6 °C/second max.
Time 25°C to peak temperature	6 minutes max.	8 minutes max.
* Tolerance for peak profile Temperature (T_p) is defined as a supplier minimum and a user maximum.		
** Tolerance for time at peak profile temperature (t_p) is defined as a supplier minimum and a user maximum.		

Table 1. SnPb Eutectic Process – Classification Temperatures (T_c)

Package Thickness	Volume mm ³ <350	Volume mm ³ ≥350
<2.5 mm	235 °C	220 °C
≥2.5 mm	220 °C	220 °C

Table 2. Pb-free Process – Classification Temperatures (T_c)

Package Thickness	Volume mm ³ <350	Volume mm ³ 350-2000	Volume mm ³ >2000
<1.6 mm	260 °C	260 °C	260 °C
1.6 mm – 2.5 mm	260 °C	250 °C	245 °C
≥2.5 mm	250 °C	245 °C	245 °C

Reliability Test Program

Test item	Method	Description
SOLDERABILITY	JESD-22, B102	5 Sec, 245°C
HOLT	JESD-22, A108	1000 Hrs, Bias @ 125°C
PCT	JESD-22, A102	168 Hrs, 100%RH, 2atm, 121°C
TCT	JESD-22, A104	500 Cycles, -65°C~150°C

Customer Service

Anpec Electronics Corp.

Head Office :

No.6, Dusing 1st Road, SBIP,

Hsin-Chu, Taiwan, R.O.C.

Tel : 886-3-5642000

Fax : 886-3-5642050

Taipei Branch :

2F, No. 11, Lane 218, Sec 2 Jhongsing Rd.,

Sindain City, Taipei County 23146, Taiwan

Tel : 886-2-2910-3838

Fax : 886-2-2917-3838