

Part Number	Relay Description
C60-X0	Solid-State Relay, Terminals for Through Hole Mount
SC60-X0	Solid-State Relay, Terminals for Surface Mount

Add suffix 01 to denote 60Sn/40Pb Pre-Tinned Leads

ELECTRICAL SPECIFICATIONS

(25°C UNLESS OTHERWISE SPECIFIED)

INPUT (CONTROL) SPECIFICATIONS (See Note 1)

Parameter	Min	Max	Units
Input Voltage Drop (See Figure 1)	1.1	1.5	Vdc
Input Current (See Figure 1 and Notes 1, 7)		50	mA
Input Current (Guaranteed On), (See Figure 4 and Note 7)	10		mA
Input Current (Guaranteed Off)		100	µA
Reverse Voltage Protection		-6	Vdc

OUTPUT (LOAD) SPECIFICATIONS (See Figure 2 And Note 2)

Parameter	Part Number	DC		Bi-Directional		Units
		Min	Max	Min	Max	
Output Voltage Rating	C60-10	60		±60		Vdc
	C60-20	100		±100		Vdc
	C60-30	200		±200		Vdc
	C60-40	400		±400		Vdc
Output Current Rating	C60-10	2.5		±1.25		Adc
	C60-20	1.5		±0.75		Adc
	C60-30	1.0		±0.50		Adc
	C60-40	0.5		±0.25		Adc
On Resistance (See Note 6)	C60-10	0.07		0.28		Ohm
	C60-20	0.2		0.7		Ohm
	C60-30	0.45		1.8		Ohm
	C60-40	1.0		4.0		Ohm
Leakage Current at Rated Voltage		2.0		1.0		µAdc
Turn-On Time @ 10mA (See Figure 4 and Note 7)	C60-10	4.0		4.0		ms
	C60-20,-30,-40	3.0		3.0		ms
Turn-Off Time	C60-10	4.0		4.0		ms
	C60-20,-30,-40	3.0		3.0		ms
Output Capacitance	C60-10	1000		500		pf
	C60-20	500		250		pf
	C60-30	400		200		pf
	C60-40	400		200		pf
Isolation (Input to Output)		10 ⁹		10 ⁹		Ohms
Dielectric Strength		1500		1500		Vrms
Capacitance (Input to Output)		3.0		3.0		pF
Junction Temperature (T _j)		125		125		°C
Junction to Case Thermal Resistance				25		°C
Case to Ambient Thermal Resistance				75		°C/W

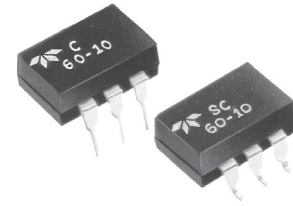

FEATURES/BENEFITS

- Power FET Output with Very Low On Resistance: Virtually no offset with very low leakage and voltage drop.
- Optical Isolation: Isolates control elements from load transients. Eliminates ground loops and signal ground noise.
- Three Terminal Output: Output FETs can be paralleled externally to change current load rating.
- Floating Output: Allows for high and low side switching.
- Switches High Voltages and Currents: Voltages to 400 Vdc. Current to 2.5 Adc. Bi-directional, DC or AC.
- High Noise Immunity: Control circuit cannot be triggered by output switching noise.
- 6-Pin Mini-DIP Package: Standard or surface mount available.

DESCRIPTION

The Series C60 solid-state relay is an advanced design capable of switching very heavy loads in a physically small 6-pin mini DIP package. These relays have a power FET output that ensures low On resistance, no offset voltage and low leakage current. They are versatile and can be used to switch AC, Bi-directional or DC loads. Optical isolation ensures complete protection of signal lines, power and ground bus and control circuits from switching noise and EMI.

BLOCK DIAGRAM

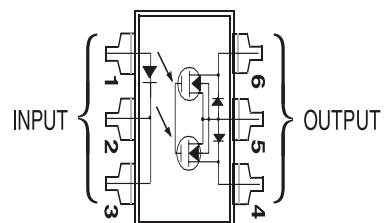

CHARACTERISTIC CURVES

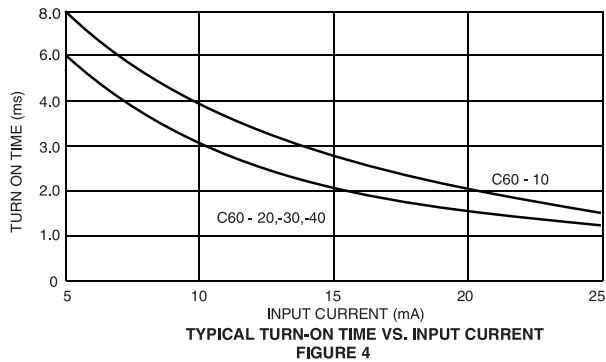
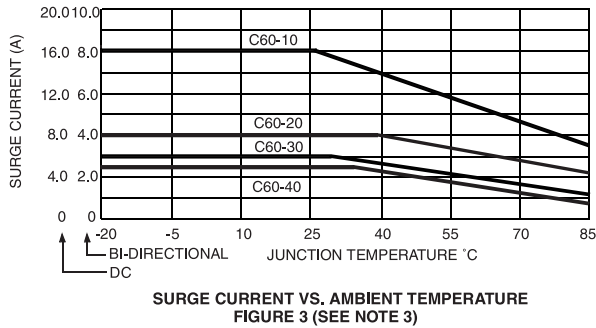
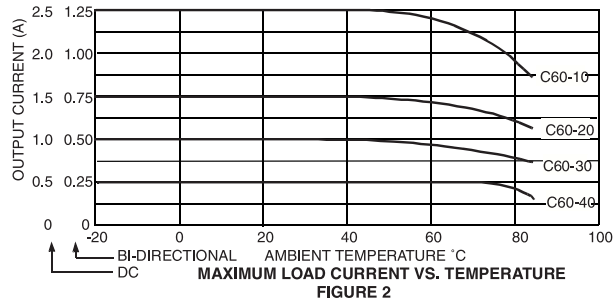
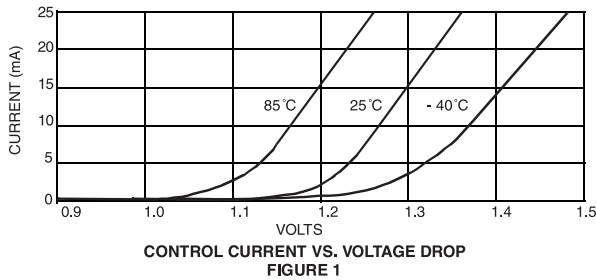

MECHANICAL SPECIFICATION

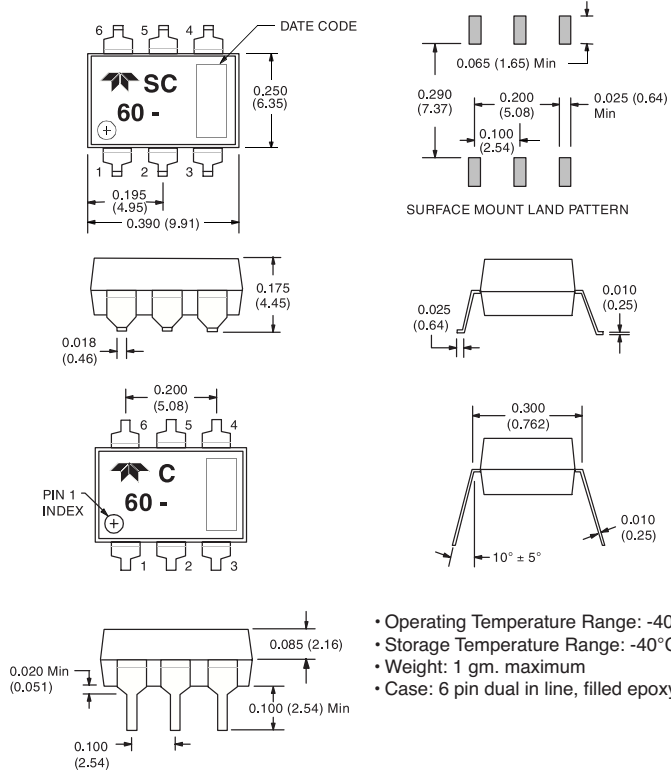

- Operating Temperature Range: -40°C to 85°C
- Storage Temperature Range: -40°C to 100°C
- Weight: 1 gm. maximum
- Case: 6 pin dual in line, filled epoxy

WIRING CONFIGURATIONS

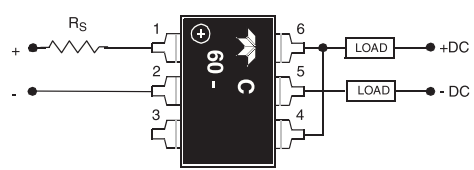
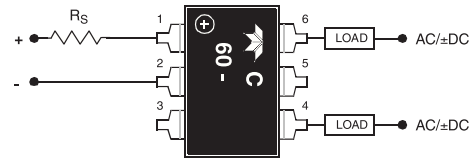

- NOTES:**
1. Series resistor is required to limit input current to 50 mA maximum.
 2. The input current is 10 mA for all tests unless otherwise specified.
 3. The surge current is non-repetitive for a maximum duration of 20 ms (See Figure 3).
 4. Loads may be connected to positive or negative referenced power supplies. Inductive loads must be diode suppressed.
 5. Continuous load current is rated under the conditions of still air and mounted on a printed circuit board.
 6. To calculate ON Resistance for a given junction temperature calculate the new R_{ON} using the equation shown below:

$$R_{ON} = R_{(25^{\circ}C)} \times e^{0.006(T_J - 25^{\circ}C)}$$
 7. Turn on Time can be controlled with input control current. Calculate a new turn-on time:

$$t_{ON} = (t_{Specification\ Limit}) (10\text{mA} / I_{IN})$$
 8. Load voltage rating should be derated 10% at -40°C