

HER801 THRU HER808

GLASS PASSIVATED HIGH EFFICIENCY RECTIFIERS

Reverse Voltage – 50 to 1000 Volts

Forward Current – 8.0 Amperes

Features

- Plastic package has Underwriters Laboratory Flammability Classification 94V-0 utilizing Flame Retardant Epoxy Molding Compound
- Low power loss, high efficiency
- Low forward voltage, high current capability
- High surge capacity
- Ultra Fast recovery times, high voltage

Mechanical Data

- **Case:** Molded plastic TO-220A
- **Mounting position:** Any
- **Terminals:** Leads solderable per MIL-STD-202, method 208 guaranteed
- **Polarity:** as marked

TO-220A

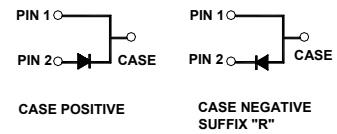
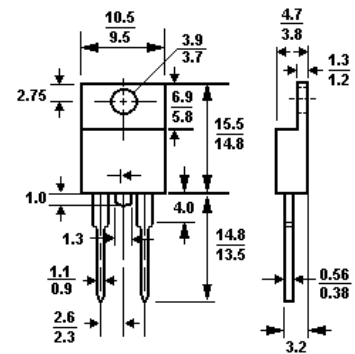

Dimensions in mm

Maximum Ratings and Electrical Characteristics

Ratings at 25°C ambient temperature unless otherwise specified. Single-phase, half wave, 60Hz, resistive or inductive load. For capacitive load, derate current by 20%.

	Symbols	HER 801	HER 802	HER 803	HER 804	HER 805	HER 806	HER 807	HER 808	Units
Maximum recurrent peak reverse voltage	V_{RRM}	50	100	200	300	400	600	800	1000	V
Maximum RMS voltage	V_{RMS}	35	70	140	210	280	420	560	700	V
Maximum DC blocking voltage	V_{DC}	50	100	200	300	400	600	800	1000	V
Maximum average forward rectified current .375"(9.5mm) lead length at $T_C = 100^\circ C$	$I_{(AV)}$	8.0								A
Peak forward surge current , 8.3ms single half sine-wave superimposed on rated load (JEDEC method)	I_{FSM}	150								A
Maximum forward voltage @ 8.0A	V_F	1.0		1.3		1.7				V
Maximum reverse current @ $T_A = 25^\circ C$ at rated DC blocking voltage @ $T_A = 125^\circ C$	I_R I_R	10				500				uA uA
Typical junction capacitance (Note 1)	C_J	80				50				pF
Maximum reverse recovery time (Note 2)	T_{rr}	50				80				nS
Typical thermal resistance (Note3)	$R_{\theta JC}$	3.0								$^\circ C/W$
Operating temperature range	T_J	-55 to +150								$^\circ C$
Storage temperature range	T_S	-55 to +150								$^\circ C$

- Note: 1. Measured at 1 MHz and applied reverse voltage of 4.0 Volts D.C.
2. Reverse recovery test conditions: $I_F = 0.5A$, $I_R = 1.0A$, $I_{RR} = 0.25A$.
3. Thermal Resistance from junction to case mounted on heat sink.

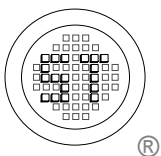

SEMTECH ELECTRONICS LTD.

(Subsidiary of Semtech International Holdings Limited, a company listed on the Hong Kong Stock Exchange, Stock Code: 724)

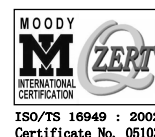

ISO/TS 16949 : 2002
Certificate No. 05103



ISO 14001
Certificate No. 7116



ISO 9001 : 2000
Certificate No. 655-195-000-000

Dated : 24/09/2003

HER801 THRU HER808

RATINGS AND CHARACTERISTIC CURVES

REVERSE RECOVERY TIME CHARACTERISTIC AND TEST CIRCUIT DIAGRAM

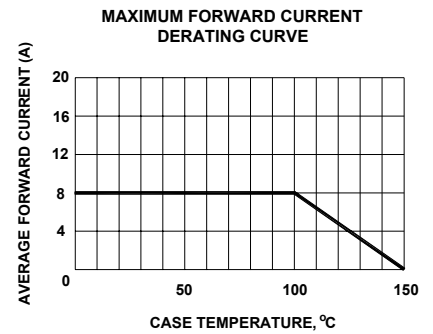
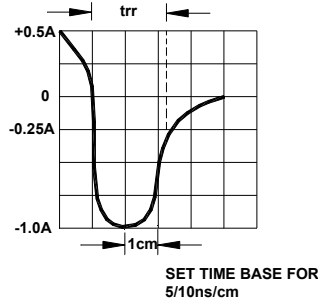
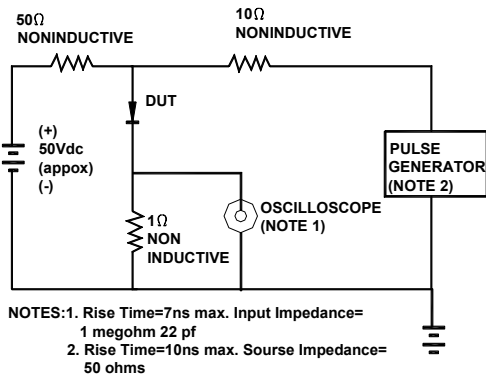

TYPICAL REVERSE CHARACTERISTICS

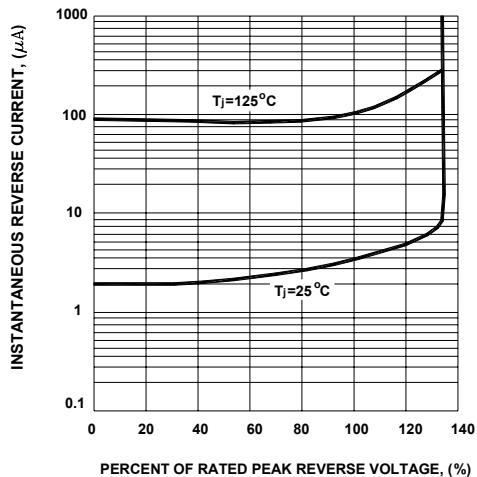

Fig. 4-TYPICAL FORWARD CHARACTERISTICS

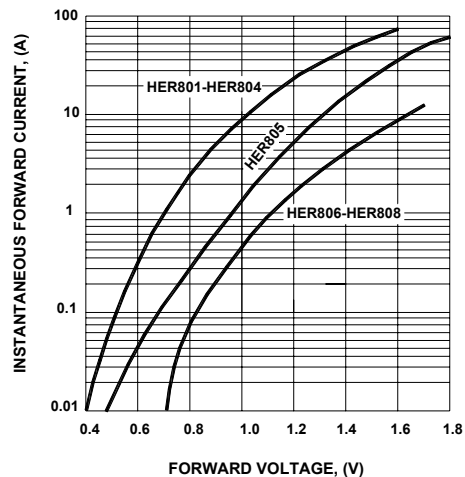

Fig. 5-MAXIMUM NON-REPETITIVE FORWARD SURGE CURRENT

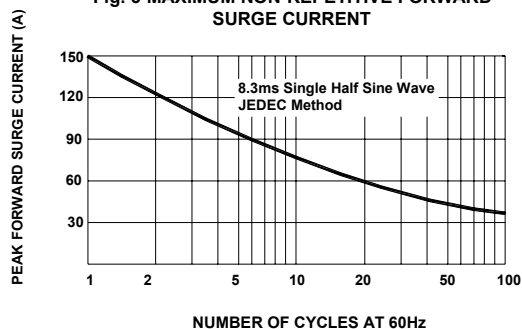
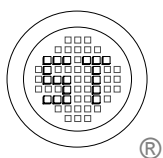
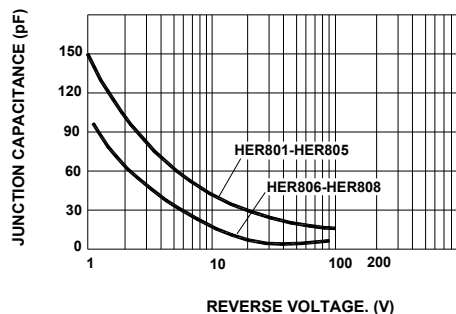

Fig. 6-TYPICAL JUNCTION CAPACITANCE



SEMTECH ELECTRONICS LTD.
(Subsidiary of Semtech International Holdings Limited, a company listed on the Hong Kong Stock Exchange, Stock Code: 724)

