



| Parameter | Ratings | Units |
|---------------------|---------|------------------------|
| Blocking Voltage | 350 | V_P |
| Load Current | 120 | mA_{rms} & mA_{DC} |
| On-Resistance (max) | 25 | Ω |

Features

- 3750V_{rms} Input/Output Isolation
- Low Drive Power Requirements (TTL/CMOS Compatible)
- No Moving Parts
- High Reliability
- Arc-Free With No Snubbing Circuits
- FCC Compatible
- VDE Compatible
- No EMI/RFI Generation
- Small 6-Pin DIP Package
- Machine Insertable, Wave Solderable
- Surface Mount Tape & Reel Version Available

Applications

- Telecommunications
 - Telecom Switching
 - Tip/Ring Circuits
 - Modem Switching (Laptop, Notebook, Pocket Size)
 - Hook Switch
 - Dial Pulsing
 - Ground Start
 - Ringing Injection
- Instrumentation
 - Multiplexers
 - Data Acquisition
 - Electronic Switching
 - I/O Subsystems
- Meters (Watt-Hour, Water, Gas)
- Medical Equipment—Patient/Equipment Isolation
- Security
- Aerospace
- Industrial Controls

Description

The LCA100 is a 350V, 120mA, 25 Ω , normally open (1-Form-A) relay. It features one of the lowest on-resistances available in a 350V OptoMOS relay.

Approvals

- UL Recognized Component: File # E76270
- CSA Certified Component: Certificate # 1172007
- EN/IEC 60950 Certified Component: TUV Certificate # B 09 07 49410 004

Ordering Information

| Part # | Description |
|-----------|----------------------------------|
| LCA100 | 6-Pin DIP (50/Tube) |
| LCA100S | 6-Pin Surface Mount (50/Tube) |
| LCA100STR | 6-Pin Surface Mount (1,000/Reel) |

Pin Configuration

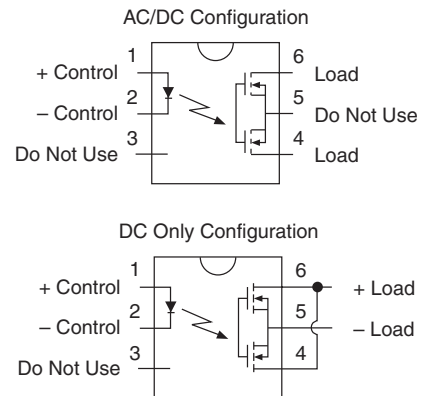

Switching Characteristics of Normally Open Devices

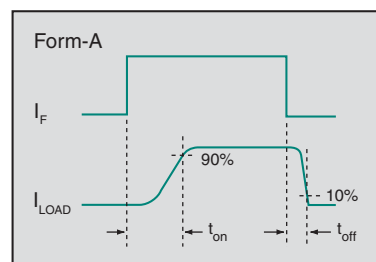

Absolute Maximum Ratings @ 25° C

| Parameter | Ratings | Units |
|--------------------------------------|-------------|------------------|
| Blocking Voltage | 350 | V _P |
| Reverse Input Voltage | 5 | V |
| Input Control Current Peak (10ms) | 50 | mA |
| | 1 | A |
| Input Power Dissipation ¹ | 150 | mW |
| Total Power Dissipation ² | 800 | mW |
| Isolation Voltage, Input to Output | 3750 | V _{rms} |
| Operational Temperature | -40 to +85 | °C |
| Storage Temperature | -40 to +125 | °C |

Absolute Maximum Ratings are stress ratings. Stresses in excess of these ratings can cause permanent damage to the device. Functional operation of the device at conditions beyond those indicated in the operational sections of this data sheet is not implied.

¹ Derate linearly 1.33 mW / °C

² Derate linearly 6.67 mW / °C

Electrical Characteristics @ 25°C

| Parameter | Conditions | Symbol | Min | Typ | Max | Units |
|--|--|-------------------|-----|-----|-----|--------------------------------------|
| Output Characteristics | | | | | | |
| Load Current | | | | | | |
| AC/DC Configuration, Continuous ¹ | - | I _L | - | - | 120 | mA _{rms} & mA _{DC} |
| DC Configuration, Continuous ¹ | - | I _L | - | - | 200 | mA _{DC} |
| Peak | 10ms | I _{LPK} | - | - | 350 | mA _P |
| On-Resistance ² | | | | | | |
| AC/DC Configuration | I _L =120mA | R _{ON} | - | - | 25 | Ω |
| DC Configuration | I _L =200mA | | - | - | 8 | |
| Off-State Leakage Current | V _L =350V | I _{LEAK} | - | - | 1 | μA |
| Switching Speeds | | | | | | |
| Turn-On | I _F = 5mA, V _L = 10V | t _{on} | - | - | 5 | ms |
| Turn-Off | | t _{off} | - | - | 5 | ms |
| Output Capacitance | 50V, f=1MHz | C _{OUT} | - | 35 | - | pF |
| Input Characteristics | | | | | | |
| Input Control Current to Activate | I _L = 120mA | I _F | - | - | 5 | mA |
| Input Control Current to Deactivate | - | I _F | 0.4 | 0.7 | - | mA |
| Input Voltage Drop | I _F = 5mA | V _F | 0.9 | 1.2 | 1.4 | V |
| Reverse Input Current | V _R = 5V | I _R | - | - | 10 | μA |
| Common Characteristics | | | | | | |
| Capacitance, Input to Output | - | C _{I/O} | - | 3 | - | pF |

¹ If both poles operate, then the load current must be derated so that the package power dissipation value is not exceeded.

² Measurement taken within 1 second of on-time.

PERFORMANCE DATA @25°C (Unless Otherwise Noted)*

Typical LED Forward Voltage Drop
(N=50, I_F=5mA)

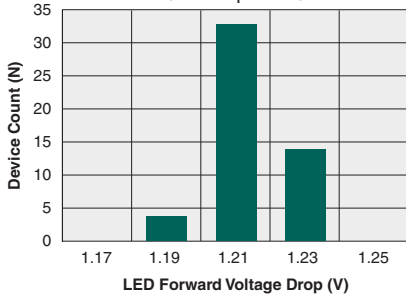

Typical Turn-On Time
(N=50, I_F=5mA, I_L=120mA_{DC})

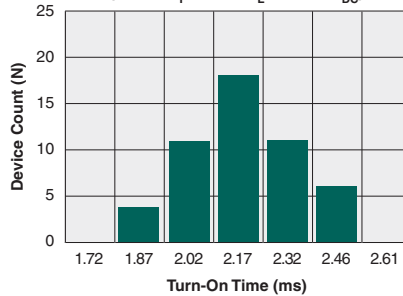

Typical Turn-Off Time
(N=50, I_F=5mA, I_L=120mA_{DC})

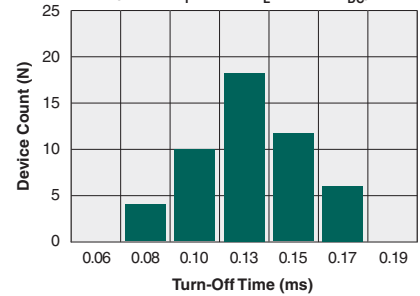

Typical I_F for Switch Operation
(N=50, I_L=120mA_{DC})

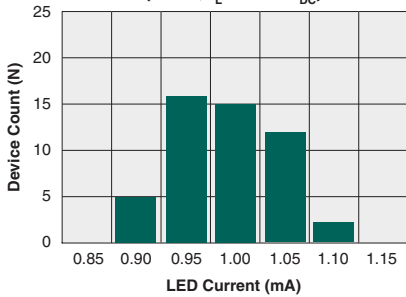

Typical I_F for Switch Dropout
(N=50, I_L=120mA_{DC})

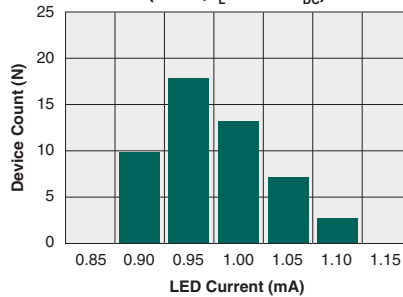

Typical On-Resistance Distribution
(N=50, I_L=120mA_{DC})

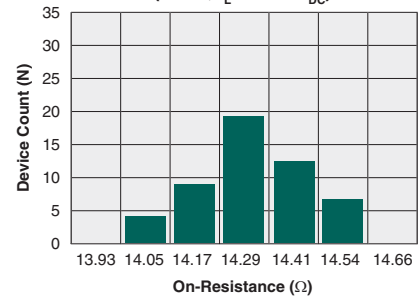

Typical Blocking Voltage Distribution
(N=50)

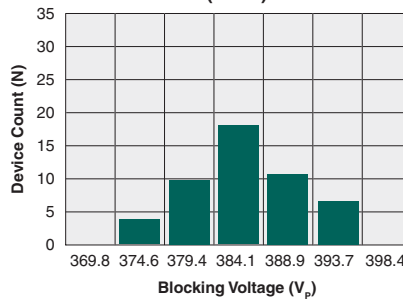

Typical LED Forward Voltage Drop vs. Temperature

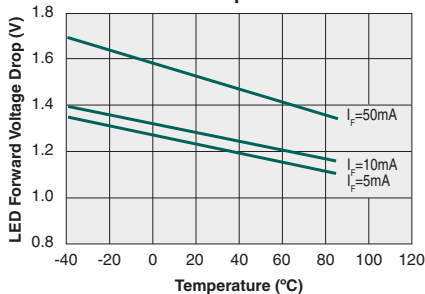

Typical Turn-On Time vs. LED Forward Current
(I_L=130mA_{DC})

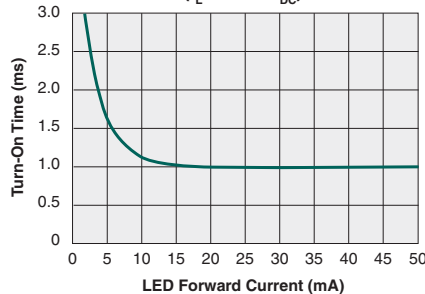

Typical Turn-Off Time vs. LED Forward Current
(I_L=130mA_{DC})

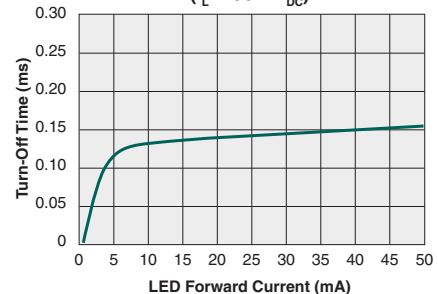

*The Performance data shown in the graphs above is typical of device performance. For guaranteed parameters not indicated in the written specifications, please contact our application department.

PERFORMANCE DATA @25°C (Unless Otherwise Noted)*

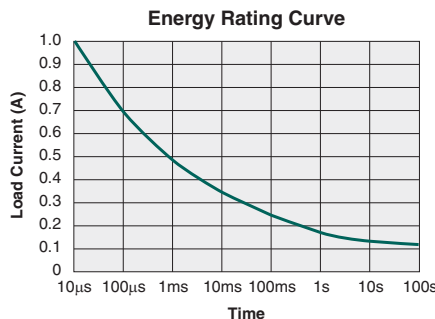
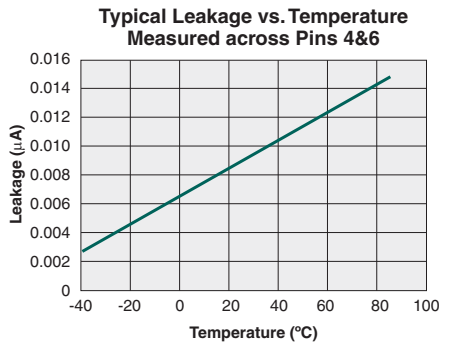
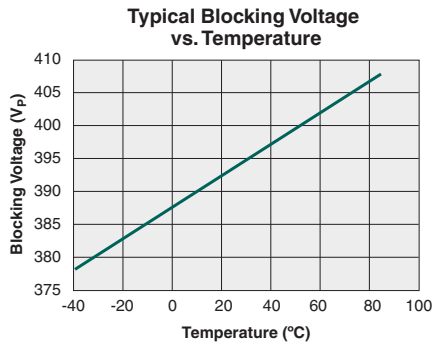
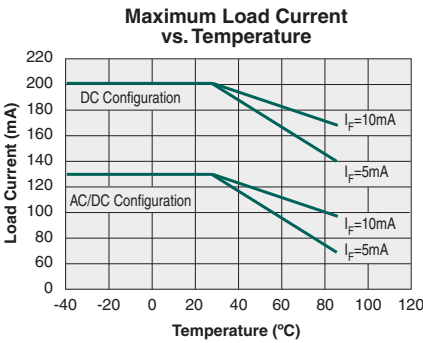
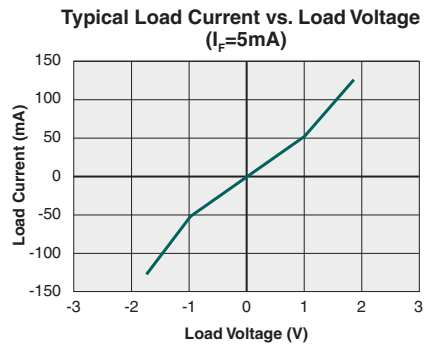
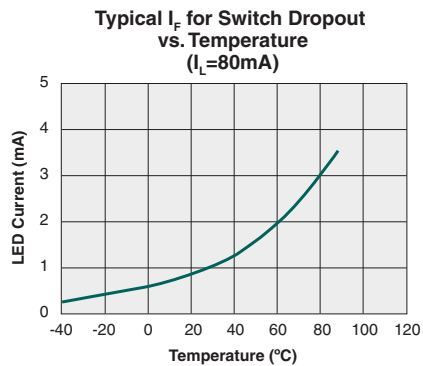
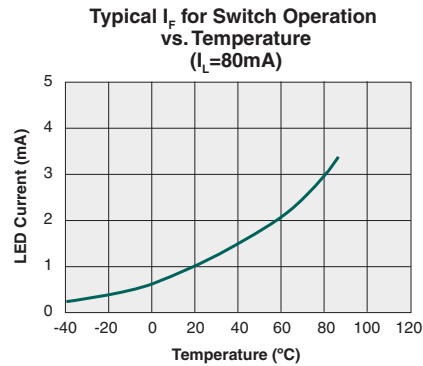
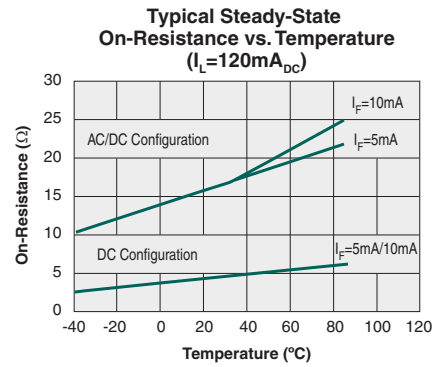
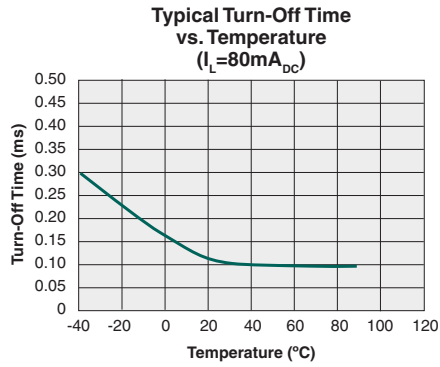
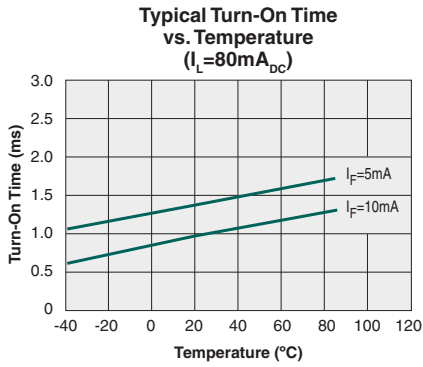

*The Performance data shown in the graphs above is typical of device performance. For guaranteed parameters not indicated in the written specifications, please contact our application department.

Manufacturing Information

Moisture Sensitivity



All plastic encapsulated semiconductor packages are susceptible to moisture ingress. IXYS Integrated Circuits Division classified all of its plastic encapsulated devices for moisture sensitivity according to the latest version of the joint industry standard, **IPC/JEDEC J-STD-020**, in force at the time of product evaluation. We test all of our products to the maximum conditions set forth in the standard, and guarantee proper operation of our devices when handled according to the limitations and information in that standard as well as to any limitations set forth in the information or standards referenced below.

Failure to adhere to the warnings or limitations as established by the listed specifications could result in reduced product performance, reduction of operable life, and/or reduction of overall reliability.

This product carries a **Moisture Sensitivity Level (MSL) rating** as shown below, and should be handled according to the requirements of the latest version of the joint industry standard **IPC/JEDEC J-STD-033**.

| Device | Moisture Sensitivity Level (MSL) Rating |
|------------------|---|
| LCA100 / LCA100S | MSL 1 |

ESD Sensitivity



This product is **ESD Sensitive**, and should be handled according to the industry standard **JESD-625**.

Reflow Profile

This product has a maximum body temperature and time rating as shown below. All other guidelines of **J-STD-020** must be observed.

| Device | Maximum Temperature x Time |
|------------------|----------------------------|
| LCA100 / LCA100S | 250°C for 30 seconds |

Board Wash

IXYS Integrated Circuits Division recommends the use of no-clean flux formulations. However, board washing to remove flux residue is acceptable. Since IXYS Integrated Circuits Division employs the use of silicone coating as an optical waveguide in many of its optically isolated products, the use of a short drying bake could be necessary if a wash is used after solder reflow processes. Chlorine- or Fluorine-based solvents or fluxes should not be used. Cleaning methods that employ ultrasonic energy should not be used.



MECHANICAL DIMENSIONS

LCA100

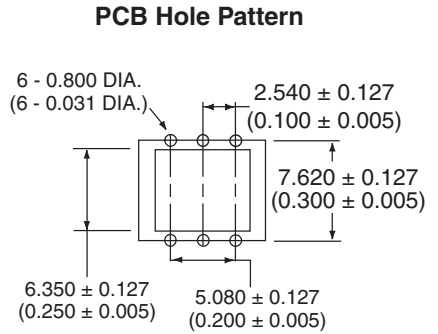
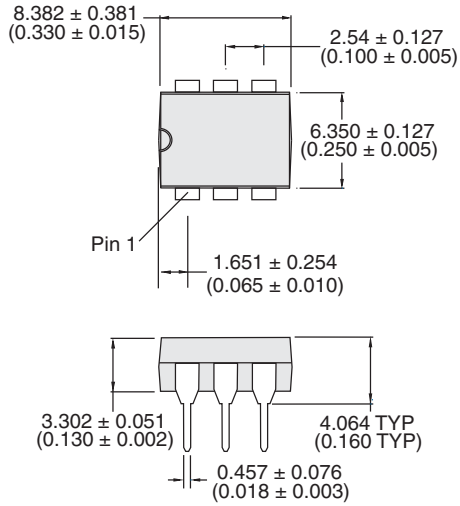

Dimensions
mm
(inches)

LCA100S

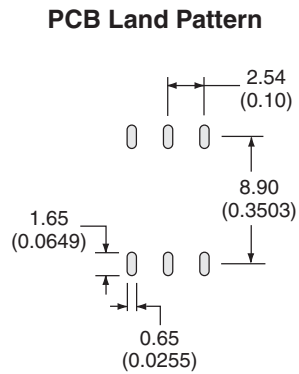
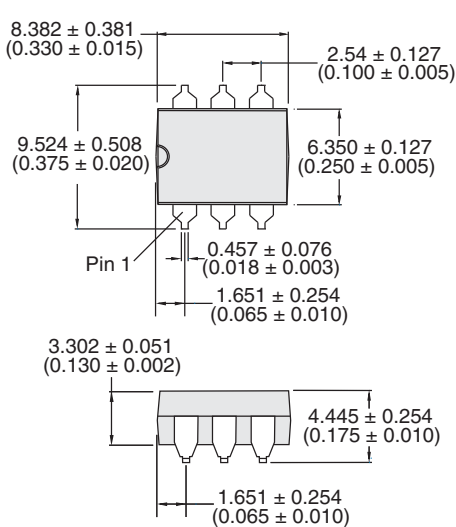

Dimensions
mm
(inches)

LCA100STR Tape & Reel

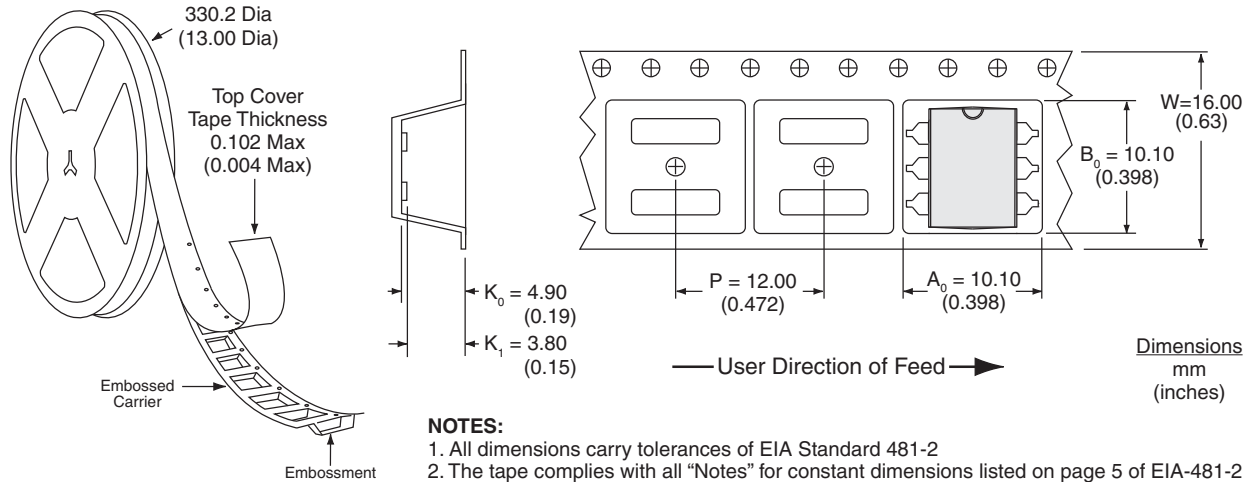

For additional information please visit our website at: www.ixysic.com

IXYS Integrated Circuits Division makes no representations or warranties with respect to the accuracy or completeness of the contents of this publication and reserves the right to make changes to specifications and product descriptions at any time without notice. Neither circuit patent licenses nor indemnity are expressed or implied. Except as set forth in IXYS Integrated Circuits Division's Standard Terms and Conditions of Sale, IXYS Integrated Circuits Division assumes no liability whatsoever, and disclaims any express or implied warranty, relating to its products including, but not limited to, the implied warranty of merchantability, fitness for a particular purpose, or infringement of any intellectual property right.

The products described in this document are not designed, intended, authorized or warranted for use as components in systems intended for surgical implant into the body, or in other applications intended to support or sustain life, or where malfunction of IXYS Integrated Circuits Division's product may result in direct physical harm, injury, or death to a person or severe property or environmental damage. IXYS Integrated Circuits Division reserves the right to discontinue or make changes to its products at any time without notice.