

PolarHT™ HiPerFET Power MOSFET

IXFH 96N15P
IXFV 96N15P
IXFV 96N15PS

$V_{DSS} = 150 \text{ V}$
 $I_{D25} = 96 \text{ A}$
 $R_{DS(on)} = 24 \text{ m}\Omega$
 $t_{rr} < 200 \text{ ns}$

N-Channel Enhancement Mode

Preliminary Data Sheet

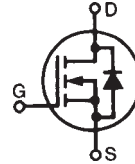

Symbol	Test Conditions	Maximum Ratings	
V_{DSS}	$T_J = 25^\circ\text{C}$ to 175°C	150	V
V_{DGR}	$T_J = 25^\circ\text{C}$ to 175°C ; $R_{GS} = 1 \text{ M}\Omega$	150	V
V_{GS}	Continuous	± 20	V
V_{GSM}	Transient	± 30	V
I_{D25}	$T_C = 25^\circ\text{C}$	96	A
$I_{D(RMS)}$	External lead current limit	75	A
I_{DM}	$T_C = 25^\circ\text{C}$, pulse width limited by T_{JM}	250	A
I_{AR}	$T_C = 25^\circ\text{C}$	60	A
E_{AR}	$T_C = 25^\circ\text{C}$	40	mJ
E_{AS}	$T_C = 25^\circ\text{C}$	1.0	J
dv/dt	$I_S \leq I_{DM}$, $di/dt \leq 100 \text{ A}/\mu\text{s}$, $V_{DD} \leq V_{DSS}$, $T_J \leq 175^\circ\text{C}$, $R_G = 4 \Omega$	10	V/ns
P_D	$T_C = 25^\circ\text{C}$	480	W
T_J		-55 ... +175	$^\circ\text{C}$
T_{JM}		175	$^\circ\text{C}$
T_{stg}		-55 ... +150	$^\circ\text{C}$
T_L	1.6 mm (0.062 in.) from case for 10 s Plastic body for 10s	300 250	$^\circ\text{C}$ $^\circ\text{C}$
F_C	Mounting force	11...65/2.4...11	N/lb
M_d	Mounting torque (TO-247)	1.13/10	Nm/lb.in.
Weight	TO-247	6	g
	PLUS220	4	g

TO-247 (IXFH)

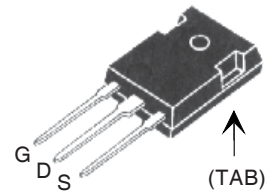

PLUS220 (IXFV)

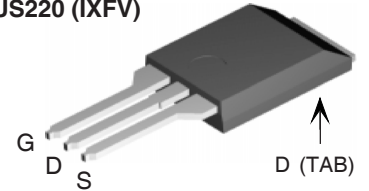

PLUS220SMD (IXFV__S)

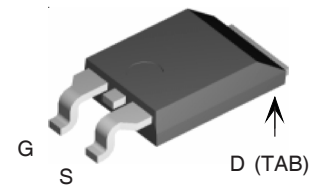

G = Gate D = Drain
S = Source TAB = Drain

Features

- International standard packages
- Unclamped Inductive Switching (UIS) rated
- Low package inductance
 - easy to drive and to protect

Advantages

- Easy to mount
- Space savings
- High power density

Symbol	Test Conditions ($T_J = 25^\circ\text{C}$, unless otherwise specified)	Characteristic Values		
		Min.	Typ.	Max.
V_{DSS}	$V_{GS} = 0 \text{ V}$, $I_D = 250 \mu\text{A}$	150		V
$V_{GS(th)}$	$V_{DS} = V_{GS}$, $I_D = 4 \text{ mA}$	3.0		5.0 V
I_{GSS}	$V_{GS} = \pm 20 \text{ V}_{DC}$, $V_{DS} = 0$			$\pm 100 \text{ nA}$
I_{DSS}	$V_{DS} = V_{DSS}$ $V_{GS} = 0 \text{ V}$ $T_J = 175^\circ\text{C}$			25 μA 1000 μA
$R_{DS(on)}$	$V_{GS} = 10 \text{ V}$, $I_D = 0.5 I_{D25}$ Pulse test, $t \leq 300 \mu\text{s}$, duty cycle $d \leq 2 \%$			24 $\text{m}\Omega$

Symbol	Test Conditions	Characteristic Values		
		$(T_J = 25^\circ\text{C}, \text{ unless otherwise specified})$		
		Min.	Typ.	Max.
g_{fs}	$V_{DS} = 10\text{ V}; I_D = 0.5 I_{D25}, \text{ pulse test}$	35	45	S
C_{iss}	$V_{GS} = 0\text{ V}, V_{DS} = 25\text{ V}, f = 1\text{ MHz}$		3500	pF
C_{oss}			1000	pF
C_{rss}			280	pF
$t_{d(on)}$	$V_{GS} = 10\text{ V}, V_{DS} = 0.5 V_{DSS}, I_D = 60\text{ A}$ $R_G = 4\ \Omega \text{ (External)}$		30	ns
t_r			33	ns
$t_{d(off)}$			66	ns
t_f			18	ns
$Q_{g(on)}$	$V_{GS} = 10\text{ V}, V_{DS} = 0.5 V_{DSS}, I_D = 0.5 I_{D25}$		110	nC
Q_{gs}			26	nC
Q_{gd}			59	nC
R_{thJC}	(TO-247, PLUS220)			0.31 K/W
R_{thCK}			0.21	K/W

Symbol	Test Conditions	Characteristic Values		
		$(T_J = 25^\circ\text{C}, \text{ unless otherwise specified})$		
		Min.	typ.	Max.
I_S	$V_{GS} = 0\text{ V}$			96 A
I_{SM}	Repetitive			250 A
V_{SD}	$I_F = I_S, V_{GS} = 0\text{ V},$ Pulse test, $t \leq 300\ \mu\text{s}, \text{ duty cycle } d \leq 2\%$			1.5 V
t_{rr}	$I_F = 25\text{ A}$ $-di/dt = 100\text{ A}/\mu\text{s}$ $V_R = 100\text{ V}$		100	200 ns
Q_{RM}			600	nC
I_{RM}			6	A

PLUS220SMD (IXFV_S) Outline

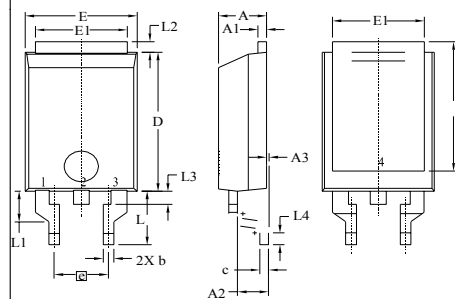

Terminals: 1 - Gate 2 - Drain
3 - Source TAB - Drain

SYM	INCHES		MILLIMETER	
	MIN	MAX	MIN	MAX
A	.169	.185	4.30	4.70
A1	.028	.035	0.70	0.90
A2	.098	.118	2.50	3.00
A3	.000	.010	0.00	0.25
b	.035	.047	0.90	1.20
c	.028	.035	0.70	0.90
D	.551	.591	14.00	15.00
D1	.512	.539	13.00	13.70
E	.394	.433	10.00	11.00
E1	.331	.346	8.40	8.80
e	.200BSC		5.08	BSC
L	.209	.228	5.30	5.80
L1	.118	.138	3.00	3.50
L2	.035	.051	0.90	1.30
L3	.047	.059	1.20	1.50
L4	.039	.059	1.00	1.50

TO-247 (IXFH) Outline

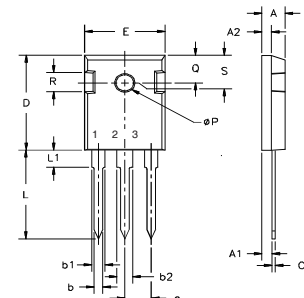

Terminals: 1 - Gate 2 - Drain
3 - Source TAB - Drain

Dim.	Millimeter		Inches	
	Min.	Max.	Min.	Max.
A	4.7	5.3	.185	.209
A ₁	2.2	2.54	.087	.102
A ₂	2.2	2.6	.059	.098
b	1.0	1.4	.040	.055
b ₁	1.65	2.13	.065	.084
b ₂	2.87	3.12	.113	.123
C	.4	.8	.016	.031
D	20.80	21.46	.819	.845
E	15.75	16.26	.610	.640
e	5.20	5.72	0.205	0.225
L	19.81	20.32	.780	.800
L ₁		4.50		.177
∅P	3.55	3.65	.140	.144
Q	5.89	6.40	0.232	0.252
R	4.32	5.49	.170	.216
S	6.15	BSC	.242	BSC

PLUS220 (IXFV) Outline

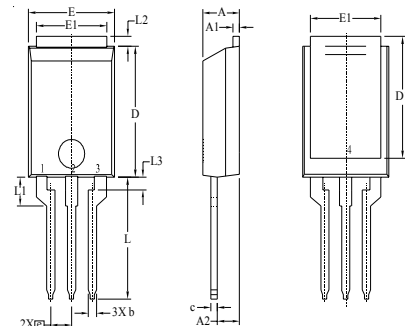

Terminals:
1 - Gate 2 - Drain
3 - Source TAB - Drain

SYM	INCHES		MILLIMETER	
	MIN	MAX	MIN	MAX
A	.169	.185	4.30	4.70
A1	.028	.035	0.70	0.90
A2	.098	.118	2.50	3.00
b	.035	.047	0.90	1.20
c	.028	.035	0.70	0.90
D	.551	.591	14.00	15.00
D1	.512	.539	13.00	13.70
E	.394	.433	10.00	11.00
E1	.331	.346	8.40	8.80
e	.100 BSC		2.54	BSC
L	.512	.551	13.00	14.00
L1	.118	.138	3.00	3.50
L2	.035	.051	0.90	1.30
L3	.047	.059	1.20	1.50

IXYS reserves the right to change limits, test conditions, and dimensions.

IXYS MOSFETs and IGBTs are covered by one or more of the following U.S. patents:	4,835,592	4,931,844	5,049,961	5,237,481	6,162,665	6,404,065B1	6,683,344	6,727,585
	4,850,072	5,017,508	5,063,307	5,381,025	6,259,123B1	6,534,343	6,710,405B2	6,710,463
	4,881,106	5,034,796	5,187,117	5,486,715	6,306,728 B1	6,583,505		

Fig. 1. Output Characteristics @ 25°C

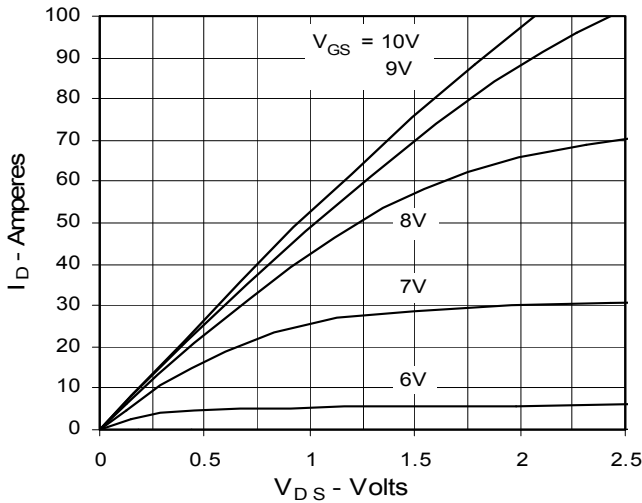

Fig. 2. Extended Output Characteristics @ 25°C

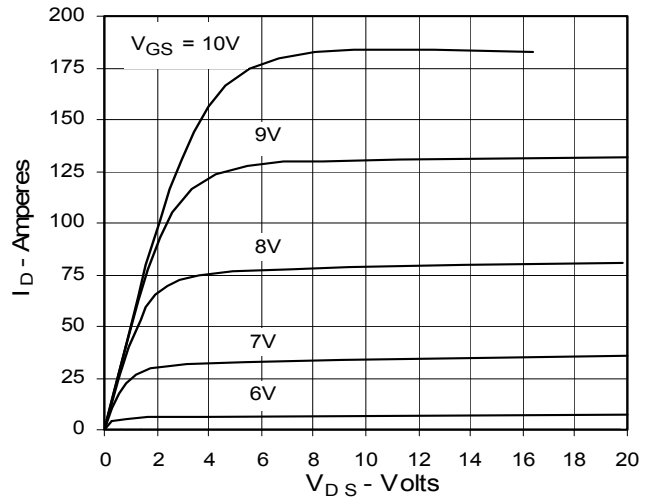

Fig. 3. Output Characteristics @ 150°C

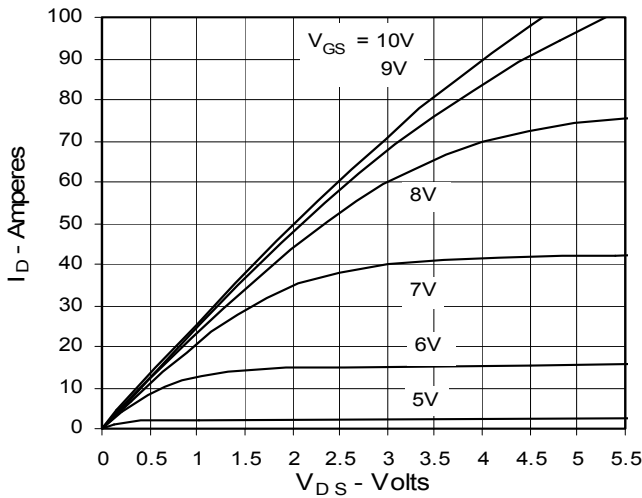

Fig. 4. $R_{DS(on)}$ Normalized to 0.5 I_{D25} Value vs. Junction Temperature

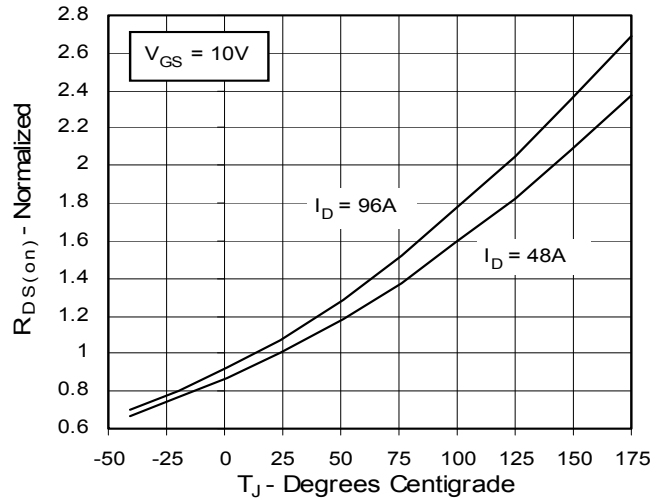

Fig. 5. $R_{DS(on)}$ Normalized to 0.5 I_{D25} Value vs. I_D

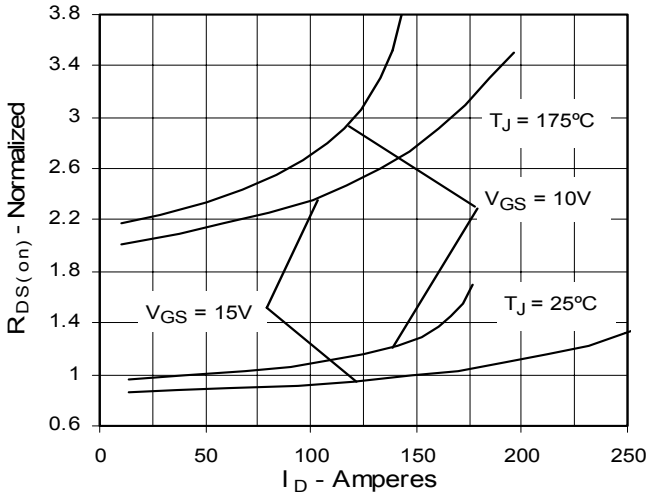

Fig. 6. Drain Current vs. Case Temperature

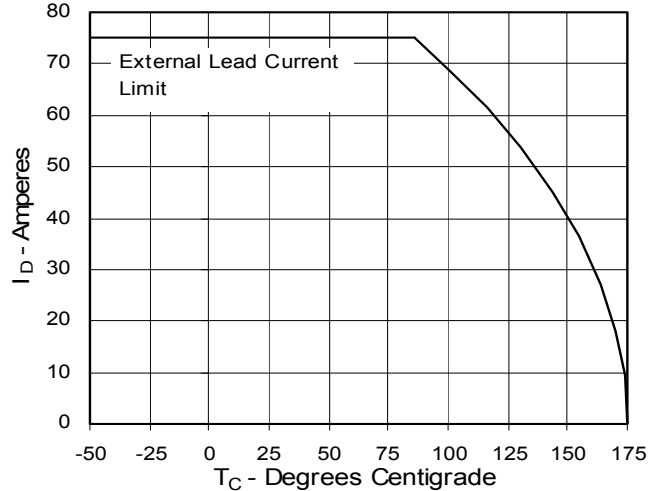

Fig. 7. Input Admittance

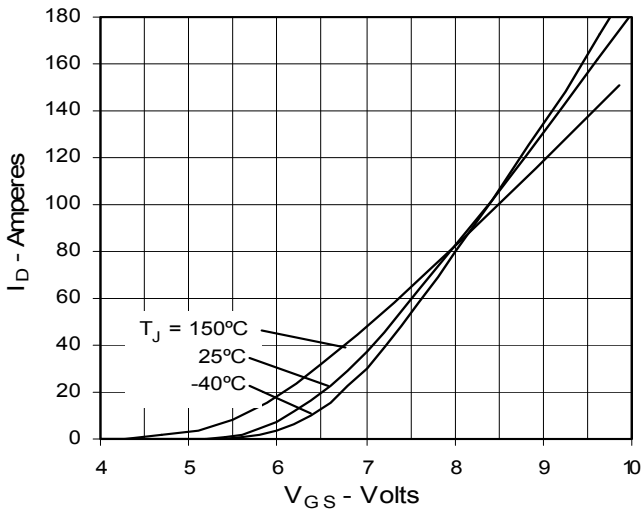

Fig. 8. Transconductance

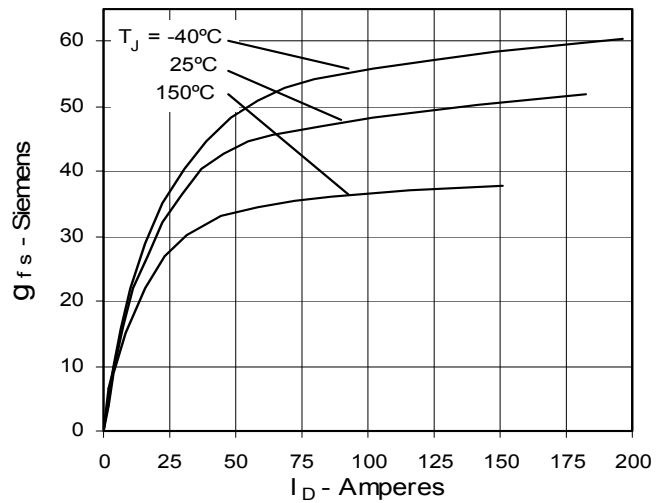

Fig. 9. Source Current vs. Source-To-Drain Voltage

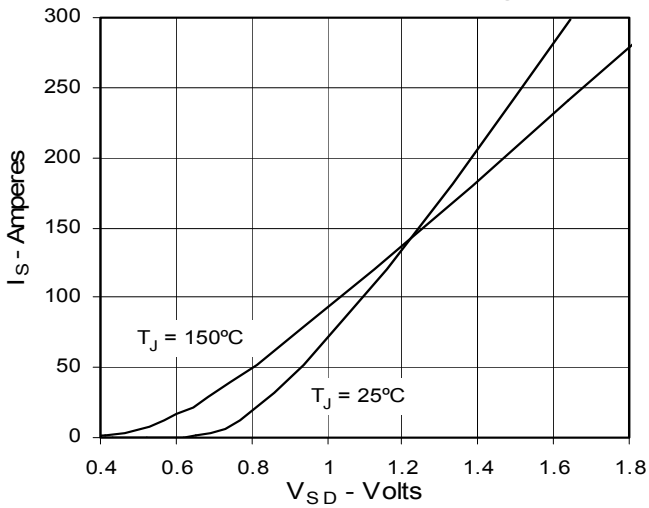

Fig. 10. Gate Charge

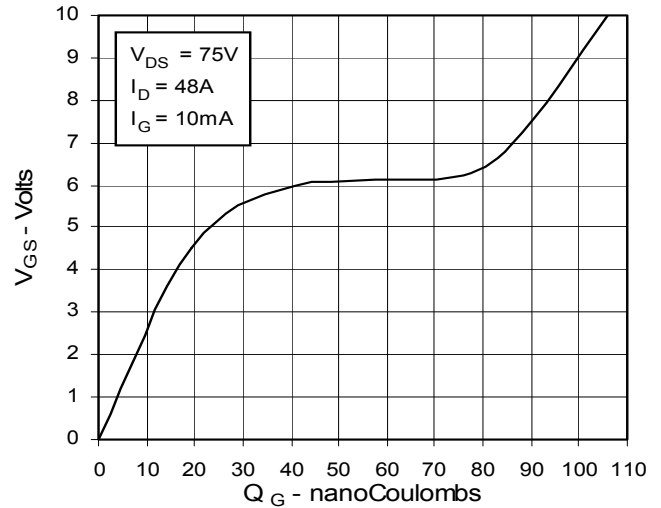

Fig. 11. Capacitance

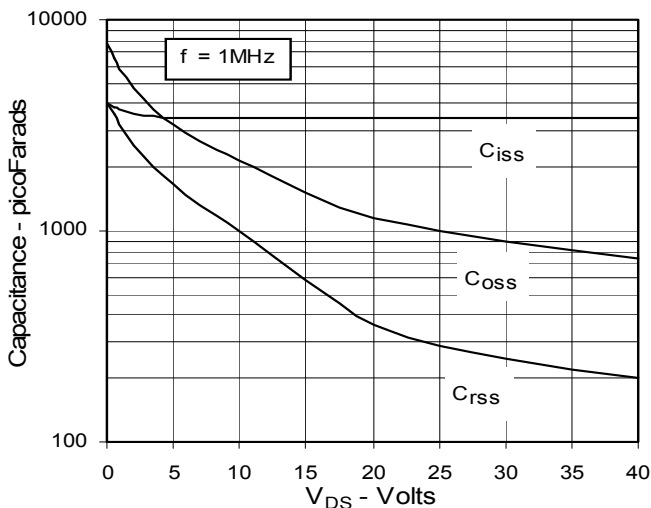

Fig. 12. Forward-Bias Safe Operating Area

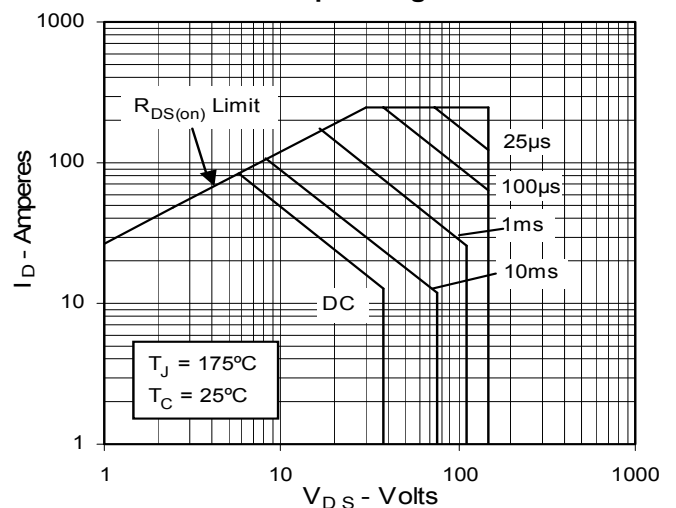

Fig. 13. Maximum Transient Thermal Resistance

