

MAXIM

Low-Power, Low-Drift, +2.5V/+5V/+10V Precision Voltage References

General Description

The MAX873/MAX875/MAX876 precision 2.5V, 5V, and 10V references offer excellent accuracy and very low power consumption. Extremely low temperature drift combined with excellent line and load regulation permit stable operation over a wide range of electrical and environmental conditions. Operation for the MAX873 is guaranteed with a +4.5V supply, making the part ideal in systems running from a +5V $\pm 10\%$ supply. Low 10Hz to 1kHz noise—typically 15 μ V_{RMS}, 30 μ V_{RMS}, and 60 μ V_{RMS}, respectively, for the MAX873, MAX875, and MAX876—make the parts suitable for 12-bit data-acquisition systems.

A TRIM pin facilitates adjustment of the reference voltage over a 4% range, using only a 100k Ω potentiometer. A voltage output proportional to temperature provides a source for temperature compensation circuits, temperature warning circuits, and other applications.

Applications

12-Bit A/D and D/A Converters
Digital Multimeters
Portable Data-Acquisition Systems
Low-Power Test Equipment

Pin Configuration

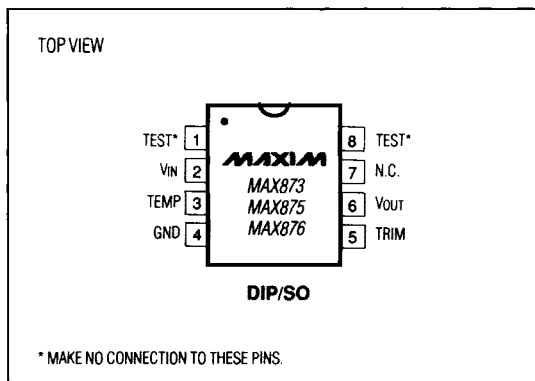

Features

- ◆ MAX873/MAX875/MAX876
+2.5V/+5V/+10V Outputs
 $\pm 1.5\text{mV}/\pm 2.0\text{mV}/\pm 3.0\text{mV}$ Max Initial Accuracy
 $\pm 2.5\text{mV}/\pm 4\text{mV}/\pm 7\text{mV}$ Max Error Over Temperature
- ◆ 7ppm/°C (Max) Temperature Coefficient
- ◆ 280 μ A (Max) Quiescent Current
- ◆ Sources 10mA, Sinks 2mA
- ◆ 15ppm/mA Load Regulation (Max)
- ◆ 4ppm/V Line Regulation (Max)
- ◆ Wide Supply Voltage Range, +4.5V to +18V (MAX873)
- ◆ TEMP Output Proportional to Temperature

Ordering Information

PART	PIN-PACKAGE	TEMPCO (ppm/°C max)	V _{OUT} AT +25°C
TEMP. RANGE 0°C to +70°C			
MAX873ACPA	8 Plastic DIP	7	2.5V $\pm 1.5\text{mV}$
MAX873BCPA	8 Plastic DIP	20	2.5V $\pm 2.5\text{mV}$
MAX873ACSA	8 SO	7	2.5V $\pm 1.5\text{mV}$
MAX873BCSA	8 SO	20	2.5V $\pm 2.5\text{mV}$
MAX873BC/D	Dice*	20	2.5V $\pm 2.5\text{mV}$

Ordering Information continued on last page.

* Dice are tested at $T_A = +25^\circ\text{C}$ only.

Typical Operating Circuit

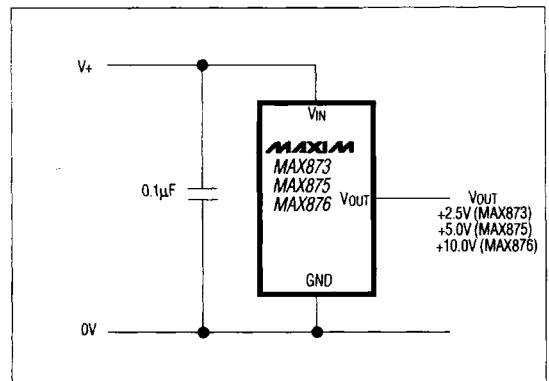

MAX873/MAX875/MAX876

6

Low-Power, Low-Drift, +2.5V /+5V/+10V Precision Voltage References

ABSOLUTE MAXIMUM RATINGS

V _{CC} to GND20V
V _{OUT} , TRIM, TEMP, TEST (GND - 0.3V) to (V _{CC} + 0.3V)	
Output Short-Circuit Duration (to GND)	Continuous
Current into Any Pin	±50mA
Continuous Power Dissipation (T _A = +70°C)		
Plastic DIP (derate 9.09mW/°C above +70°C)727mW
SO (derate 5.88mW/°C above +70°C)471mW
CERDIP (derate 8.00mW/°C above +70°C)640mW

Operating Temperature Ranges:

MAX87__C_A	0°C to +70°C
MAX87__E_A	-40°C to +85°C
MAX87__MJA	-55°C to +125°C
Storage Temperature Range	-65°C to +150°C
Lead Temperature (soldering, 10 sec)	+300°C

Stresses beyond those listed under "Absolute Maximum Ratings" may cause permanent damage to the device. These are stress ratings only, and functional operation of the device at these or any other conditions beyond those indicated in the operational sections of the specifications is not implied. Exposure to absolute maximum rating conditions for extended periods may affect device reliability.

ELECTRICAL CHARACTERISTICS – MAX873

(V_{IN} = +5V, I_L = 0mA, C_{LOAD} < 100pF, T_A = T_{MIN} to T_{MAX}, unless otherwise noted.)

PARAMETER	SYMBOL	CONDITIONS		MIN	TYP	MAX	UNITS
Output Voltage	V _{OUT}	T _A = +25°C	MAX873A	2.4985	2.5000	2.5015	V
			MAX873B	2.4975	2.5000	2.5025	
		0°C ≤ T _A ≤ +70°C	MAX873A	2.4975	2.5000	2.5025	
			MAX873B	2.4950	2.5000	2.5050	
		-40°C ≤ T _A ≤ +85°C	MAX873A	2.4970	2.5000	2.5030	
			MAX873B	2.4940	2.5000	2.5060	
		-55°C ≤ T _A ≤ +125°C	MAX873A	2.4960	2.5000	2.5040	
			MAX873B	2.4925	2.5000	2.5075	
Output-Voltage Drift	TCV _{OUT}	(Note 1)	MAX873A		4	7	ppm/°C
			MAX873B		10	20	
Output-Noise Voltage	e _n	T _A = +25°C	0.1Hz to 10Hz		16		μV _{p-p}
			10Hz to 1kHz		15		μV _{RMS}
Line Regulation		V _{IN} = 4.5V to 18V	T _A = +25°C		1.5	4.0	ppm/V
		MAX873_C/E: V _{IN} = 4.5V to 18V	T _A = T _{MIN} to T _{MAX}		3	6	
		MAX873_MJA: V _{IN} = 4.75V to 18V					
Load Regulation		I _L = 0mA to 10mA (source)	T _A = +25°C		6	15	ppm/mA
			T _A = T _{MIN} to T _{MAX}		10	20	
		I _L = 0mA to -2mA (sink)	T _A = +25°C		6	15	
			T _A = T _{MIN} to T _{MAX}		10	20	
Quiescent Supply Current	I _Q		T _A = +25°C		190	280	μA
			T _A = T _{MIN} to T _{MAX}		190	375	
Short-Circuit Output Current	I _{SC}	Output shorted to GND			35		mA
V _{OUT} Adjust Range					±95		mV
Long-Term Output Drift					20		ppm/kh
TEMP PIN							
Voltage Output	V _{TEMP}		T _A = +25°C		608		mV
Temperature Sensitivity	TCV _{TEMP}				2		mV/°C

Low-Power, Low-Drift, +2.5V/+5V/+10V Precision Voltage References

ELECTRICAL CHARACTERISTICS – MAX875

(VIN = +15V, IL = 0mA, CLOAD < 100pF, TA = TMIN to TMAX, unless otherwise noted.)

PARAMETER	SYMBOL	CONDITIONS		MIN	TYP	MAX	UNITS	
Output Voltage	VOUT		TA = +25°C	MAX875A	4.998	5.000	5.002	V
			MAX875B	4.997	5.000	5.003		
		0°C ≤ TA ≤ +70°C	MAX875A	4.996	5.000	5.004		
			MAX875B	4.992	5.000	5.008		
		-40°C ≤ TA ≤ +85°C	MAX875A	4.9945	5.000	5.0055		
			MAX875B	4.990	5.000	5.010		
		-55°C ≤ TA ≤ +125°C	MAX875A	4.9935	5.000	5.0065		
			MAX875B	4.988	5.000	5.012		
Output-Voltage Drift	TCVOUT	(Note 1)		MAX875A	4	7	ppm/°C	
			MAX875B	10	20			
Output-Noise Voltage	en		TA = +25°C	0.1Hz to 10Hz	32		μVp-p	
				10Hz to 1kHz	30		μVRMS	
Line Regulation		VIN = 7V to 18V	TA = +25°C		1.5	4.0	ppm/V	
		MAX875_C/E: VIN = 7V to 18V	TA = TMIN to TMAX		3	6		
		MAX875_MJA: VIN = 7.2V to 18V						
Load Regulation		IL = 0mA to 10mA (source)	TA = +25°C		6	15	ppm/mA	
			TA = TMIN to TMAX		10	20		
		IL = 0mA to -2mA (sink)	TA = +25°C		6	15		
			TA = TMIN to TMAX		10	20		
Quiescent Supply Current	IQ		TA = +25°C		190	280	μA	
			TA = TMIN to TMAX		190	375		
Short-Circuit Output Current	ISC	Output shorted to GND			35		mA	
VOUT Adjust Range					±200		mV	
Long-Term Output Drift					20		ppm/kh	
TEMP PIN								
Voltage Output	VTEMP		TA = +25°C		608		mV	
Temperature Sensitivity	TCVTEMP				2		mV/°C	

MAX873/MAX875/MAX876

6

Low-Power, Low-Drift, +2.5V /+5V/+10V Precision Voltage References

ELECTRICAL CHARACTERISTICS – MAX876

(VIN = +15V, IL = 0mA, CLOAD < 100pF, TA = TMIN to TMAX, unless otherwise noted.)

PARAMETER	SYMBOL	CONDITIONS		MIN	TYP	MAX	UNITS		
Output Voltage	VOUT		TA = +25°C	MAX876A	9.997	10.000	10.003	V	
				MAX876B	9.995	10.000	10.005		
		0°C ≤ TA ≤ +70°C	MAX876A	9.993	10.000	10.007			
			MAX876B	9.985	10.000	10.015			
		-40°C ≤ TA ≤ +85°C	MAX876A	9.990	10.000	10.010			
			MAX876B	9.975	10.000	10.025			
		-55°C ≤ TA ≤ +125°C	MAX876A	9.990	10.000	10.010			
			MAX876B	9.975	10.000	10.025			
Output-Voltage Drift	TCVOUT	(Note 1)		MAX876A	4	7	ppm/°C		
				MAX876B	10	20			
Output-Noise Voltage	en		TA = +25°C	0.1Hz to 10Hz	64		μVp-p		
				10Hz to 1kHz	60		μVRMS		
Line Regulation		VIN = 12V to 18V	TA = +25°C			1.5	4.0	ppm/V	
		MAX876_C/E: VIN = 12V to 18V		TA = TMIN to TMAX			3		6
		MAX876_MJA: VIN = 12.2V to 18V							
Load Regulation		IL = 0mA to 10mA (source)	TA = +25°C			6	15	ppm/mA	
			TA = TMIN to TMAX			10	20		
		IL = 0mA to -2mA (sink)	TA = +25°C			6	15		
			TA = TMIN to TMAX			10	20		
Quiescent Supply Current	IQ		TA = +25°C			190	280	μA	
			TA = TMIN to TMAX			190	375		
Short-Circuit Output Current	ISC	Output shorted to GND			35		mA		
VOUT Adjust Range					±400		mV		
Long-Term Output Drift					20		ppm/kh		
TEMP PIN									
Voltage Output	VTEMP		TA = +25°C			608	mV		
Temperature Sensitivity	TCVTEMP				2		mV/°C		

Note 1: Temperature coefficient is determined by the "box" method in which the maximum ΔVOUT over the temperature range is divided by ΔT.

Low-Power, Low-Drift, +2.5V/+5V/+10V Precision Voltage References

Typical Operating Characteristics

$T_A = +25^\circ\text{C}$, $V_{IN} = +5\text{V}$ (MAX873), $V_{IN} = +15\text{V}$ (MAX875/MAX876), $I_L = 0\text{mA}$, $C_{LOAD} < 100\text{pF}$, unless otherwise noted.)

TEMP PIN VOLTAGE vs. TEMPERATURE

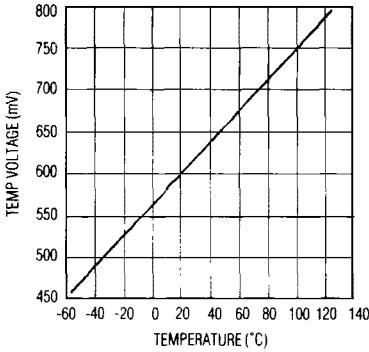

POWER-SUPPLY REJECTION RATIO vs. FREQUENCY

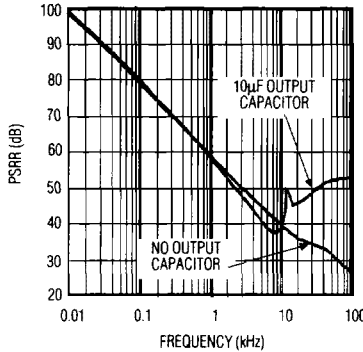

SUPPLY CURRENT vs. TEMPERATURE

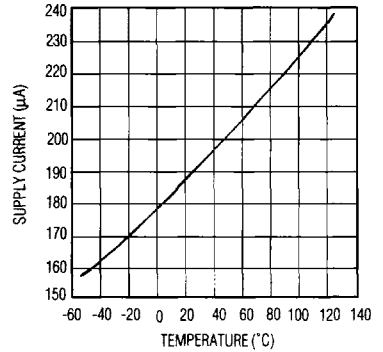

MAX873 WIDEBAND OUTPUT NOISE vs. BANDWIDTH

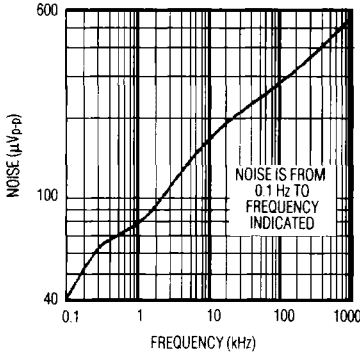

MAX875 WIDEBAND OUTPUT NOISE vs. BANDWIDTH

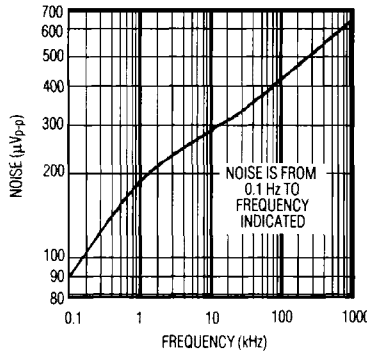

MAX876 WIDEBAND OUTPUT NOISE vs. BANDWIDTH

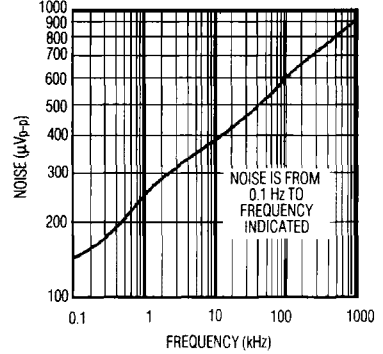

MAX873 OUTPUT VOLTAGE vs. TEMPERATURE

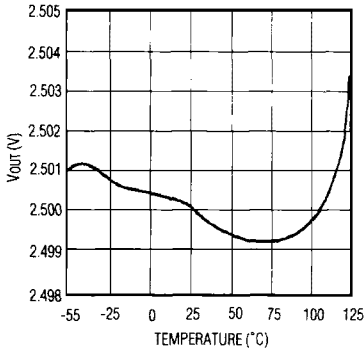

MAX875 OUTPUT VOLTAGE vs. TEMPERATURE

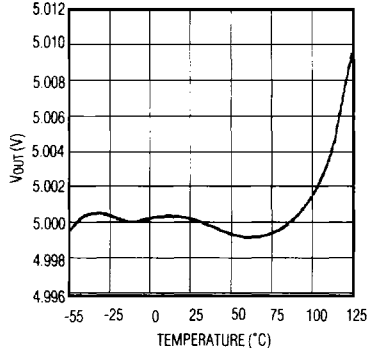

MAX876 OUTPUT VOLTAGE vs. TEMPERATURE

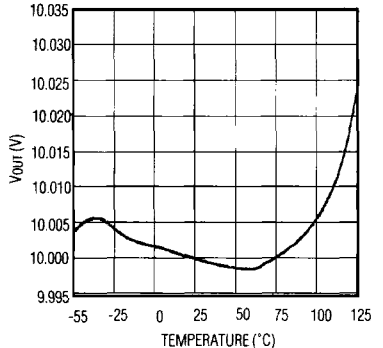

MAX873/MAX875/MAX876

6

Low-Power, Low-Drift, +2.5V /+5V/+10V Precision Voltage References

Pin Description

PIN	NAME	FUNCTION
1,8	TEST	For factory test use only. Make no connections to these pins.
2	V _{IN}	Supply Voltage
3	TEMP	Temperature Proportional Output Voltage. Generates a voltage proportional to the temperature of the die.
4	GND	Ground
5	TRIM	Output Voltage Trim. Connect to the center of a voltage divider for trimming; otherwise, make no connection.
6	V _{OUT}	Output Voltage
7	N.C.	No Connect - not internally connected.

Detailed Description

The bipolar MAX873, MAX875, and MAX876 are bandgap references, amplified to give an output voltage of 2.500V, 5.000V, and 10.000V, respectively. Laser trimming is used to adjust the output voltage and minimize thermal drift. Post-package trimming allows control of the output to within $\pm 1.5\text{mV}$, $\pm 2.0\text{mV}$, and $\pm 3.0\text{mV}$, respectively.

The MAX873, MAX875, and MAX876 are essentially three-terminal references with a power-supply input, ground, and reference output. Additionally, a TRIM pin facilitates adjustment of the reference voltage over a 4% range using only a 100k Ω potentiometer. A voltage output proportional to temperature provides a source for temperature compensation circuits, temperature warning circuits, and other applications.

Applications Information

Input Bypassing

For best transient performance, decouple the input with a 10 μF electrolytic capacitor in parallel with a 0.01 μF to 0.1 μF ceramic capacitor as shown in Figure 1. Where transient performance is less important, a single 0.1 μF capacitor is sufficient.

Output Bypassing

These devices perform well with no output decoupling capacitance. However, if the capacitive load on the output exceeds 100pF, bypass the output with at least 1 μF to ensure stability. A 10 μF electrolytic capacitor in parallel with a 0.01 μF to 0.1 μF ceramic capacitor provides excellent load-transient performance and guarantees stability as shown in Figure 1.

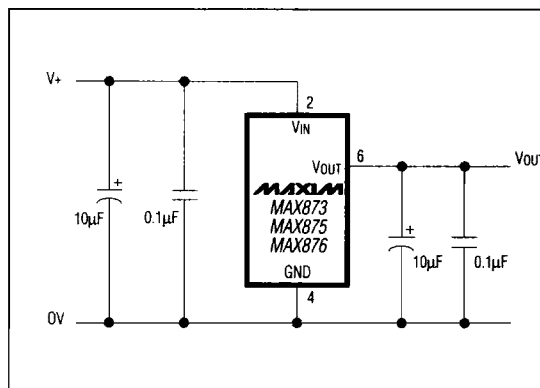

Figure 1. Recommended Bypassing for Good High-Frequency Response

Standard Application

The standard application for the references is shown in the *Typical Operating Circuit*. Additional bypassing, shown in Figure 1, provides superior performance over a range of conditions.

Output-Voltage Trimming

Use a 100k Ω potentiometer as shown in Figure 2 to trim the output voltage to the desired level. A trim range of $\pm 95\text{mV}$ (MAX873), $\pm 200\text{mV}$ (MAX875), or $\pm 400\text{mV}$ (MAX876) is available using this technique. Large adjustments of the output voltage may degrade its temperature coefficient by as much as 5ppm/ $^{\circ}\text{C}$.

Low-Power, Low-Drift, +2.5V/+5V/+10V Precision Voltage References

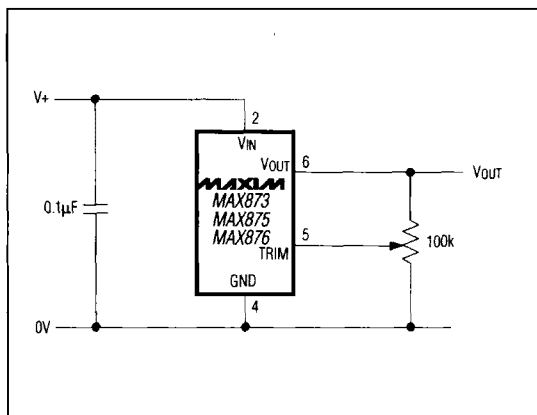

Figure 2. Output-Voltage Trim Circuit

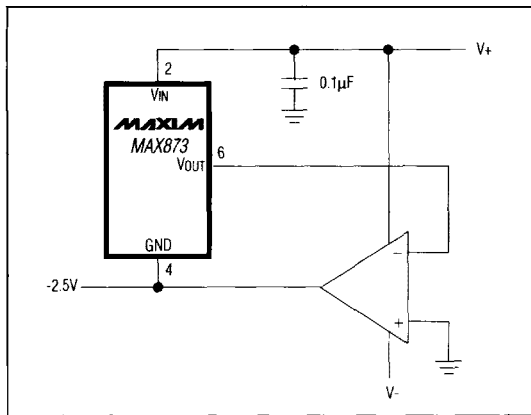

Figure 4. Low-Dropout -2.5V Reference

Inverting Applications

+2.5V and -2.5V reference voltages can be generated using the MAX873 with an op amp in the traditional gain of -1 configuration shown in Figure 3. The accuracy of this circuit depends on the matching of the two resistors R and R'. A similar configuration using the MAX875 and MAX876 can provide ±5V and ±10V references, respectively.

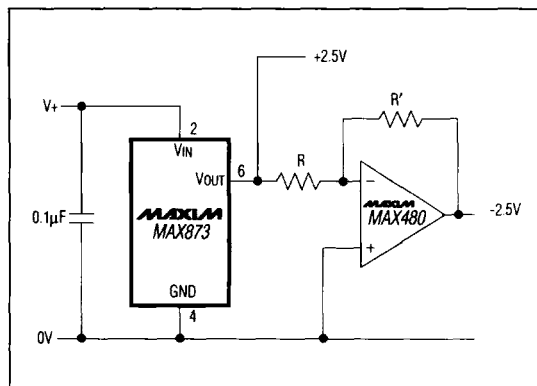

Figure 3. +2.5V and -2.5V Outputs

The circuit in Figure 4 requires no resistors and suffers only from offset and temperature coefficient errors of the op amp itself. The op amp also buffers the reference, so the output capability of this circuit depends on the performance of the op amp selected. In addition, the dropout performance of this circuit is very good: the positive rail can go down to about 1.5V because the MAX873 is unloaded, and the negative rail can decline typically to -3.2V using a MAX480, or to -2.6V using an ICL7611 (I_Q = 100µA mode). A similar configuration using the MAX875 or MAX876 can generate -5.0V or -10.0V references, respectively.

Temperature Measurement

The TEMP output delivers a voltage proportional to the absolute temperature of the die. In packaged parts, this closely approximates the ambient temperature of the device because the power dissipation of the reference itself is very small. The temperature coefficient of this output is typically 2mV/°C, and the nominal voltage at +25°C is 608mV (*Typical Operating Characteristics*).

Low-Power, Low-Drift, +2.5V /+5V/+10V Precision Voltage References

MAX873/MAX875/MAX876

Ordering Information (continued)

PART	PIN-PACKAGE	TEMPCO (ppm/°C max)	V _{OUT} AT +25°C
TEMP. RANGE -40°C TO +85°C			
MAX873AEPA	8 Plastic DIP	7	2.5V ±1.5mV
MAX873BEPA	8 Plastic DIP	20	2.5V ±2.5mV
MAX873AEESA	8 SO	7	2.5V ±1.5mV
MAX873BEESA	8 SO	20	2.5V ±2.5mV
TEMP. RANGE -55°C TO +125°C			
MAX873AMJA	8 CERDIP**	7	2.5V ±1.5mV
MAX873BMJA	8 CERDIP**	20	2.5V ±2.5mV
TEMP. RANGE 0°C to +70°C			
MAX875ACPA	8 Plastic DIP	7	5V ±2.0mV
MAX875BCPA	8 Plastic DIP	20	5V ±3.0mV
MAX875ACSA	8 SO	7	5V ±2.0mV
MAX875BCSA	8 SO	20	5V ±3.0mV
MAX875BC/D	Dice*	20	5V ±3.0mV
TEMP. RANGE -40°C TO +85°C			
MAX875AEPA	8 Plastic DIP	7	5V ±2.0mV
MAX875BEPA	8 Plastic DIP	20	5V ±3.0mV
MAX875AEESA	8 SO	7	5V ±2.0mV
MAX875BEESA	8 SO	20	5V ±3.0mV
TEMP. RANGE -55°C TO +125°C			
MAX875AMJA	8 CERDIP**	7	5V ±2.0mV
MAX875BMJA	8 CERDIP**	20	5V ±3.0mV
TEMP. RANGE 0°C to +70°C			
MAX876ACPA	8 Plastic DIP	7	10V ±3.0mV
MAX876BCPA	8 Plastic DIP	20	10V ±5.0mV
MAX876ACSA	8 SO	7	10V ±3.0mV
MAX876BCSA	8 SO	20	10V ±5.0mV
MAX876BC/D	Dice*	20	10V ±5.0mV

PART	PIN-PACKAGE	TEMPCO (ppm/°C max)	V _{OUT} AT +25°C
TEMP. RANGE -40°C TO +85°C			
MAX876AEPA	8 Plastic DIP	7	10V ±3.0mV
MAX876BEPA	8 Plastic DIP	20	10V ±5.0mV
MAX876AEESA	8 SO	7	10V ±3.0mV
MAX876BEESA	8 SO	20	10V ±5.0mV
TEMP. RANGE -55°C TO +125°C			
MAX876AMJA	8 CERDIP**	7	10V ±3.0mV
MAX876BMJA	8 CERDIP**	20	10V ±5.0mV

* Dice are tested at T_A = +25°C only.

** Contact factory for availability and processing to MIL-STD-883.

Chip Topography

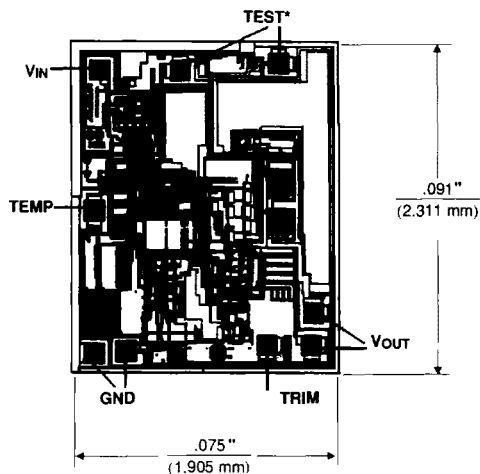

SUBSTRATE CONNECTED TO GND;
TRANSISTOR COUNT: 76.

* MAKE NO CONNECTION TO THESE PADS