

> Features

- High Speed Switching
- Low On-Resistance
- No Secondary Breakdown
- Low Driving Power
- High Voltage
- VGS = ± 30V Guarantee
- Repetitive Avalanche Rated

> Applications

- Switching Regulators
- UPS
- DC-DC converters
- General Purpose Power Amplifier

> Outline Drawing

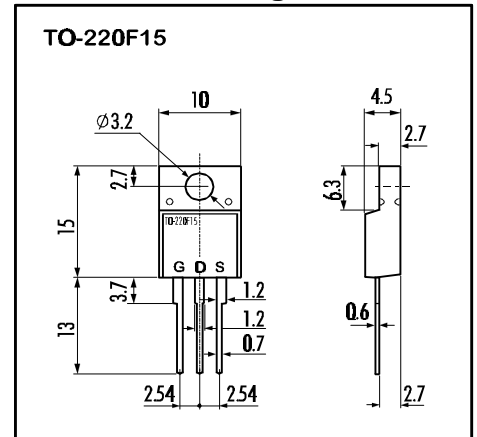

> Maximum Ratings and Characteristics

- Absolute Maximum Ratings (T_C=25°C), unless otherwise specified

Item	Symbol	Rating	Unit
Drain-Source-Voltage	V _{DS}	800	V
Continous Drain Current	I _D	4	A
Pulsed Drain Current	I _{D(puls)}	16	A
Gate-Source-Voltage	V _{GS}	±30	V
Repetitive or Non-Repetitive (T _{ch} ≤ 150°C)	I _{AR}	4	A
Avalanche Energy	E _{AS}	109	mJ
Max. Power Dissipation	P _D	40	W
Operating and Storage Temperature Range	T _{ch}	150	°C
	T _{stg}	-55 ~ +150	°C

> Equivalent Circuit

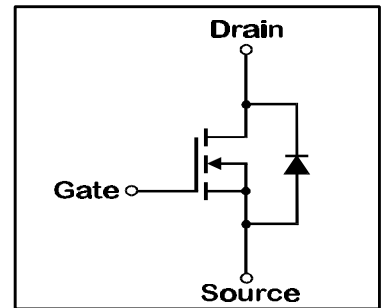

- Electrical Characteristics (T_C=25°C), unless otherwise specified

Item	Symbol	Test conditions	Min.	Typ.	Max.	Unit
Drain-Source Breakdown-Voltage	V _{(BR)DSS}	I _D =1mA V _{GS} =0V	800			V
Gate Threshold Voltage	V _{GS(th)}	I _D =1mA V _{DS} =V _{GS}	3,5	4,0	4,5	V
Zero Gate Voltage Drain Current	I _{DSS}	V _{DS} =800V T _{ch} =25°C		10	500	μA
		V _{GS} =0V T _{ch} =125°C		0,2	1,0	mA
Gate Source Leakage Current	I _{GSS}	V _{GS} =±30V V _{DS} =0V		10	100	nA
Drain Source On-State Resistance	R _{DS(on)}	I _D =2A V _{GS} =10V		3,19	4,0	Ω
Forward Transconductance	g _{fs}	I _D =2A V _{DS} =25V		2		S
Input Capacitance	C _{iss}	V _{DS} =25V		450		pF
Output Capacitance	C _{oss}	V _{GS} =0V		75		pF
Reverse Transfer Capacitance	C _{rss}	f=1MHz		40		pF
Turn-On-Time t _{on} (t _{on} =t _{d(on)} +t _r)	t _{d(on)}	V _{CC} =600V		20		ns
	t _r	I _D =4A		40		ns
Turn-Off-Time t _{off} (t _{off} =t _{d(off)} +t _f)	t _{d(off)}	V _{GS} =10V		50		ns
	t _f	R _{GS} =10 Ω		25		ns
Avalanche Capability	I _{AV}	L = 100μH T _{ch} =25°C	3			A
Diode Forward On-Voltage	V _{SD}	I _F =2I _{DR} V _{GS} =0V T _{ch} =25°C		1,0		V
Reverse Recovery Time	t _{rr}	I _F =I _{DR} V _{GS} =0V		450		ns
Reverse Recovery Charge	Q _{rr}	-di _F /dt=100A/μs T _{ch} =25°C		3,0		μC

- Thermal Characteristics

Item	Symbol	Test conditions	Min.	Typ.	Max.	Unit
Thermal Resistance	R _{th(ch-a)}	channel to air			62,5	°C/W
	R _{th(ch-c)}	channel to case			3,125	°C/W

N-channel MOS-FET			
800V	4Ω	4A	40W

2SK2647-01MR

FAP-IIS Series



> Characteristics

Typical Output Characteristics

$I_D=f(V_{DS})$; 80μs pulse test; $T_C=25^\circ\text{C}$

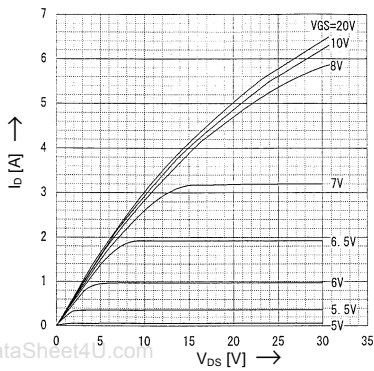

Drain-Source-On-State Resistance vs. T_{ch}

$R_{DS(on)}=f(T_{ch})$; $I_D=2\text{A}$; $V_{GS}=10\text{V}$

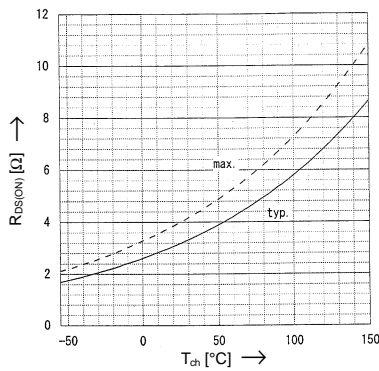

Typical Transfer Characteristics

$I_D=f(V_{GS})$; 80μs pulse test; $V_{DS}=25\text{V}$; $T_{ch}=25^\circ\text{C}$

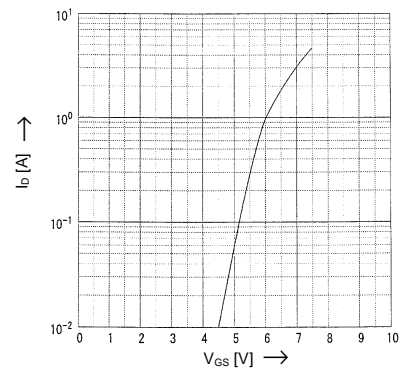

Typical Drain-Source-On-State-Resistance vs. I_D

$R_{DS(on)}=f(I_D)$; 80μs pulse test; $T_C=25^\circ\text{C}$

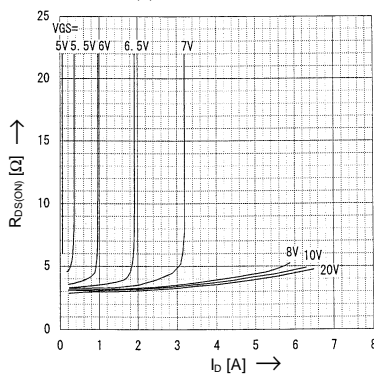

Typical Forward Transconductance vs. I_D

$g_{fs}=f(I_D)$; 80μs pulse test; $V_{DS}=25\text{V}$; $T_{ch}=25^\circ\text{C}$

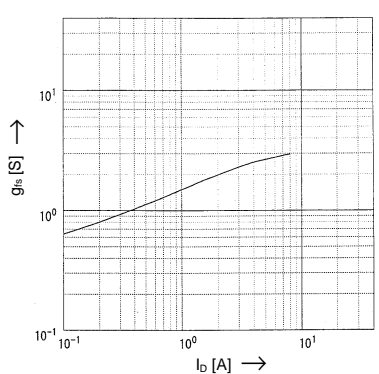

Gate Threshold Voltage vs. T_{ch}

$V_{GS(th)}=f(T_{ch})$; $I_D=1\text{mA}$; $V_{DS}=V_{GS}$

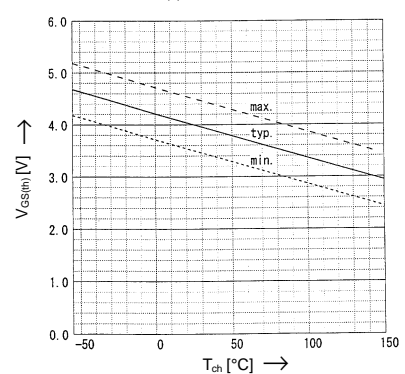

Typical Capacitances vs. V_{DS}

$C=f(V_{DS})$; $V_{GS}=0\text{V}$; $f=1\text{MHz}$

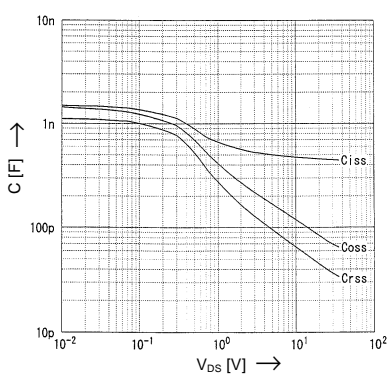

Avalanche Energy Derating

$E_{as}=f(\text{starting } T_{ch})$; $V_{CC}=80\text{V}$; $I_{AV}=4\text{A}$

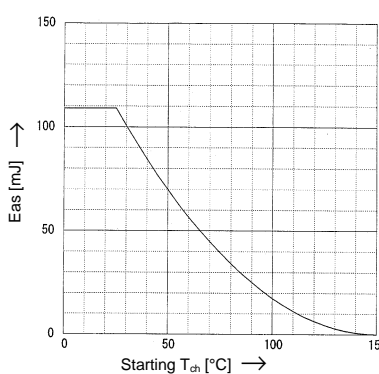

Forward Characteristics of Reverse Diode

$I_F=f(V_{SD})$; 80μs pulse test; $V_{GS}=0\text{V}$

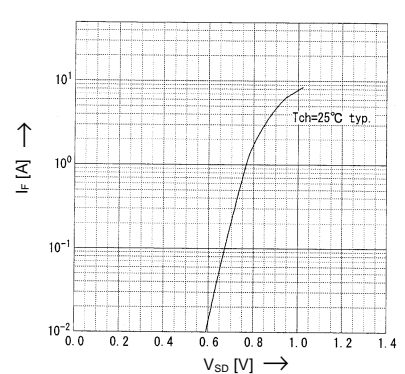

Allowable Power Dissipation vs. T_C

$P_D=f(T_C)$

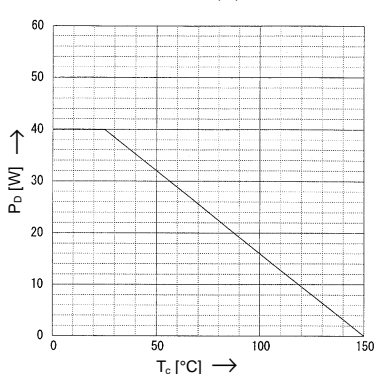

Safe operation area

$I_D=f(V_{DS})$; $D=0.01$; $T_C=25^\circ\text{C}$

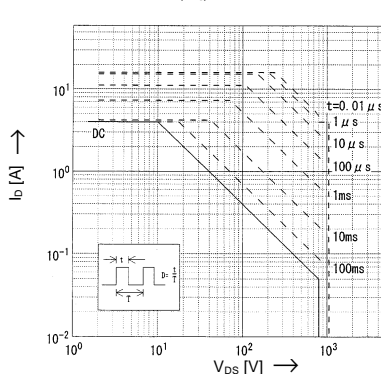

Transient Thermal impedance

$Z_{th(ch-c)}=f(t)$ parameter: $D=t/T$

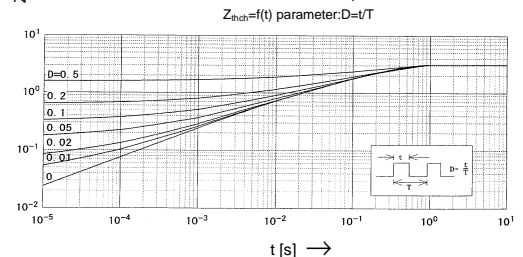

This specification is subject to change without notice!