

CCD area image sensor S7199-01



Front-illuminated FFT-CCDs for X-ray imaging

S7199-01 is a family of FFT-CCD image sensors specifically designed for X-ray imaging. A FOS (Fiber Optic plate with Scintillator) that converts X-ray into visible-light is mounted on the CCD chip, which enables S7199-01 to acquire the X-ray imaging. Two CCD chips of symmetric from side to side are mounted closely for realizing the possible minimum dead space in between. The effective photosensitive length of about 150 mm in total is realized; each chip has 1536 × 128 pixels and the pixel size is 48 × 48 μm. Even a X-ray image of moving object can be taken by taking a unique operation method of TDI, which can also be useful for a non-destructive inspection where the object moves on a belt conveyor.

The each chip of S7199-01 has an effective pixel size of 48 × 48 μm and is available in active area of 73.728 (H) × 6.144 (V) mm². FOP type is also available (S7199-01F).

Features

- 1536 (H) × 128 (V) pixel format
- Pixel size: 48 × 48 μm
- Buttable structure of 2 chips
- Coupled with FOS for X-ray imaging
- TDI (Time Delay Integration) operation
- 100 % fill factor
- Wide dynamic range
- Low dark signal
- Low readout noise
- MPP operation

Applications

- General X-ray imaging
- Non-destructive inspection
- Dental panorama

■ Selection guide

Type No.	Window	Cooling	Number of total pixels	Number of active pixels	Active area [mm (H) × mm(V)]
S7199-01	FOS (fiber optic plate with scintillator)	Non-cooled	1536 × 128	1536 × 128	73.728 × 6.144
S7199-01F*	FOP (fiber optic plate)				

Note) As an input window, FOS is suited to S7199-01.

* When this product is used for X-ray detection applications, the user should assemble a scintillator or phosphor sheet.

■ General ratings

Parameter	S7199-01	S7199-01F
CCD structure	Full frame transfer or TDI	
Fill factor	100 %	
Number of active pixels	1536 (H) × 128 (V) *1	
Pixel size	48 (H) × 48 (V) μm	
CCD active area	73.728 (H) × 6.144 (V) mm *1	
X-ray sensitive area	146 × 6 mm	
Vertical clock phase	2 phase	
Horizontal clock phase	2 phase	
Output circuit	Two-stage MOSFET source follower with load resistance	
X-ray resolution	4 to 6 Lp/mm at 60 kVp, 20 μGy	-
Total dose irradiation	50 Gy max.	
Package	40 pin ceramic package	

*1: Number of active pixels per chip. Two chips are used.

■ Absolute maximum ratings (Ta=25 °C)

Parameter	Symbol	Min.	Typ.	Max.	Unit
Storage temperature	Tstg	-20	-	+70	°C
Operating temperature	Topr	0	-	+40	°C
OD voltage	VOD	-0.5	-	+20	V
RD voltage	VRD	-0.5	-	+18	V
ISV voltage	VISV	-0.5	-	+18	V
IGV voltage	VIGV	-15	-	+15	V
IGH voltage	VIGH	-15	-	+15	V
SG voltage	VSG	-15	-	+15	V
OG voltage	VOG	-15	-	+15	V
RG voltage	VRG	-15	-	+15	V
TG voltage	VTG	-15	-	+15	V
Vertical clock voltage	VP1AV, VP2AV VP1BV, VP2BV	-15	-	+15	V
Horizontal clock voltage	VP1AH, VP2AH VP1BH, VP2BH	-15	-	+15	V

■ Operating conditions (MPP mode, Ta=25 °C)

Parameter	Symbol	Min.	Typ.	Max.	Unit
Output transistor drain voltage	VOD	12	15	-	V
Reset drain voltage	VRD	12	13	14	V
Output gate voltage	VOG	-0.5	2	5	V
Output transistor ground voltage	VSSA	-	0	-	V
Substrate voltage	VSSD	-5	0	-	V
Test point	Vertical input source	VISV	-	VRD	-
	Vertical input gate	VIGV	-8	0	-
	Horizontal input gate	VIGH	-8	0	-
Vertical shift register clock voltage	High	VP1AVH, VP2AVH VP1BVH, VP2BVH	0	3	6
	Low	VP1AVL, VP2AVL VP1BVL, VP2BVL	-9	-8	-7
Horizontal shift register clock voltage	High	VP1AHH, VP2AHH VP1BHH, VP2BHH	0	3	6
	Low	VP1AHL, VP2AHL VP1BHL, VP2BHL	-9	-8	-7
Summing gate voltage	High	VSGH	0	3	6
	Low	VSSL	-9	-8	-7
Reset gate voltage	High	VRGH	0	3	6
	Low	VRGL	-9	-8	-7
Transfer gate voltage	High	VTGH	0	3	6
	Low	VTGL	-9	-8	-7

■ Electrical characteristics (Ta=25 °C)

Parameter	Symbol	Remark	Min.	Typ.	Max.	Unit
Signal output frequency	fc		-	2	4	MHz
Reset clock frequency	frg		-	2	4	MHz
Vertical shift register capacitance	CP1AV, CP2AV CP1BV, CP2BV		-	15000	-	pF
Horizontal shift register capacitance	CP1AH, CP2AH CP1BH, CP2BH		-	500	-	pF
Summing gate capacitance	CSG		-	15	-	pF
Reset gate capacitance	CRG		-	10	-	pF
Transfer gate capacitance	CTG		-	500	-	pF
Transfer efficiency	CTE	*2	0.99995	0.99999	-	
DC output level	Vout	*3	5	8	11	V
Output impedance	Zo	*3	-	500	-	Ω
Power dissipation	P	*3, *4	-	60	-	mW

*2: Measured at half of the full well capacity. CTE is defined per pixel.

*3: VOD=15 V.

*4: Power dissipation of the on-chip amplifier (each chip).

■ Electrical and optical characteristics (Ta=25 °C, unless otherwise noted)

Parameter		Symbol	Remark	Min.	Typ.	Max.	Unit	
Saturation output voltage		Vsat		-	Fw × Sv	-	V	
Full well capacity	Vertical	Fw		600	1200	-	ke ⁻	
	Horizontal			600	1200	-		
	Summing			600	1200	-		
CCD node sensitivity		Sv	*2	0.45	0.6	-	μV/e ⁻	
Dark current (MPP mode)		DS	*3	-	8	24	ke ⁻ /pixel/s	
Readout noise	Ta=25 °C	Nr	*4	-	90	-	e ⁻ rms	
	Ta=-40 °C			-	60	120		
Dynamic range		DR	*5	5000	20000	-		
X-ray response non-uniformity (S7199-01)		XRNU	*6	-	±10	±30	%	
Photo response non-uniformity (S7199-01F)		PRNU	*7					
Blemish	Point defects *8	White spots	-	-	-	10	-	
		Black spots		-	-	10		
	Cluster defects			*9	-	-		0
	Column defects			*10	-	-		0
X-ray resolution (S7199-01)		ΔR		4	6	-	Lp/mm	

*2: VOD=15 V.

*3: Dark current doubles for every 5 to 7 °C.

*4: Operating frequency is 2 MHz.

*5: Dynamic range = Full well capacity / Readout noise

*6: X-ray irradiation of 60kVp, measured at half of the full well capacity.

$$XRNU (\%) = \frac{\text{Fixed pattern noise (peak to peak)}}{\text{Signal}} \times 100$$

Measuring region that is within 146.0 mm (H) × 6.0 mm (V) (refer to dimensional outline)

*7: Measured at one-half of the saturation output (full well capacity) using LED light (peak emission wavelength: 565 nm)

$$PRNU (\%) = \frac{\text{Fixed pattern noise (peak to peak)}}{\text{Signal}} \times 100$$

*8: White spots > 20 times of typ. dark signal (8 ke⁻/pixel/s).

Black spots > 50 % reduction in response relative to adjacent pixels, measured at half of the full well capacity.

*9: continuous 2 to 9 point defects.

*10: continuous >10 point defects.

■ Resolution (S7199-01)

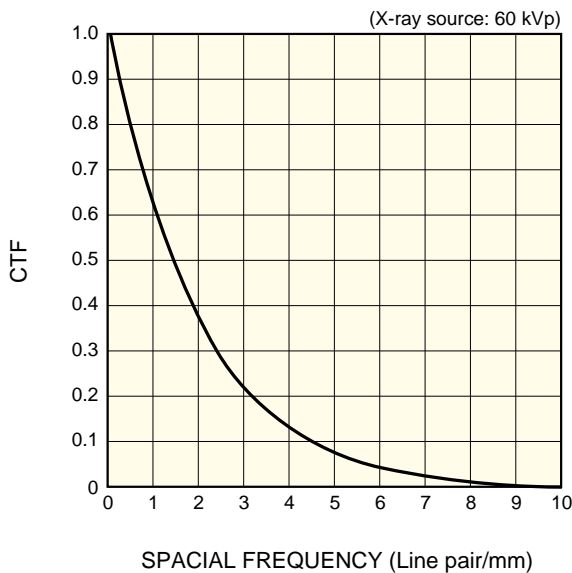

KMPDB0248EA

■ Response (S7199-01)

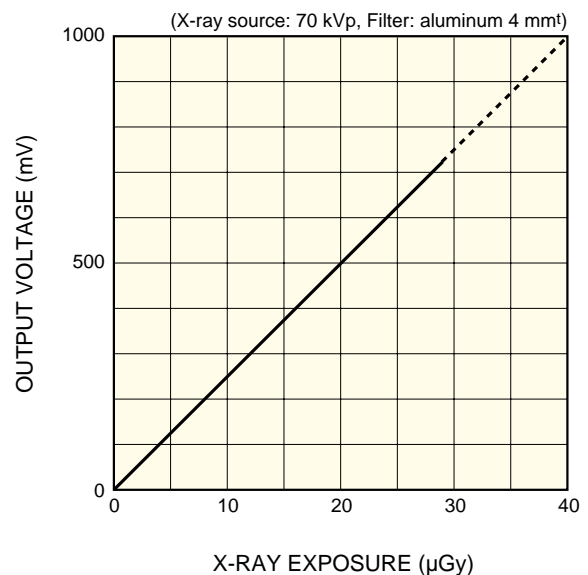

KMPDB0248EB

■ Device structure

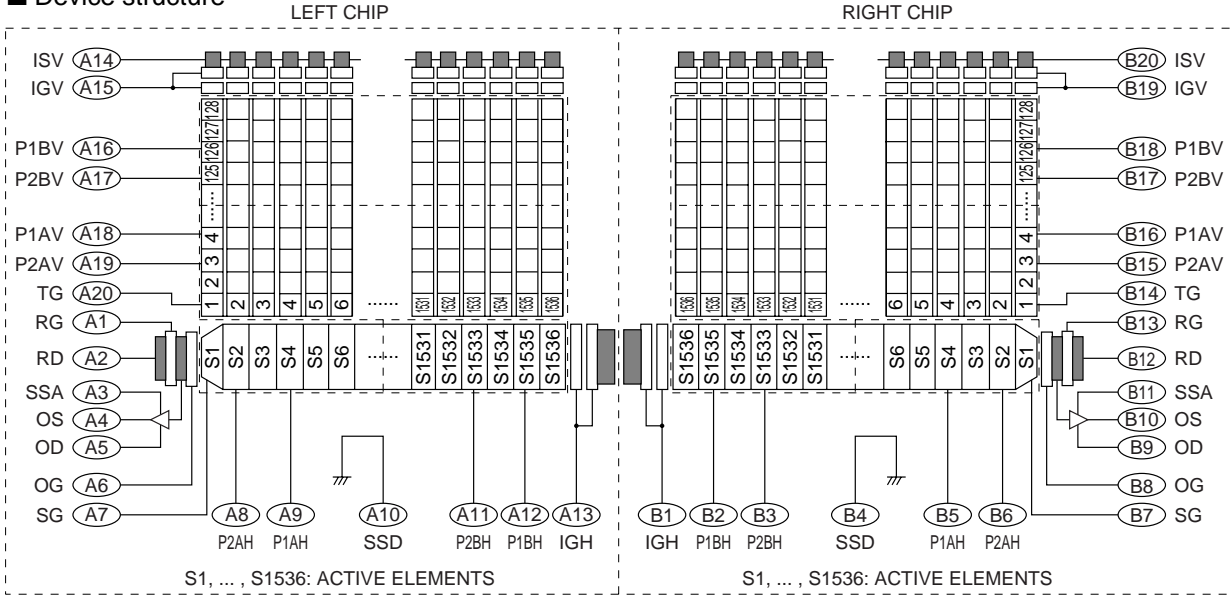

KMPDC0110EA

■ Pixel format

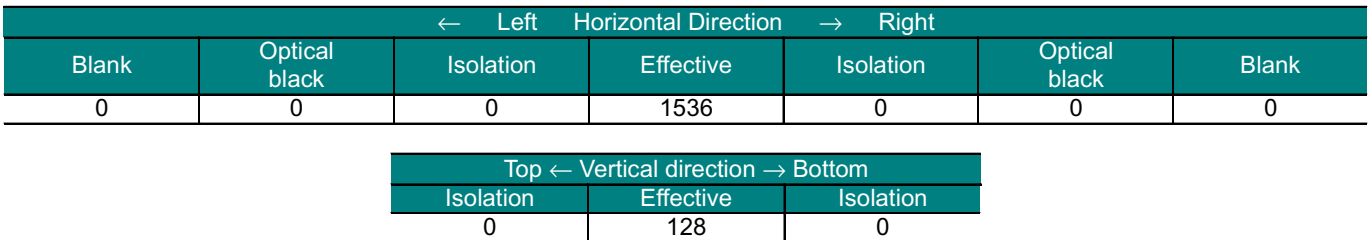

■ Timing chart (TDI operation)

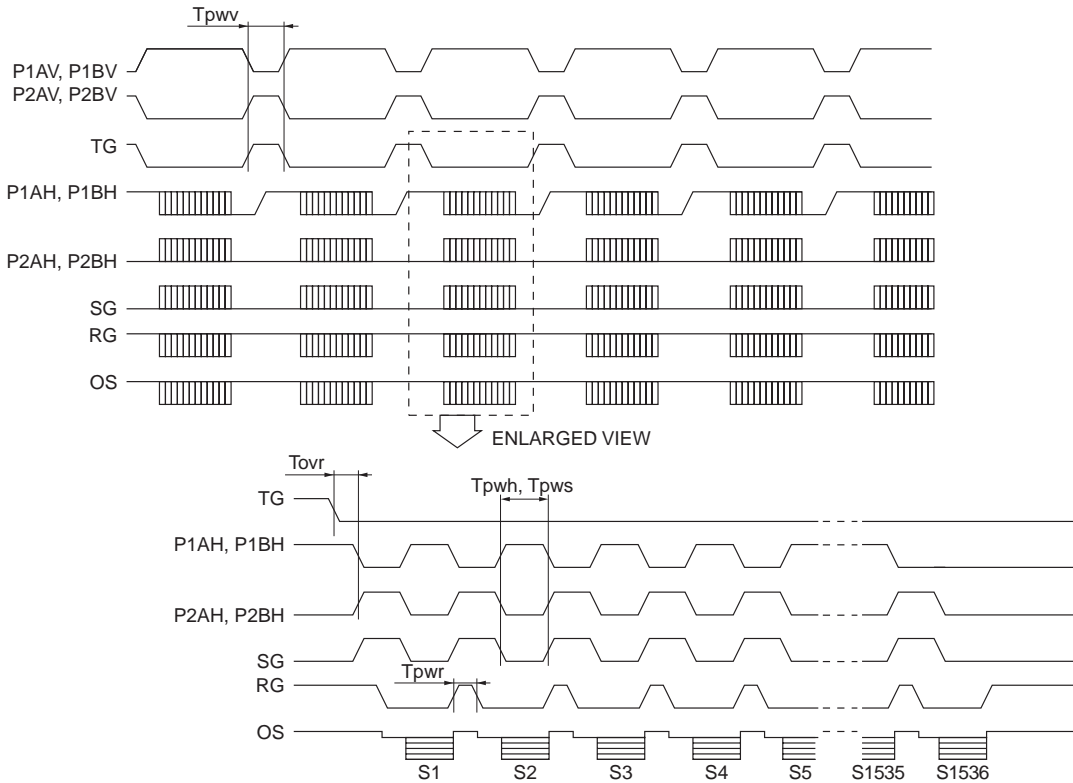

KMPDC0142EB

■ Timing chart (TDI operation, 2 × 2 pixel binning)

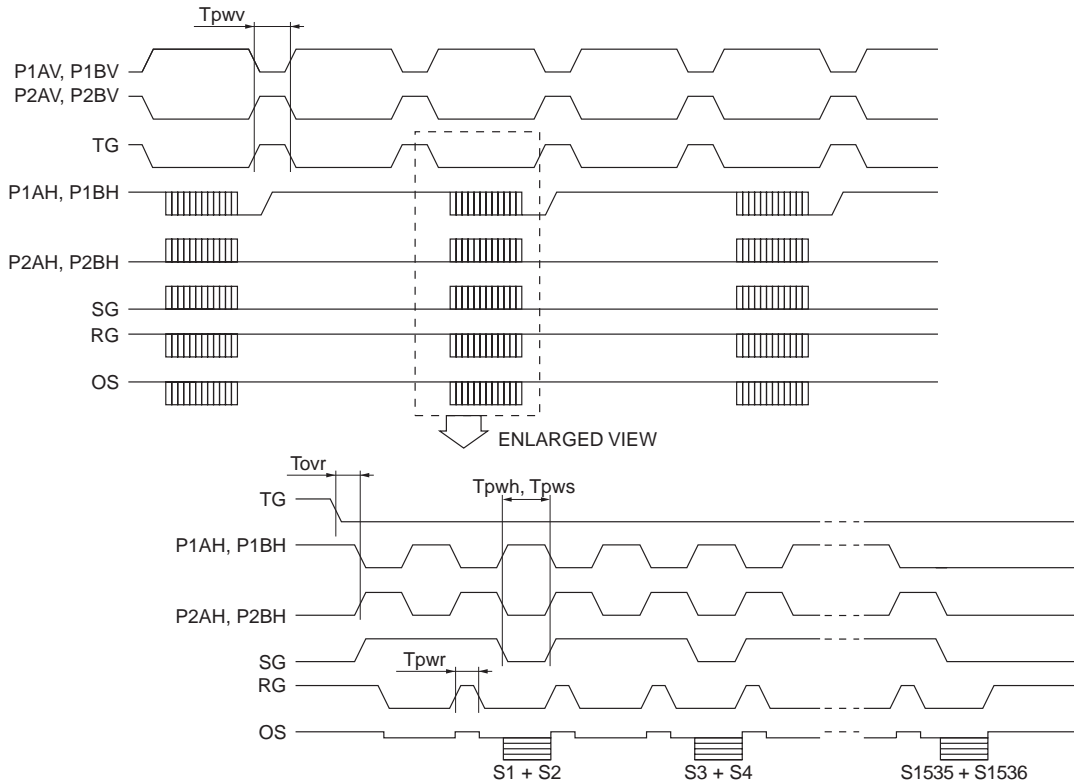

KMPDC0111EC

Parameter		Symbol	Remark	Min.	Typ.	Max.	Unit
P1AV, P1BV, P2AV, P2BV, TG	Pulse width	tpwv	*14, *15	30	60	-	μs
	Rise and fall time	tprv, tprf		200	-	-	ns
P1AH, P1BH, P2AH, P2BH	Pulse width	tpwh	*15	125	250	-	ns
	Rise and fall time	tprh, tprf		10	-	-	ns
	Duty ratio			-	50	-	%
SG	Pulse width	tpws		125	250	-	ns
	Rise and fall time	tprs, tpfs		10	-	-	ns
	Duty ratio			-	50	-	%
RG	Pulse width	tpwr		10	50	-	ns
	Rise and fall time	tpr, tprf		5	-	-	ns
TG-P1AH, P1BH	Overlap time	tovr		10	20	-	μs

*14: TG terminal can be short-circuited to P2AV terminal.

*15: Symmetrical pulses should be overlapped at 50 % of maximum amplitude.

■ Dimensional outline (unit: mm)

S7199-01

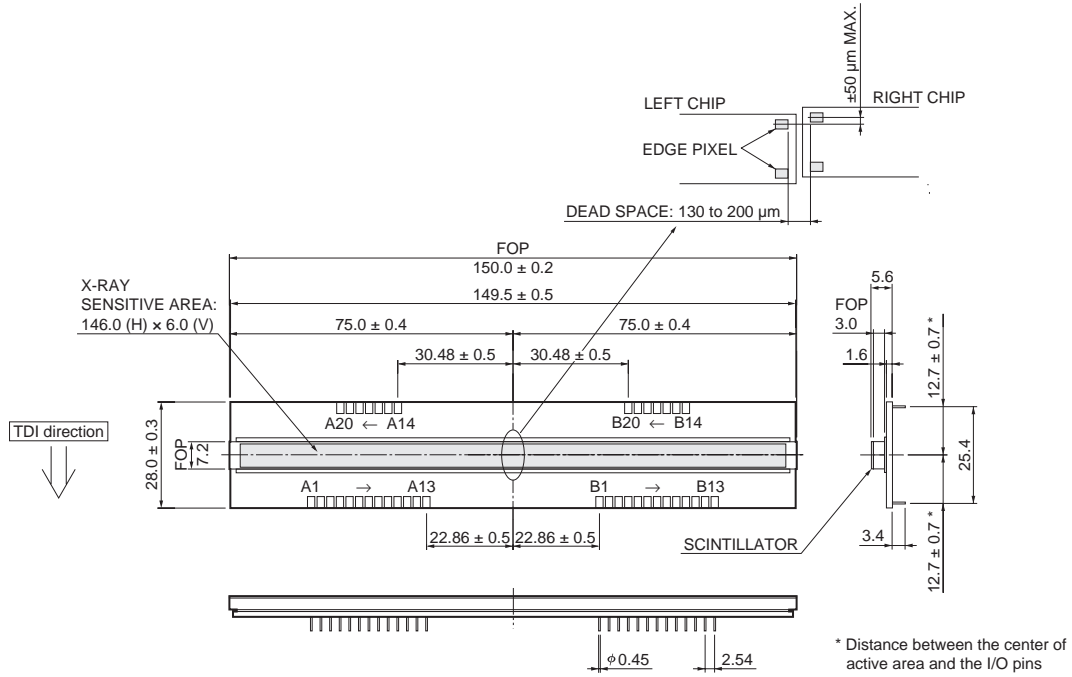

KMPDA0129EB

S7199-01F

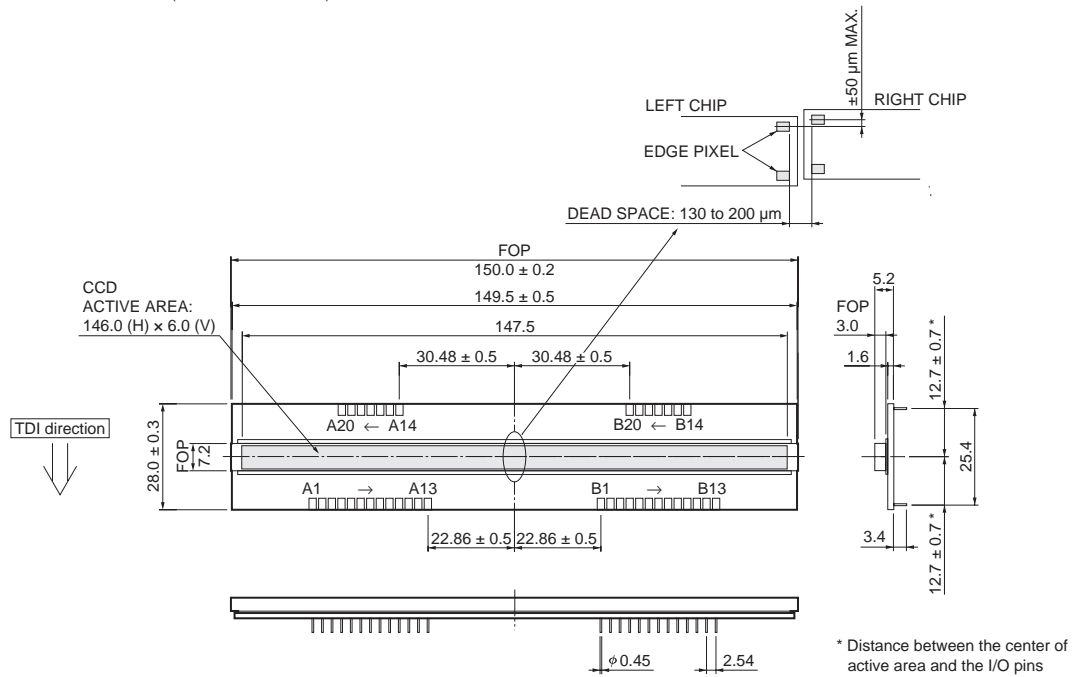

KMPDA0282EB

■ Pin connections

Pin No.	Symbol	Description	Remark
A1	RG	Reset gate	
A2	RD	Reset drain	
A3	SSA	Analog ground	
A4	OS	Output transistor source	
A5	OD	Output transistor drain	
A6	OG	Output gate	
A7	SG	Summing gate	
A8	P2AH	CCD horizontal register clock A-2	
A9	P1AH	CCD horizontal register clock A-1	
A10	SSD	Digital ground	
A11	P2BH	CCD horizontal register clock B-2	Same timing as P2AH
A12	P1BH	CCD horizontal register clock B-1	Same timing as P1AH
A13	IGH	Test point (Horizontal input gate)	
A14	ISV	Test point (Vertical input source)	Shorted to RD
A15	IGV	Test point (Vertical input gate)	
A16	P1BV	CCD vertical register clock B-1	Same timing as P1AV
A17	P2BV	CCD vertical register clock B-2	Same timing as P2AV
A18	P1AV	CCD vertical register clock A-1	
A19	P2AV	CCD vertical register clock A-2	
A20	TG	Transfer gate	
B1	IGH	Test point (Horizontal input gate)	
B2	P1BH	CCD horizontal register clock B-1	Same timing as P1AH
B3	P2BH	CCD horizontal register clock B-2	Same timing as P2AH
B4	SSD	Digital ground	
B5	P1AH	CCD horizontal register clock A-1	
B6	P2AH	CCD horizontal register clock A-2	
B7	SG	Summing gate	
B8	OG	Output gate	
B9	OD	Output transistor drain	
B10	OS	Output transistor source	
B11	SSA	Analog ground	
B12	RD	Reset drain	
B13	RG	Reset gate	
B14	TG	Transfer gate	
B15	P2AV	CCD vertical register clock A-2	
B16	P1AV	CCD vertical register clock A-1	
B17	P2BV	CCD vertical register clock B-2	Same timing as P2AV
B18	P1BV	CCD vertical register clock B-1	Same timing as P1AV
B19	IGV	Test point (Vertical input gate)	
B20	ISV	Test Point (Vertical input source)	Shorted to RD

■ Precautions for use (Electrostatic countermeasures)

- * Handle these sensors with bare hands or wearing cotton gloves. In addition, wear anti-static clothing or use a wrist band with an earth ring, in order to prevent electrostatic damage due to electrical charges from friction.
- * Avoid directly placing these sensors on a work-desk or work-bench that may carry an electrostatic charge.
- * Provide ground lines or ground connection with the work-floor, work-desk and work-bench to allow static electricity to discharge.
- * Ground the tools used to handle these sensors, such as tweezers and soldering irons.

It is not always necessary to provide all the electrostatic measures stated above. Implement these measures according to the amount of damage that occurs.

Information described in this material is current as of March, 2011. Product specifications are subject to change without prior notice due to improvements or other reasons. Before assembly into final products, please contact us for the delivery specification sheet to check the latest information.

Type numbers of products listed in the delivery specification sheets or supplied as samples may have a suffix "(X)" which means preliminary specifications or a suffix "(Z)" which means developmental specifications.

The product warranty is valid for one year after delivery and is limited to product repair or replacement for defects discovered and reported to us within that one year period. However, even if within the warranty period we accept absolutely no liability for any loss caused by natural disasters or improper product use.

Copying or reprinting the contents described in this material in whole or in part is prohibited without our prior permission.

HAMAMATSU

HAMAMATSU PHOTONICS K.K., Solid State Division

1126-1 Ichino-cho, Higashi-ku, Hamamatsu City, 435-8558 Japan, Telephone: (81) 53-434-3311, Fax: (81) 53-434-5184, www.hamamatsu.com

U.S.A.: Hamamatsu Corporation: 360 Foothill Road, P.O.Box 6910, Bridgewater, N.J. 08807-0910, U.S.A., Telephone: (1) 908-231-0960, Fax: (1) 908-231-1218

Germany: Hamamatsu Photonics Deutschland GmbH: Arzbergerstr. 10, D-82211 Herrsching am Ammersee, Germany, Telephone: (49) 8152-375-0, Fax: (49) 8152-265-8

France: Hamamatsu Photonics France S.A.R.L.: 19, Rue du Saule Trapu, Parc du Moulin de Massy, 91882 Massy Cedex, France, Telephone: 33-(1) 69 53 71 00, Fax: 33-(1) 69 53 71 10

United Kingdom: Hamamatsu Photonics UK Limited: 2 Howard Court, 10 Tewin Road, Welwyn Garden City, Hertfordshire AL7 1BW, United Kingdom, Telephone: (44) 1707-294888, Fax: (44) 1707-325777

North Europe: Hamamatsu Photonics Norden AB: Smidesvägen 12, SE-171 41 Solna, Sweden, Telephone: (46) 8-509-031-00, Fax: (46) 8-509-031-01

Italy: Hamamatsu Photonics Italia S.R.L.: Strada della Moia, 1 int. 6, 20020 Arese, (Milano), Italy, Telephone: (39) 02-935-81-733, Fax: (39) 02-935-81-741