

# CAT24FC64

## 64K-Bit I<sup>2</sup>C Serial CMOS EEPROM

### FEATURES

- Fast mode I<sup>2</sup>C bus compatible\*
- Max clock frequency:
  - 400KHz for VCC=2.5V to 5.5V
- Schmitt trigger filtered inputs for noise suppression
- Low power CMOS technology
- 64-byte page write buffer
- Self-timed write cycle with auto-clear
- Industrial and extended temperature ranges
- 5 ms max write cycle time
- Write protect feature
  - entire array protected when WP at V<sub>IH</sub>
- 1,000,000 program/erase cycles
- 100 year data retention
- 8-pin DIP, 8-pin SOIC (JEDEC), 8-pin SOIC (EIAJ), 8-pin TSSOP and TDFN packages

### DESCRIPTION

The CAT24FC64 is a 64K-bit Serial CMOS EEPROM internally organized as 8,192 words of 8 bits each. Catalyst's advanced CMOS technology substantially reduces device power requirements. The CAT24FC64

features a 64-byte page write buffer. The device operates via the I<sup>2</sup>C bus serial interface and is available in 8-pin DIP, SOIC, TSSOP and TDFN packages.

### PIN CONFIGURATION

#### DIP Package (P, L, GL)

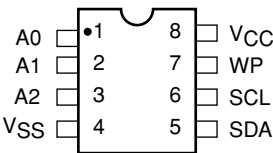

#### TDFN Package (RD2, ZD2)

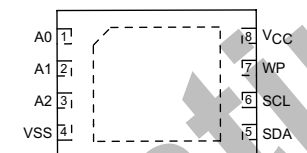

(Top View)

#### SOIC Package (J, W, K, X, GW, GX)

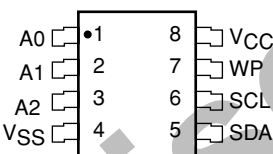

#### TSSOP Package (U, Y, GY)

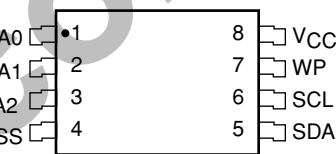

### PIN FUNCTIONS

Pin Name	Function
A0, A1, A2	Address Inputs
SDA	Serial Data/Address
SCL	Serial Clock
WP	Write Protect
V <sub>CC</sub>	+2.5V to +5.5V Power Supply
V <sub>SS</sub>	Ground
NC	No Connect

### BLOCK DIAGRAM

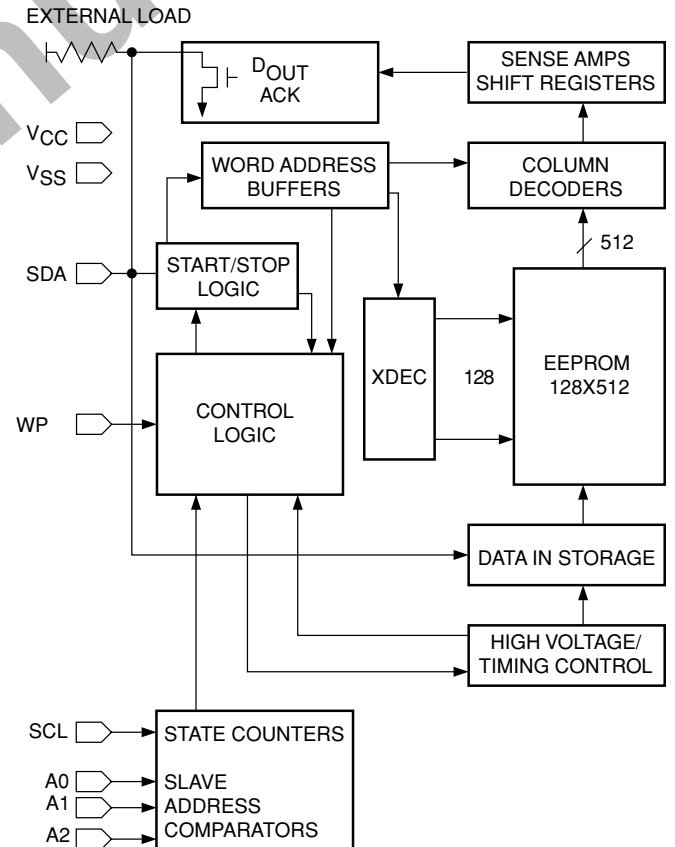

\* Catalyst Semiconductor is licensed by Philips Corporation to carry the I<sup>2</sup>C Bus Protocol.

**ABSOLUTE MAXIMUM RATINGS\***

Temperature Under Bias ..... -55°C to +125°C  
 Storage Temperature ..... -65°C to +150°C  
 Voltage on Any Pin with  
 Respect to Ground<sup>(1)</sup> ..... -2.0V to +V<sub>CC</sub> + 2.0V  
 V<sub>CC</sub> with Respect to Ground ..... -2.0V to +7.0V

Package Power Dissipation  
 Capability (T<sub>a</sub> = 25°C) ..... 1.0W  
 Lead Soldering Temperature (10 secs) ..... 300°C  
 Output Short Circuit Current<sup>(2)</sup> ..... 100mA

**\*COMMENT**

Stresses above those listed under “Absolute Maximum Ratings” may cause permanent damage to the device. These are stress ratings only, and functional operation of the device at these or any other conditions outside of those listed in the operational sections of this specification is not implied. Exposure to any absolute maximum rating for extended periods may affect device performance and reliability.

**RELIABILITY CHARACTERISTICS <sup>(3)</sup>**

Symbol	Parameter	Min	Typ	Max	Units
N <sub>END</sub>	Endurance	1,000,000			Cycles/Byte
T <sub>DR</sub>	Data Retention	100			Years
V <sub>ZAP</sub>	ESD Susceptibility	4000			Volts
I <sub>LTH</sub> <sup>(4)</sup>	Latch-up	100			mA

**D.C. OPERATING CHARACTERISTICS**

V<sub>CC</sub> = +2.5V to +5.5V, unless otherwise specified.

Symbol	Parameter	Test Conditions	Min	Typ	Max	Units
I <sub>CC1</sub>	Power Supply Current - Read	f <sub>SCL</sub> = 400 KHz V <sub>CC</sub> =5V			1	mA
I <sub>CC2</sub>	Power Supply Current - Write	f <sub>SCL</sub> = 400KHz V <sub>CC</sub> =5V			3	mA
I <sub>SB</sub> <sup>(5)</sup>	Standby Current	V <sub>IN</sub> = GND or V <sub>CC</sub> V <sub>CC</sub> =5V			1	μA
I <sub>LI</sub>	Input Leakage Current	V <sub>IN</sub> = GND to V <sub>CC</sub>			1	μA
I <sub>LO</sub>	Output Leakage Current	V <sub>OUT</sub> = GND to V <sub>CC</sub>			1	μA
V <sub>IL</sub>	Input Low Voltage		-0.5		V <sub>CC</sub> × 0.3	V
V <sub>IH</sub>	Input High Voltage		V <sub>CC</sub> × 0.7		V <sub>CC</sub> + 0.5	V
V <sub>OL</sub>	Output Low Voltage (V <sub>CC</sub> = +3.0V)	I <sub>OL</sub> = 3.0 mA			0.4	V

**CAPACITANCE** T<sub>A</sub> = 25°C, f = 1.0 MHz, V<sub>CC</sub> = 5V

Symbol	Test	Conditions	Min	Typ	Max	Units
C <sub>I/O</sub> <sup>(3)</sup>	Input/Output Capacitance (SDA)	V <sub>I/O</sub> = 0V			8	pF
C <sub>IN</sub> <sup>(3)</sup>	Input Capacitance (SCL, WP, A0, A1)	V <sub>IN</sub> = 0V			6	pF
Z <sub>WPL</sub>	WP Input Impedance	V <sub>IN</sub> ≤ 0.5V	5		70	kΩ
Z <sub>WPH</sub>	WP Input Impedance	V <sub>IN</sub> >0.7V×V <sub>CC</sub>	500			kΩ

Note:

- (1) The minimum DC input voltage is -0.5V. During transitions, inputs may undershoot to -2.0V for periods of less than 20 ns. Maximum DC voltage on output pins is V<sub>CC</sub> + 0.5V, which may overshoot to V<sub>CC</sub> + 2.0V for periods of less than 20ns.
- (2) Output shorted for no more than one second. No more than one output shorted at a time.
- (3) These parameters are tested initially and after a design or process change that affects the parameter according to appropriate AEC-Q100 and JEDEC test methods.
- (4) Latch-up protection is provided for stresses up to 100 mA on address and data pins from -1V to V<sub>CC</sub> + 1V.
- (5) Maximum standby current (I<sub>SB</sub>) = 10μA for the Extended Automotive temperature range.

**A.C. CHARACTERISTICS**

$V_{CC} = +2.5V$  to  $+5.5V$ , unless otherwise specified  
 Output Load is 1 TTL Gate and 100pF

**Read & Write Cycle Limits**

Symbol	Parameter	VCC=2.5V - 5.5V		Units
		Min	Max	
$F_{SCL}$	Clock Frequency		400	kHz
$t_{AA}$	SCL Low to SDA Data Out and ACK Out	50	900	ns
$t_{BUF}^{(2)}$	Time the Bus Must be Free Before a New Transmission Can Start	1300		ns
$t_{HD:STA}$	Start Condition Hold Time	600		ns
$t_{LOW}$	Clock Low Period	1300		ns
$t_{HIGH}$	Clock High Period	600		ns
$t_{SU:STA}$	Start Condition Setup Time (for a Repeated Start Condition)	600		ns
$t_{HD:DAT}$	Data In Hold Time	0		ns
$t_{SU:DAT}$	Data In Setup Time	100		ns
$t_R^{(2)}$	SDA and SCL Rise Time		300	ns
$t_F^{(2)}$	SDA and SCL Fall Time		300	ns
$t_{SU:STO}$	Stop Condition Setup Time	600		ns
$t_{DH}$	Data Out Hold Time	50		ns
$t_{WR}$	Write Cycle Time		5	ms
$t_{SP}$	Input Suppresssion (SDA, SCL)		50	ns
$t_{SU:WP}$	WP Setup Time	600		ns
$t_{HD:WP}$	WP Hold Time	1300		ns

**Power-Up Timing (2)(3)**

Symbol	Parameter	Min	Typ	Max	Units
$t_{PUR}$	Power-Up to Read Operation			100	$\mu s$
$t_{PUW}$	Power-Up to Write Operation			100	$\mu s$

Note:

- (1) AC measurement conditions:  
 RL (connects to  $V_{CC}$ ):  $0.3V_{CC}$  to  $0.7V_{CC}$   
 Input rise and fall times:  $\leq 50ns$   
 Input and output timing reference voltages:  $0.5V_{CC}$
- (2) This parameter is tested initially and after a design or process change that affects the parameter.
- (3)  $t_{PUR}$  and  $t_{PUW}$  are the delays required from the time  $V_{CC}$  is stable until the specified operation can be initiated.

The write cycle time is the time from a valid stop condition of a write sequence to the end of the internal program/erase cycle. During the write cycle, the bus

interface circuits are disabled, SDA is allowed to remain high, and the device does not respond to its slave address.

### FUNCTIONAL DESCRIPTION

The CAT24FC64 supports the I<sup>2</sup>C Bus data transmission protocol. This Inter-Integrated Circuit Bus protocol defines any device that sends data to the bus to be a transmitter and any device receiving data to be a receiver. The transfer is controlled by the Master device which generates the serial clock and all START and STOP conditions for bus access. The CAT24FC64 operates as a Slave device. Both the Master device and Slave device can operate as either transmitter or receiver, but the Master device controls which mode is activated.

### SDA: Serial Data/Address

The bidirectional serial data/address pin is used to transfer all data into and out of the device. The SDA pin is an open drain output and can be wire-ORed with other open drain or open collector outputs.

### WP: Write Protect

This input, when tied to GND, allows write operations to the entire memory. When this pin is tied to Vcc, the entire memory is write protected. When left floating, memory is unprotected.

### A0, A1, A2: Device Address Inputs

These pins are hardwired or left connected. When hardwired, up to eight CAT24FC64's may be addressed on a single bus system. When the pins are left unconnected, the default values are zero.

### PIN DESCRIPTIONS

#### SCL: Serial Clock

The serial clock input clocks all data transferred into or out of the device.

Figure 1. Bus Timing

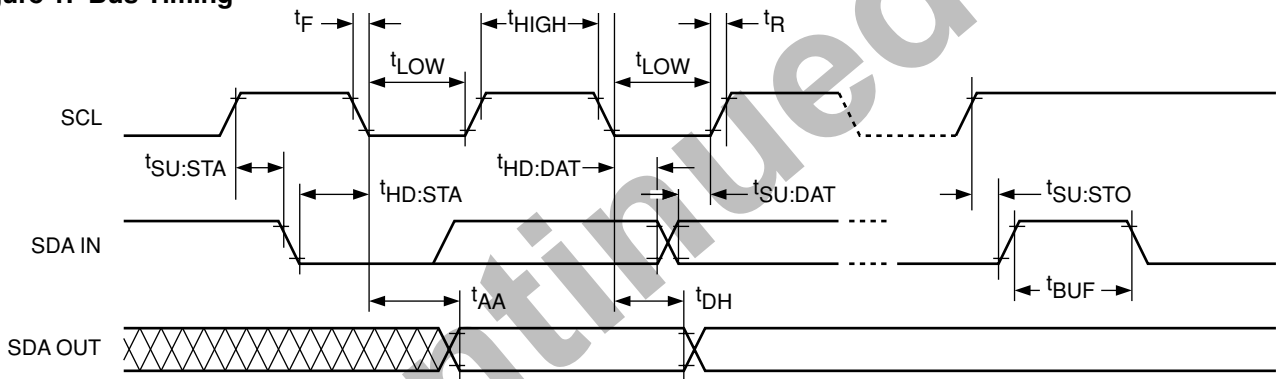

Figure 2. Write Cycle Timing

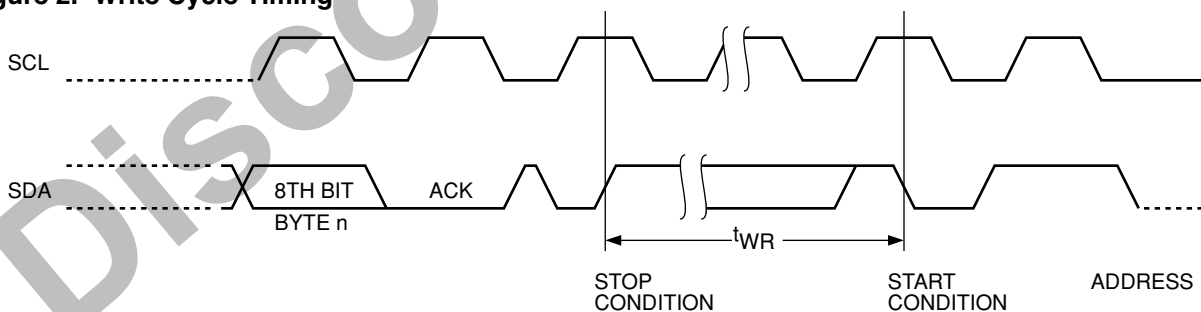
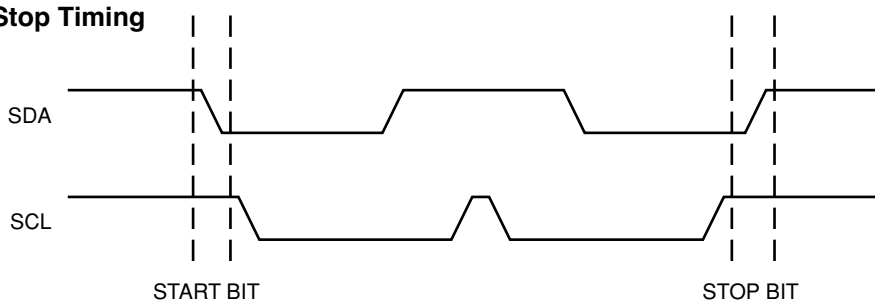

Figure 3. Start/Stop Timing



## I<sup>2</sup>C BUS PROTOCOL

The features of the I<sup>2</sup>C bus protocol are defined as follows:

- (1) Data transfer may be initiated only when the bus is not busy.
- (2) During a data transfer, the data line must remain stable whenever the clock line is high. Any changes in the data line while the clock line is high will be interpreted as a START or STOP condition.

### START Condition

The START Condition precedes all commands to the device, and is defined as a HIGH to LOW transition of SDA when SCL is HIGH. The CAT24FC64 monitors the SDA and SCL lines and will not respond until this condition is met.

### STOP Condition

A LOW to HIGH transition of SDA when SCL is HIGH determines the STOP condition. All operations must end with a STOP condition.

## DEVICE ADDRESSING

The bus Master begins a transmission by sending a START condition. The Master sends the address of the particular slave device it is requesting. The four most significant bits of the 8-bit slave address are fixed as 1010 (Fig. 5). The CAT24FC64 uses the next three bits as address bits. The address bits A2, A1 and A0 allow

as many as eight devices on the same bus. These bits must compare to their hardwired input pins. The last bit of the slave address specifies whether a Read or Write operation is to be performed. When this bit is set to 1, a Read operation is selected, and when set to 0, a Write operation is selected.

After the Master sends a START condition and the slave address byte, the CAT24FC64 monitors the bus and responds with an acknowledge (on the SDA line) when its address matches the transmitted slave address. The CAT24FC64 then performs a Read or Write operation depending on the state of the R/W bit.

### Acknowledge

After a successful data transfer, each receiving device is required to generate an acknowledge. The Acknowledging device pulls down the SDA line during the ninth clock cycle, signaling that it received the 8 bits of data.

The CAT24FC64 responds with an acknowledge after receiving a START condition and its slave address. If the device has been selected along with a write operation, it responds with an acknowledge after receiving each 8-bit byte.

When the CAT24FC64 begins a READ mode it transmits 8 bits of data, releases the SDA line, and monitors the line for an acknowledge. Once it receives this acknowledge, the CAT24FC64 will continue to transmit

**Figure 4. Acknowledge Timing**

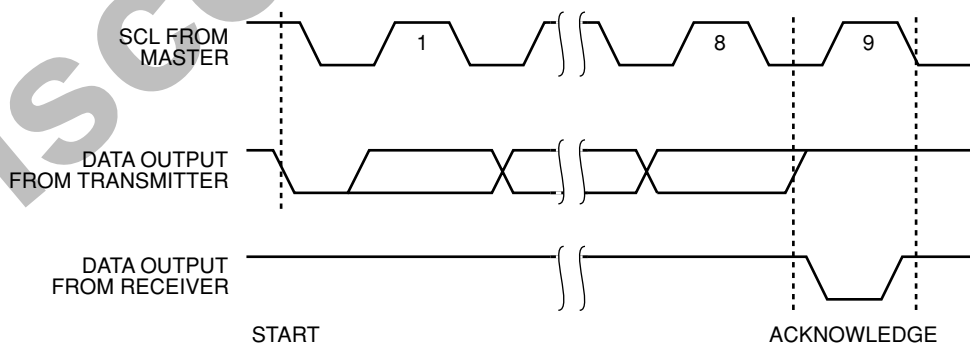

**Figure 5. Slave Address Bits**

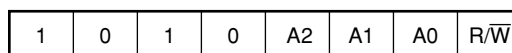

data. If no acknowledge is sent by the Master, the device terminates data transmission and waits for a STOP condition.

## WRITE OPERATIONS

### Byte Write

In the Byte Write mode, the Master device sends the START condition and the slave address information (with the R/W bit set to zero) to the Slave device. After the Slave generates an acknowledge, the Master sends two 8-bit address words that are to be written into the address pointers of the CAT24FC64. After receiving another acknowledge from the Slave, the Master device transmits the data to be written into the addressed memory location. The CAT24FC64 acknowledges once more and the Master generates the STOP condition. At this time, the device begins an internal programming cycle to nonvolatile memory. While the cycle is in progress, the device will not respond to any request from the Master device.

### Page Write

The CAT24FC64 writes up to 64 bytes of data, in a single write cycle, using the Page Write operation. The page write operation is initiated in the same manner as the byte write operation, however instead of terminating after the initial byte is transmitted, the Master is allowed to send up to 63 additional bytes. After each byte has been transmitted, CAT24FC64 will respond with an acknowledge, and internally increment the six low order address bits by one. The high order bits remain unchanged.

If the Master transmits more than 64 bytes before sending the STOP condition, the address counter 'wraps around', and previously transmitted data will be overwritten.

When all 64 bytes are received, and the STOP condition has been sent by the Master, the internal programming cycle begins. At this point, all received data is written to the CAT24FC64 in a single write cycle.

### Acknowledge Polling

Disabling of the inputs can be used to take advantage of the typical write cycle time. Once the stop condition is issued to indicate the end of the host's write operation, CAT24FC64 initiates the internal write cycle. ACK polling can be initiated immediately. This involves issuing the start condition followed by the slave address for a write operation. If CAT24FC64 is still busy with the write operation, no ACK will be returned. If CAT24FC64 has completed the write operation, an ACK will be returned and the host can then proceed with the next read or write operation.

## WRITE PROTECTION

The Write Protection feature allows the user to protect against inadvertent programming of the memory array. If the WP pin is tied to V<sub>CC</sub>, the entire memory array is protected and becomes read only. The CAT24FC64 will accept both slave and byte addresses, but the memory location accessed is protected from programming by the device's failure to send an acknowledge after the first byte of data is received.

Figure 6. Byte Write Timing

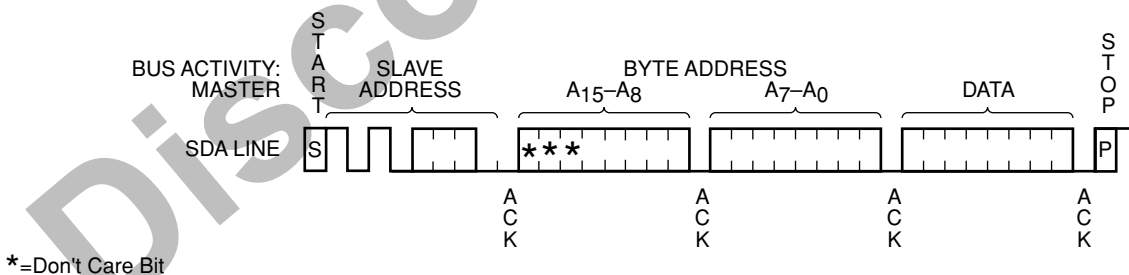
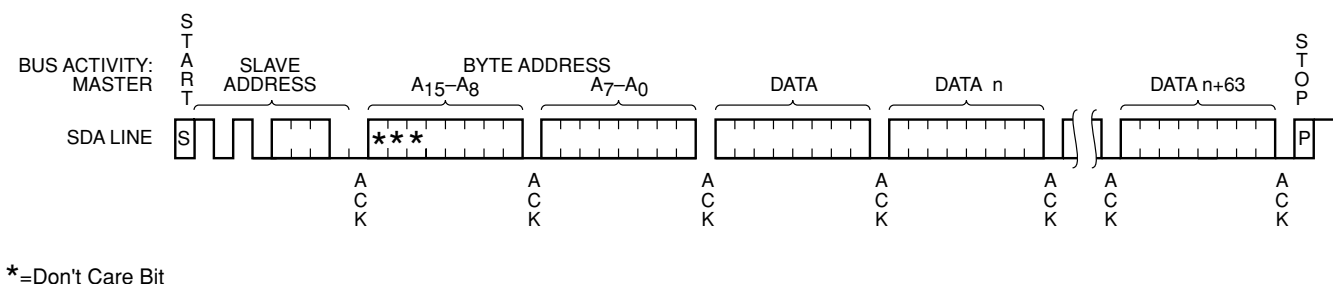

Figure 7. Page Write Timing



## READ OPERATIONS

The READ operation for the CAT24FC64 is initiated in the same manner as the write operation with one exception, that  $R/\bar{W}$  bit is set to one. Three different READ operations are possible: Immediate/Current Address READ, Selective/Random READ and Sequential READ.

### Immediate/Current Address Read

The CAT24FC64's address counter contains the address of the last byte accessed, incremented by one. In other words, if the last READ or WRITE access was to address N, the READ immediately following would access data from address N+1. If N=E (where E=8,191), then the counter will 'wrap around' to address 0 and continue to clock out data. After the CAT24FC64 receives its slave address information (with the  $R/\bar{W}$  bit set to one), it issues an acknowledge, then transmits the 8 bit byte requested. The master device does not send an acknowledge, but will generate a STOP condition.

### Selective/Random Read

Selective/Random READ operations allow the Master device to select at random any memory location for a READ operation. The Master device first performs a 'dummy' write operation by sending the START condition,

slave address and byte addresses of the location it wishes to read. After CAT24FC64 acknowledges, the Master device sends the START condition and the slave address again, this time with the  $R/\bar{W}$  bit set to one. The CAT24FC64 then responds with its acknowledge and sends the 8-bit byte requested. The master device does not send an acknowledge but will generate a STOP condition.

### Sequential Read

The Sequential READ operation can be initiated by either the Immediate Address READ or Selective READ operations. After the CAT24FC64 sends the initial 8-bit byte requested, the Master will respond with an acknowledge which tells the device it requires more data. The CAT24FC64 will continue to output an 8-bit byte for each acknowledge sent by the Master. The operation will terminate when the Master fails to respond with an acknowledge, thus sending the STOP condition.

The data being transmitted from CAT24FC64 is outputted sequentially with data from address N followed by data from address N+1. The READ operation address counter increments all of the CAT24FC64 address bits so that the entire memory array can be read during one operation. If more than E (where E=8,191) bytes are read out, the counter will 'wrap around' and continue to clock out data bytes.

Figure 8. Immediate Address Read Timing

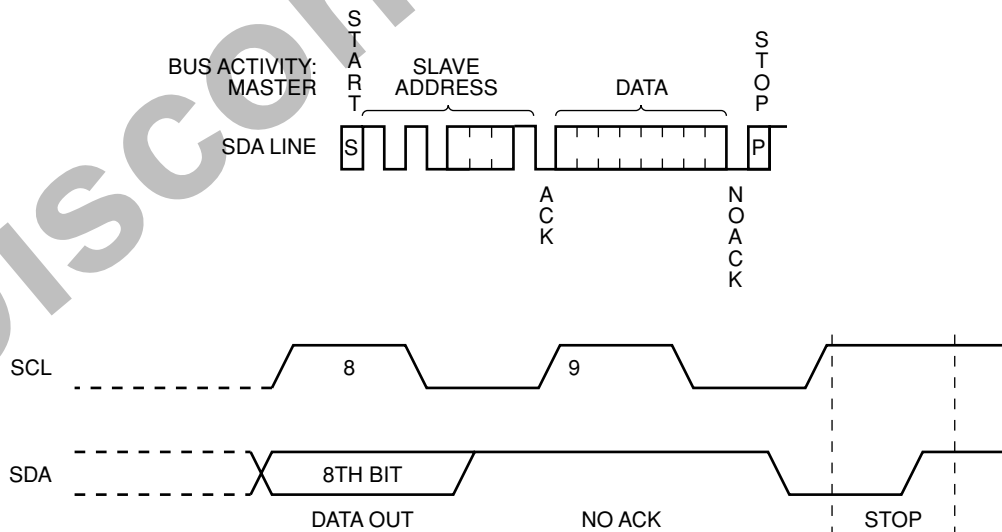
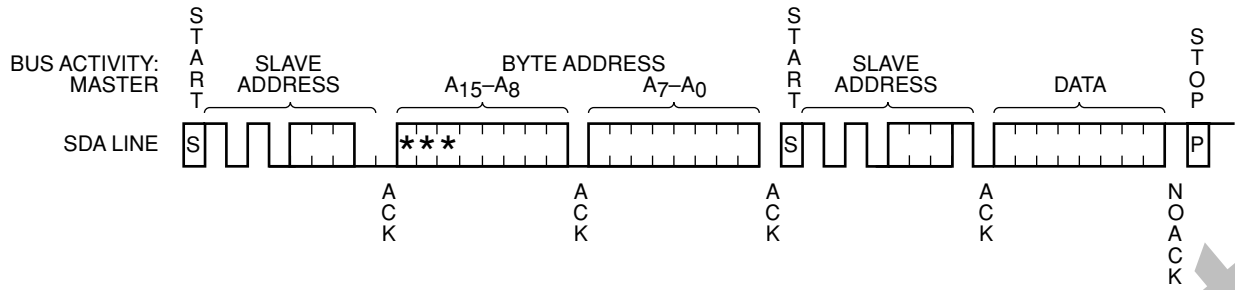
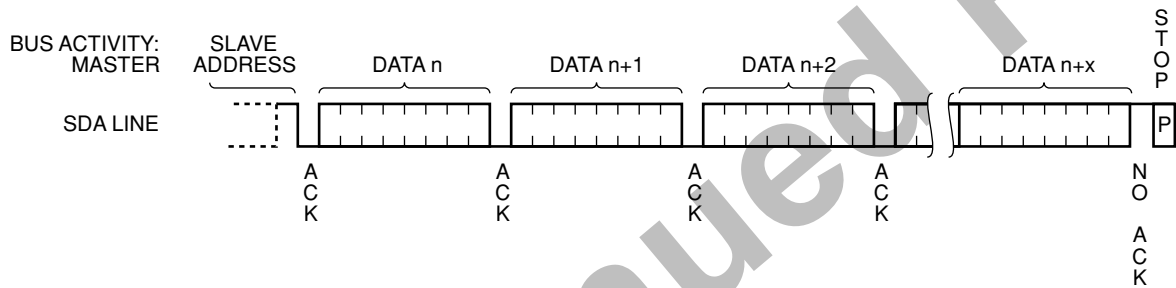

Figure 9. Selective Read Timing



\*=Don't Care Bit

Figure 10. Sequential Read Timing





**ORDERING INFORMATION**

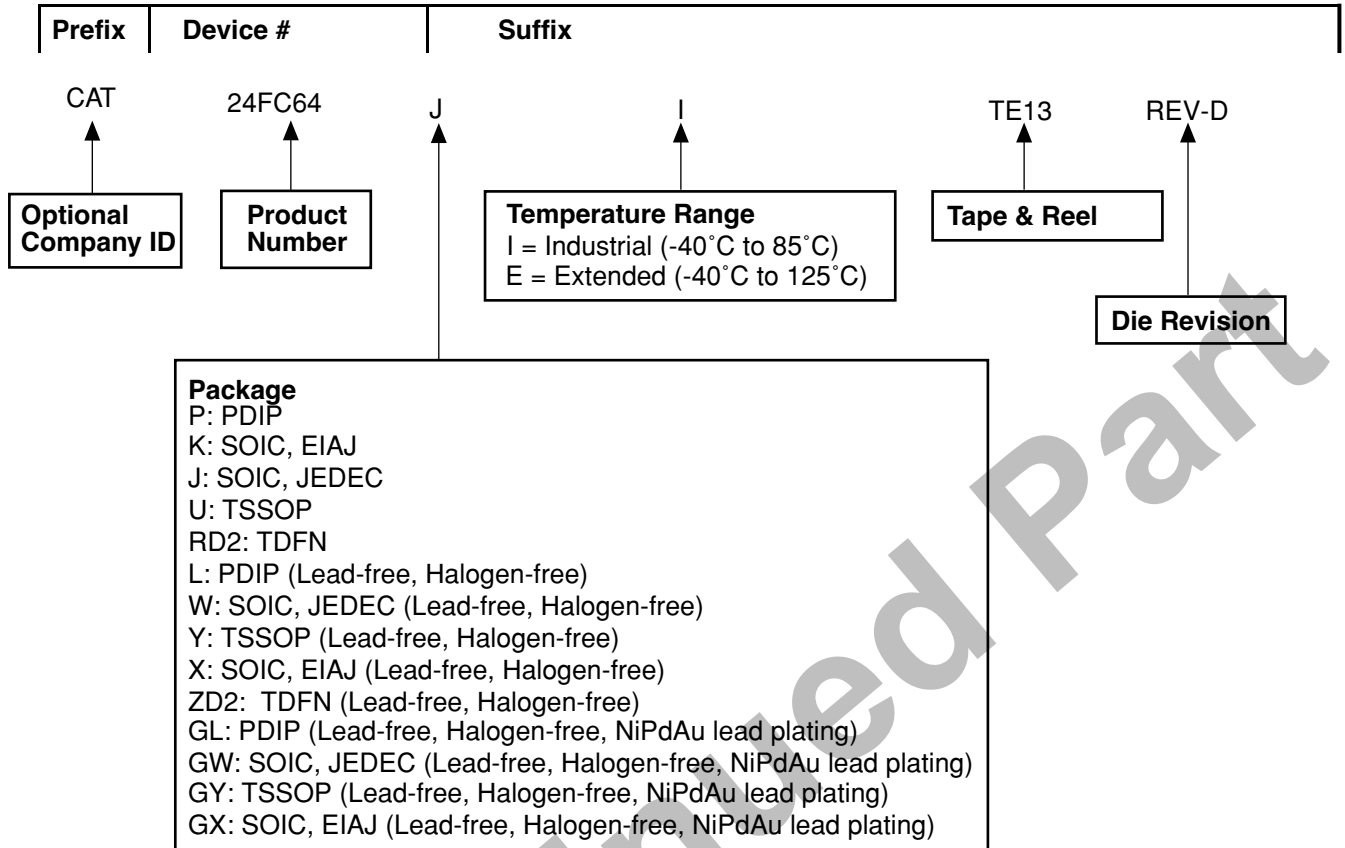

**Notes:**

(1) The device used in the above example is a 24FC64JI-TE13 REV-D (SOIC, Industrial Temperature, 2.5 Volt to 5.5 Volt Operating Voltage, Tape & Reel)

## REVISION HISTORY

Date	Revision	Comments
03/03/04	C	Added 8-pin TSSOP package (updated in all areas) Updated DC Operating Characteristics Updated Power-Up Timing
03/26/04	D	Changed Advance designation to Preliminary
04/02/04	E	Eliminated data sheet designation
05/15/04	F	Update Features Update D.C. Operating Characteristics Update Read & Write Cycle Limits Update Ordering Information Update Revision History Update Rev Number
06/07/04	G	Update AC Characteristics (Write Cycle Time)
7/27/04	H	Update notes on page 2
8/25/04	I	Update notes in Ordering Information section
03/24/05	J	Update Features Update Description Update Pin Functions Update Reliability Characteristics Update D.C. Operating Characteristics Update A.C. Characteristics Update Ordering Information
08/03/05	K	Update Pin Configuration Update Ordering Information

### Copyrights, Trademarks and Patents

Trademarks and registered trademarks of Catalyst Semiconductor include each of the following:

DPP™ AE²™ MiniPot™

Catalyst Semiconductor has been issued U.S. and foreign patents and has patent applications pending that protect its products. For a complete list of patents issued to Catalyst Semiconductor contact the Company's corporate office at 408.542.1000.

*CATALYST SEMICONDUCTOR MAKES NO WARRANTY, REPRESENTATION OR GUARANTEE, EXPRESS OR IMPLIED, REGARDING THE SUITABILITY OF ITS PRODUCTS FOR ANY PARTICULAR PURPOSE, NOR THAT THE USE OF ITS PRODUCTS WILL NOT INFRINGE ITS INTELLECTUAL PROPERTY RIGHTS OR THE RIGHTS OF THIRD PARTIES WITH RESPECT TO ANY PARTICULAR USE OR APPLICATION AND SPECIFICALLY DISCLAIMS ANY AND ALL LIABILITY ARISING OUT OF ANY SUCH USE OR APPLICATION, INCLUDING BUT NOT LIMITED TO, CONSEQUENTIAL OR INCIDENTAL DAMAGES.*

Catalyst Semiconductor products are not designed, intended, or authorized for use as components in systems intended for surgical implant into the body, or other applications intended to support or sustain life, or for any other application in which the failure of the Catalyst Semiconductor product could create a situation where personal injury or death may occur.

Catalyst Semiconductor reserves the right to make changes to or discontinue any product or service described herein without notice. Products with data sheets labeled "Advance Information" or "Preliminary" and other products described herein may not be in production or offered for sale.

Catalyst Semiconductor advises customers to obtain the current version of the relevant product information before placing orders. Circuit diagrams illustrate typical semiconductor applications and may not be complete.



Catalyst Semiconductor, Inc.

Corporate Headquarters

1250 Borregas Avenue

Sunnyvale, CA 94089

Phone: 408.542.1000

Fax: 408.542.1200

[www.catalyst-semiconductor.com](http://www.catalyst-semiconductor.com)

Publication #: 1046

Revision: K

Issue date: 08/03/05