



## MJE13005

## NPN SILICON TRANSISTOR

### NPN SILICON POWER TRANSISTORS

#### DESCRIPTION

These devices are designed for high-voltage, high-speed power switching inductive circuits where fall time is critical. They are particularly suited for 115 and 220 V SWITCHMODE.

#### FEATURES

- \*  $V_{CEO(SUS)} = 400\text{ V}$
- \* Reverse bias SOA with inductive loads @  $T_C = 100^\circ\text{C}$
- \* Inductive switching matrix 2 to 4 Amp, 25 and  $100^\circ\text{C}$  . . . tc @ 3A,  $100^\circ\text{C}$  is 180 ns (Typ)
- \* 700V blocking capability
- \* SOA and switching applications information

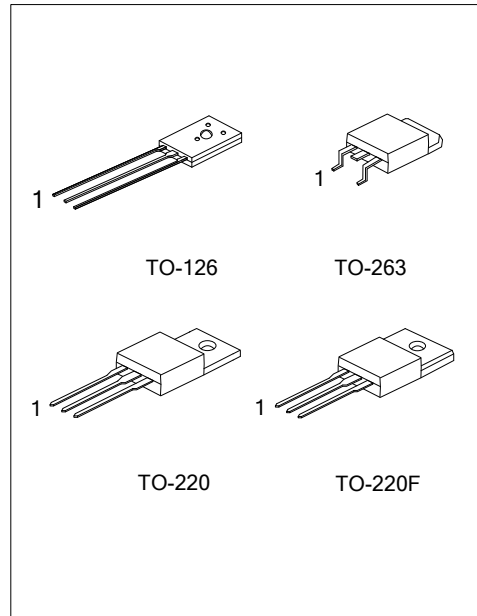

\*Pb-free plating product number: MJE13005L

#### APPLICATIONS

- \* Switching regulator's, inverters
- \* Motor controls
- \* Solenoid/Relay drivers
- \* Deflection circuits

#### ORDERING INFORMATION

Ordering Number		Package	Pin Assignment			Packing
Normal	Lead Free Plating		1	2	3	
MJE13005-T60-K	MJE13005L-T60-K	TO-126	B	C	E	Bulk
MJE13005-TA3-T	MJE13005L-TA3-T	TO-220	B	C	E	Tube
MJE13005-TF3-T	MJE13005L-TF3-T	TO-220F	B	C	E	Tube
MJE13005-TQ3-R	MJE13005L-TQ3-R	TO-263	B	C	E	Tape Reel
MJE13005-TQ3-T	MJE13005L-TQ3-T	TO-263	B	C	E	Tube

<p>MJE13005L-T60-K</p> <p>(1)Packing Type</p> <p>(2)Package Type</p> <p>(3)Lead Plating</p>	<p>(1)T: Tube, K: Bulk, R: Tape Reel</p> <p>(2) T60: TO-126, TA3: TO-220, TF3: TO-220F, TQ3: TO-263</p> <p>(3) L: Lead Free Plating, Blank: Pb/Sn</p>
---	---

## ■ ABSOLUTE MAXIMUM RATINGS

PARAMETER		SYMBOL	RATINGS	UNIT
Collector-Emitter Voltage		$V_{CEO(SUS)}$	400	V
Collector-Emitter Voltage		$V_{CBO}$	700	V
Emitter Base Voltage		$V_{EBO}$	9	V
Collector Current	Continuous	$I_C$	4	A
	Peak (1)	$I_{CM}$	8	A
Base Current	Continuous	$I_B$	2	A
	Peak (1)	$I_{BM}$	4	A
Emitter Current	Continuous	$I_E$	6	A
	Peak (1)	$I_{EM}$	12	A
Total Power Dissipation at $T_a=25^\circ\text{C}$ Derate above $25^\circ\text{C}$		$P_D$	2	W
			16	mW/ $^\circ\text{C}$
Total Power Dissipation at $T_c=25^\circ\text{C}$ Derate above $25^\circ\text{C}$		$P_D$	75	W
			600	mW/ $^\circ\text{C}$
Operating and Storage Junction Temperature Range		$T_J, T_{STG}$	-65 ~ +150	$^\circ\text{C}$

Note: Absolute maximum ratings are those values beyond which the device could be permanently damaged.  
Absolute maximum ratings are stress ratings only and functional device operation is not implied.

## ■ THERMAL DATA

PARAMETER	SYMBOL	MAX	UNIT
Thermal Resistance, Junction to Ambient	$\theta_{JA}$	62.5	$^\circ\text{C}/\text{W}$
Thermal Resistance, Junction to Case	$\theta_{JC}$	1.67	$^\circ\text{C}/\text{W}$

(1) Pulse Test : Pulse Width=5ms,Duty Cycle $\leq$ 10%

## ■ ELECTRICAL CHARACTERISTICS ( $T_c=25^\circ\text{C}$ , unless otherwise specified)

PARAMETER	SYMBOL	TEST CONDITIONS	MIN	TYP	MAX	UNIT
<b>*OFF CHARACTERISTICS (1)</b>						
Collector-Emitter Sustaining Voltage	$V_{CEO(SUS)}$	$I_C=10\text{mA}, I_B=0$	400			V
Collector Cutoff Current	$I_{CBO}$	$V_{CBO}=\text{Rated Value}, V_{BE(OFF)}=1.5\text{V}$			1	mA
		$V_{CBO}=\text{Rated Value}, V_{BE(OFF)}=1.5\text{V}, T_c=100^\circ\text{C}$			5	
Emitter Cutoff Current	$I_{EBO}$	$V_{EB}=9\text{V}, I_C=0$			1	mA
<b>SECOND BREAKDOWN</b>						
Second Breakdown Collector Current with base forward biased	$I_{s/b}$				See Figure 11	
Clamped Inductive SOA with Base Reverse Biased	RBSOA				See Figure 12	
<b>*ON CHARACTERISTICS (1)</b>						
DC Current Gain	$h_{FE1}$	$I_C=1\text{A}, V_{CE}=5\text{V}$	10		60	
	$h_{FE2}$	$I_C=2\text{A}, V_{CE}=5\text{V}$	8		40	
Collector-Emitter Saturation Voltage	$V_{CE(SAT)}$	$I_C=1\text{A}, I_B=0.2\text{A}$			0.5	V
		$I_C=2\text{A}, I_B=0.5\text{A}$			0.6	V
		$I_C=4\text{A}, I_B=1\text{A}$			1	V
		$I_C=2\text{A}, I_B=0.5\text{A}, T_a=100^\circ\text{C}$			1	V
Base-Emitter Saturation Voltage	$V_{BE(SAT)}$	$I_C=1\text{A}, I_B=0.2\text{A}$			1.2	V
		$I_C=2\text{A}, I_B=0.5\text{A}$			1.6	V
		$I_C=2\text{A}, I_B=0.5\text{A}, T_c=100^\circ\text{C}$			1.5	V
<b>DYNAMIC CHARACTERISTICS</b>						
Current-Gain-Bandwidth Product	$f_T$	$I_C=500\text{mA}, V_{CE}=10\text{V}, f=1\text{MHz}$	4			MHz
Output Capacitance	$C_{ob}$	$V_{CB}=10\text{V}, I_E=0, f=0.1\text{MHz}$		65		pF

## ELECTRICAL CHARACTERISTICS (Cont.)

PARAMETER	SYMBOL	TEST CONDITIONS	MIN	TYP	MAX	UNIT
<b>SWITCHING CHARACTERISTICS</b>						
Resistive Load (Table 1)						
Delay Time	$t_D$	$V_{CC}=125V, I_C=2A, I_{B1}=I_{B2}=0.4A,$ $t_p=25\mu s, \text{Duty Cycle}\leq 1\%$		0.025	0.1	$\mu s$
Rise Time	$t_R$			0.3	0.7	$\mu s$
Storage Time	$t_S$			1.7	4	$\mu s$
Fall Time	$t_F$			0.4	0.9	$\mu s$

\* Pulse Test: Pulse Width=300 $\mu s$ , Duty Cycle $\leq 2\%$

Table 1. Test Conditions for Dynamic Performance

REVERSE BIAS SAFE OPERATING AREA AND INDUCTIVE SWITCHING			RESISTIVE SWITCHING
TEST CIRCUITS			
CIRCUIT VALUES	<p>Coil Data :</p> <p>FERROXCUBE core #6656</p> <p>Full Bobbin (~ 16 Turns) #16</p>	<p>GAP for 200<math>\mu H</math>/20 A</p> <p><math>L_{coil}=200\mu H</math></p> <p><math>V_{CC}=20V</math></p> <p><math>V_{clamp}=300V</math></p>	<p><math>V_{CC}=125V</math></p> <p><math>R_C=62\Omega</math></p> <p><math>D1=1n5820</math> or Equiv.</p> <p><math>R_B=22\Omega</math></p>
TEST WAVEFORMS	<p>OUTPUT WAVEFORMS</p> <p><math>t_1</math> Adjusted to Obtain <math>I_C</math></p> $t_1 = \frac{L_{coil}(I_{Cpk})}{V_{CC}}$ $t_2 = \frac{L_{coil}(I_{Cpk})}{V_{clamp}}$ <p>Test Equipment Scope-Tektronics 475 or Equivalent</p>		<p><math>t_r, t_f &lt; 10ns</math></p> <p>Duty Cycle=1.0%</p> <p><math>R_B</math> and <math>R_C</math> adjusted for desired <math>I_B</math> and <math>I_C</math></p>

## RESISTIVE SWITCHING PERFORMANCE

Figure 1. Turn-On Time

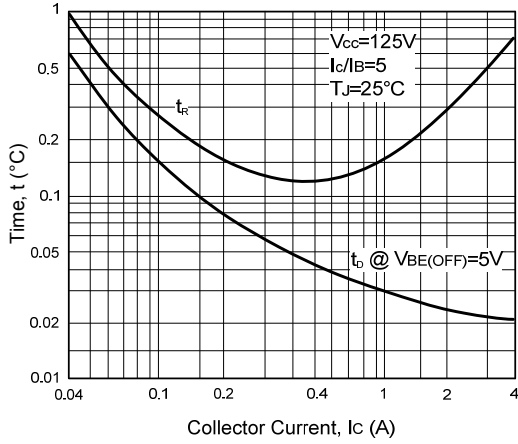

Figure 2. Turn-Off Time

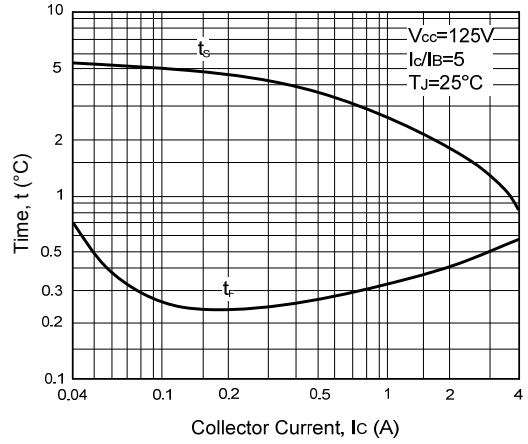

Figure 3. Typical Thermal Response [ $Z_{\theta JC}(t)$ ]

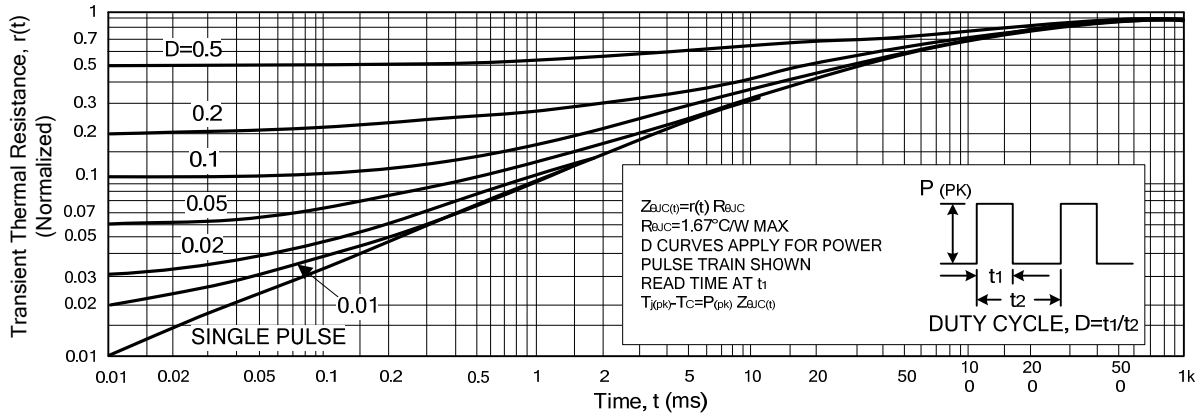

Figure 4. Forward Bias Safe Operating Area

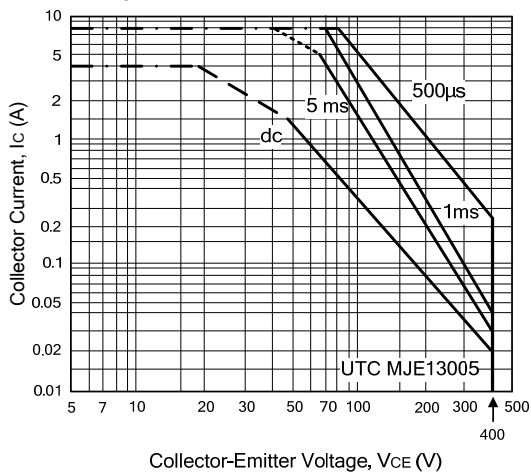
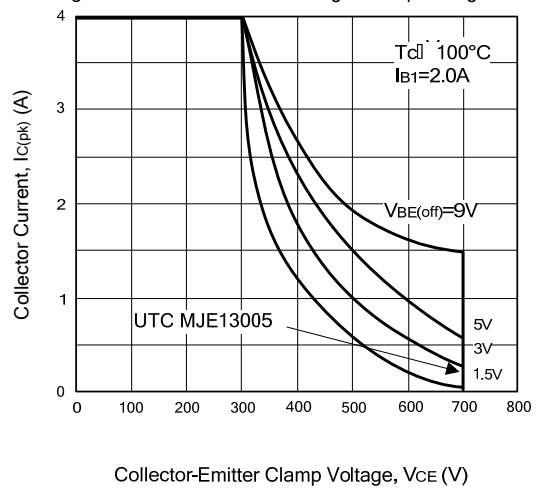
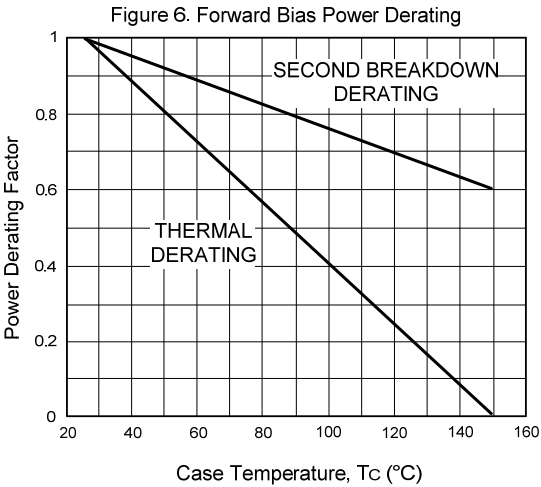

Figure 5. Reverse Bias Switching Safe Operating Area



■ RESISTIVE SWITCHING PERFORMANCE



### ■ SAFE OPERATING AREA INFORMATION

#### FORWARD BIAS

There are two limitations on the power handling ability of a transistor: average junction temperature and second breakdown. Safe operating area curves indicate  $I_C$ - $V_{CE}$  limits of the transistor that must be observed for reliable operation; e., the transistor must not be subjected to greater dissipation than the curves indicate.

The data of Figure 4 is based on  $T_C = 25^\circ\text{C}$ ;  $T_J(\text{pk})$  is variable depending on power level. Second breakdown pulse limits are valid for duty cycles to 10% but must be derated when  $T_C \geq 25^\circ\text{C}$ . Second breakdown limitations do not derate the same as thermal limitations. Allowable current at the voltages shown on Figure 4 may be found at any case temperature by using the appropriate curve on Figure 6.

$T_J(\text{pk})$  may be calculated from the data in Figure 10. At high case temperatures, thermal limitations will reduce the power that can be handled to values less than the limitations imposed by second breakdown.

#### REVERSE BIAS

For inductive loads, high voltage and high current must be sustained simultaneously during turn-off, in most cases, with the base to emitter junction reverse biased. Under these conditions the collector voltage must be held to a safe level at or below a specific value of collector current. This can be accomplished by several means such as active clamping, RC snubbing, load line shaping, etc. The safe level for these devices is specified as Reverse Bias Safe Operating Area and represents the voltage-current conditions during reverse biased turn-off. This rating is verified under clamped conditions so that the device is never subjected to an avalanche mode. Figure 5 gives the complete RBSOA characteristics.

## TYPICAL CHARACTERISTICS

Figure 7. DC Current Gain

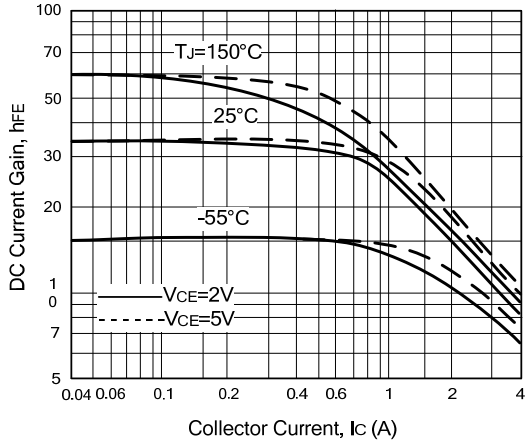

Figure 8. Collector Saturation Region

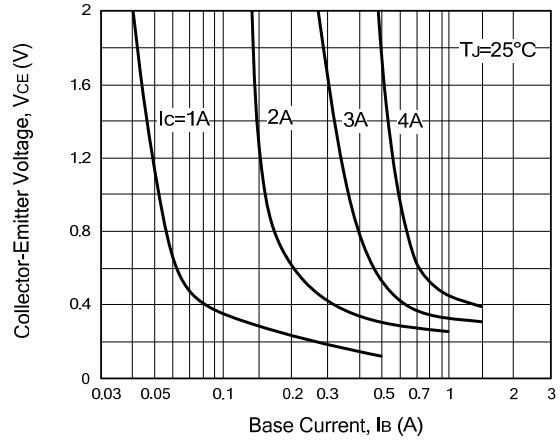

Figure 9. Base-Emitter Voltage

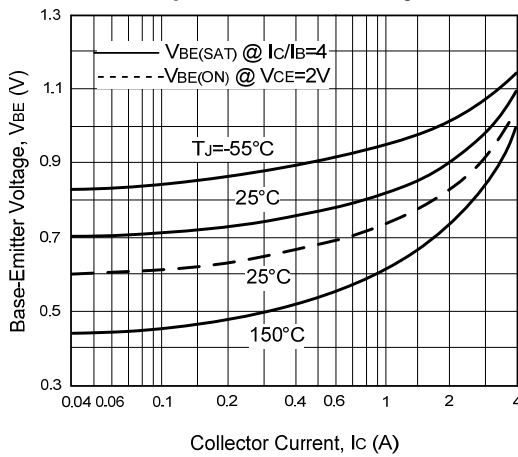

Figure 10. Collector-Emitter Saturation Voltage

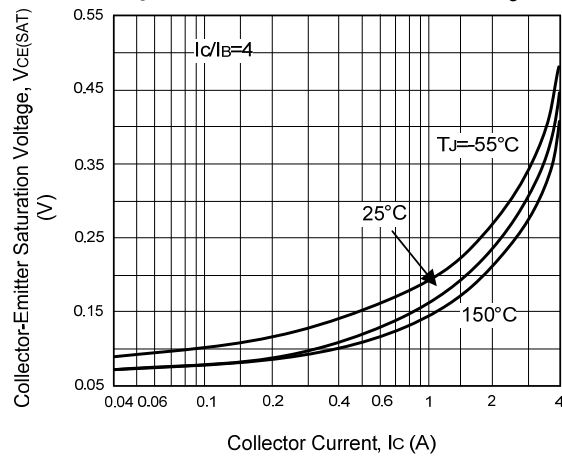

Figure 11. Collector Cutoff Region

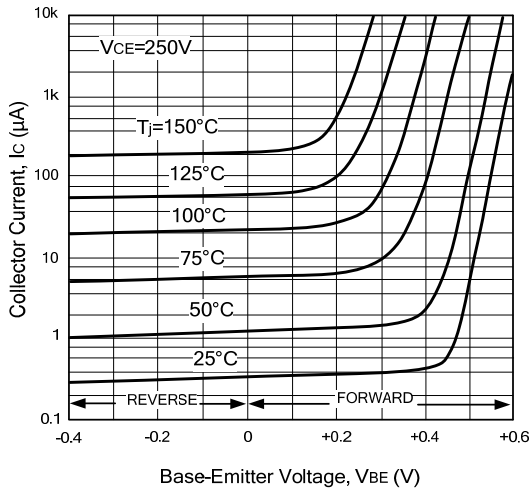
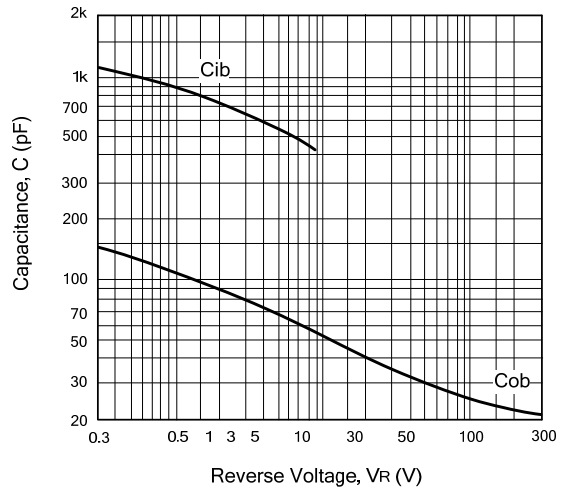

Figure 12. Capacitance



UTC assumes no responsibility for equipment failures that result from using products at values that exceed, even momentarily, rated values (such as maximum ratings, operating condition ranges, or other parameters) listed in products specifications of any and all UTC products described or contained herein. UTC products are not designed for use in life support appliances, devices or systems where malfunction of these products can be reasonably expected to result in personal injury. Reproduction in whole or in part is prohibited without the prior written consent of the copyright owner. The information presented in this document does not form part of any quotation or contract, is believed to be accurate and reliable and may be changed without notice.