

Standard Recovery Diodes (Hockey PUK Version), 650 A

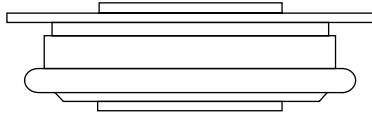

DO-200AA

FEATURES

- Wide current range
- High voltage ratings up to 3200 V
- High surge current capabilities
- Diffused junction
- Hockey PUK version
- Case style DO-200AA
- Lead (Pb)-free

**RoHS
COMPLIANT**
TYPICAL APPLICATIONS

- Converters
- Power supplies
- Machine tool controls
- High power drives
- Medium traction applications

PRODUCT SUMMARY

$I_{F(AV)}$	650 A
-------------	-------

MAJOR RATINGS AND CHARACTERISTICS

PARAMETER	TEST CONDITIONS	SD300C..C		UNITS
		04 TO 20	25 TO 32	
$I_{F(AV)}$		650	540	A
	T_{hs}	55	55	°C
$I_{F(RMS)}$		1150	995	A
	T_{hs}	25	25	°C
I_{FSM}	50 Hz	6050	6050	A
	60 Hz	6335	6335	
I^2t	50 Hz	183	183	kA ² s
	60 Hz	167	167	
V_{RRM}	Range	400 to 2000	2500 to 3200	V
T_J		- 40 to 180	- 40 to 150	°C

ELECTRICAL SPECIFICATIONS
VOLTAGE RATINGS

TYPE NUMBER	VOLTAGE CODE	V_{RRM} , MAXIMUM REPETITIVE PEAK REVERSE VOLTAGE V	V_{RSM} , MAXIMUM NON-REPETITIVE PEAK REVERSE VOLTAGE V	I_{RRM} MAXIMUM AT $T_J = T_J$ MAXIMUM mA
SD300C..C	04	400	500	15
	08	800	900	
	12	1200	1300	
	16	1600	1700	
	20	2000	2100	
	25	2500	2600	
	28	2800	2900	
	32	3200	3300	

FORWARD CONDUCTION						
PARAMETER	SYMBOL	TEST CONDITIONS		SD300C..C		UNITS
				04 TO 20	25 TO 32	
Maximum average forward current at heatsink temperature	$I_{F(AV)}$	180° conduction, half sine wave Double side (single side) cooled		650 (380)	540 (250)	A
				55 (85)	55 (85)	°C
Maximum RMS forward current	$I_{F(RMS)}$	25 °C heatsink temperature double side cooled		1150	995	
Maximum peak, one-cycle forward, non-repetitive surge current	I_{FSM}	t = 10 ms	No voltage reappplied	Sinusoidal half wave, initial $T_J = T_J$ maximum		A
		t = 8.3 ms				
		t = 10 ms	100 % V_{RRM} reappplied			
		t = 8.3 ms				
Maximum I^2t for fusing	I^2t	t = 10 ms	No voltage reappplied	183	kA ² s	
		t = 8.3 ms				
		t = 10 ms	100 % V_{RRM} reappplied	129		
		t = 8.3 ms		118		
Maximum $I^2\sqrt{t}$ for fusing	$I^2\sqrt{t}$	t = 0.1 to 10 ms, no voltage reappplied		1830	kA ² √s	
Low level value of threshold voltage	$V_{F(TO)1}$	$(16.7 \% \times \pi \times I_{F(AV)} < I < \pi \times I_{F(AV)})$, $T_J = T_J$ maximum		0.95	V	
High level value of threshold voltage	$V_{F(TO)2}$	$(I > \pi \times I_{F(AV)})$, $T_J = T_J$ maximum		1.00		
Low level values of forward slope resistance	r_{f1}	$(16.7 \% \times \pi \times I_{F(AV)} < I < \pi \times I_{F(AV)})$, $T_J = T_J$ maximum		0.75	mΩ	
High level values of forward slope resistance	r_{f2}	$(I > \pi \times I_{F(AV)})$, $T_J = T_J$ maximum		0.72		
Maximum forward voltage drop	V_{FM}	$I_{pk} = 1500$ A, $T_J = T_J$ maximum; $t_p = 10$ ms sinusoidal wave		2.08	V	

THERMAL AND MECHANICAL SPECIFICATIONS						
PARAMETER	SYMBOL	TEST CONDITIONS		SD300C..C		UNITS
				04 TO 20	25 TO 32	
Maximum operating temperature range	T_J			- 40 to 180	- 40 to 150	°C
Maximum storage temperature range	T_{Stg}			- 55 to 200		
Maximum thermal resistance, junction to heatsink	R_{thJ-hs}	DC operation single side cooled		0.163		K/W
		DC operation double side cooled		0.073		
Mounting force, ± 10 %				4900 (500)		N (kg)
Approximate weight				70		g
Case style		See dimensions - link at the end of datasheet		DO-200AA		

ΔR_{thJ-hs} CONDUCTION						
CONDUCTION ANGLE	SINUSOIDAL CONDUCTION		RECTANGULAR CONDUCTION		TEST CONDITIONS	UNITS
	SINGLE SIDE	DOUBLE SIDE	SINGLE SIDE	DOUBLE SIDE		
180°	0.017	0.017	0.011	0.012	$T_J = T_J$ maximum	K/W
120°	0.020	0.020	0.020	0.020		
90°	0.025	0.025	0.027	0.027		
60°	0.036	0.036	0.038	0.038		
30°	0.064	0.062	0.065	0.062		

Note

- The table above shows the increment of thermal resistance R_{thJ-hs} when devices operate at different conduction angles than DC

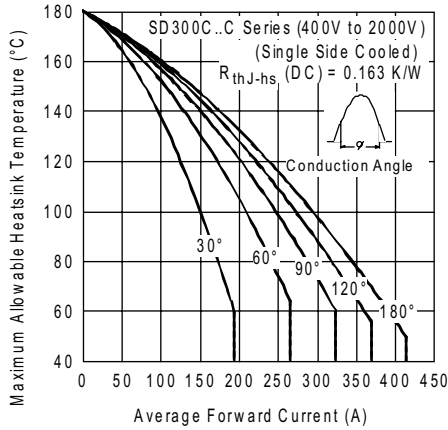

Fig. 1 - Current Ratings Characteristics

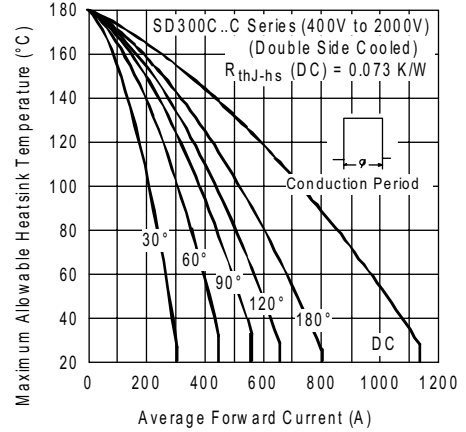

Fig. 4 - Current Ratings Characteristics

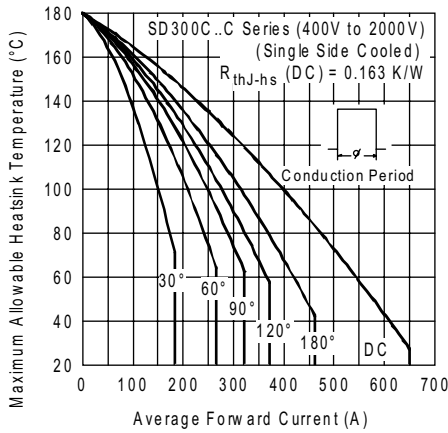

Fig. 2 - Current Ratings Characteristics

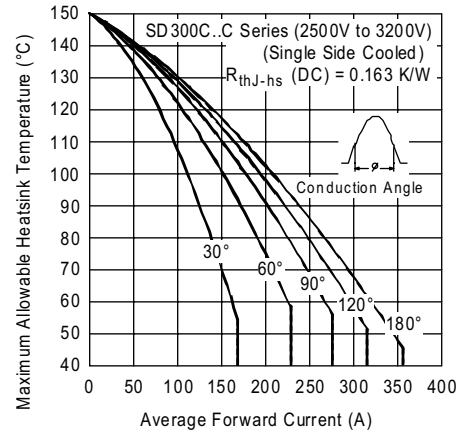

Fig. 5 - Current Ratings Characteristics

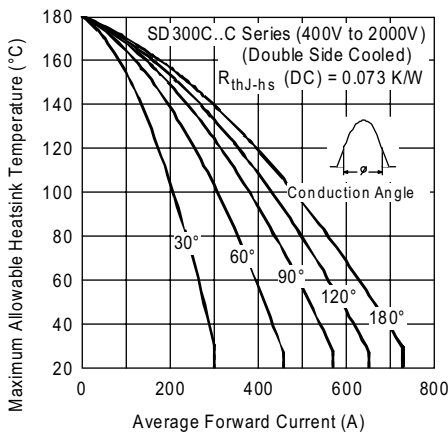

Fig. 3 - Current Ratings Characteristics

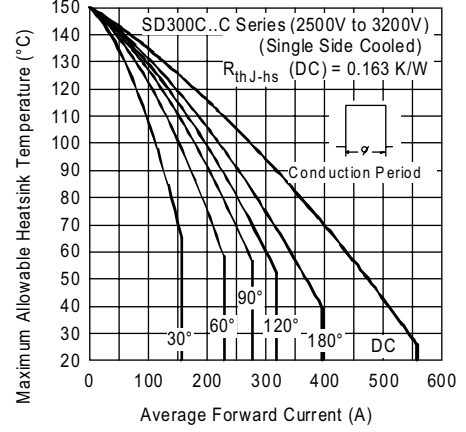

Fig. 6 - Current Ratings Characteristics

SD300C..C Series



Vishay High Power Products Standard Recovery Diodes
(Hockey PUK Version), 650 A

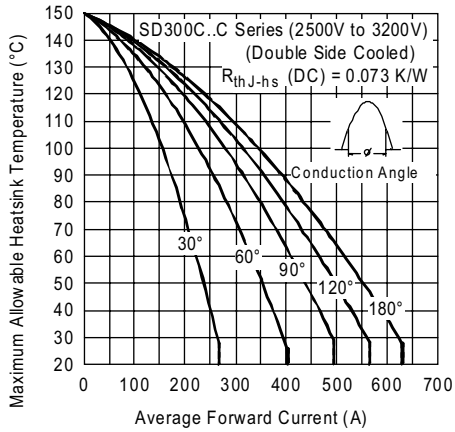

Fig. 7 - Current Ratings Characteristics

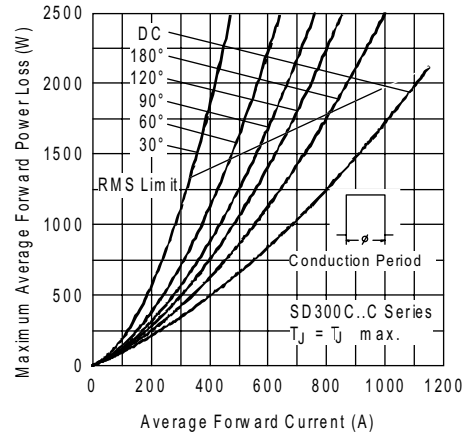

Fig. 10 - Forward Power Loss Characteristics

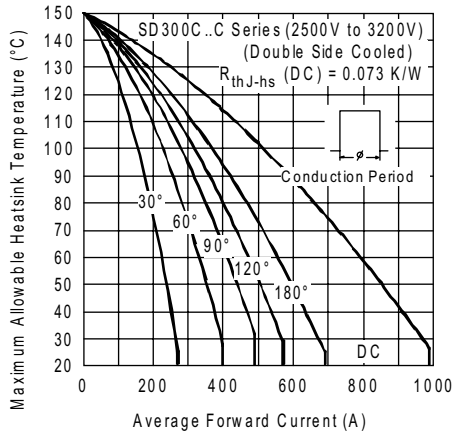

Fig. 8 - Current Ratings Characteristics

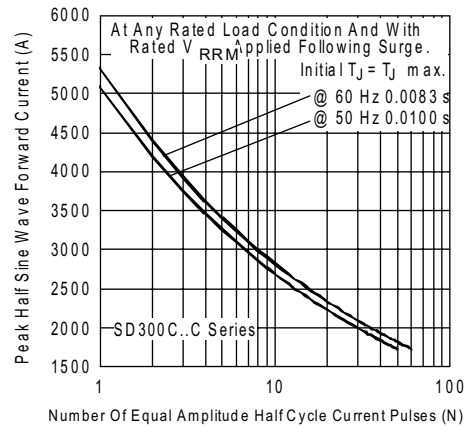

Fig. 11 - Maximum Non-Repetitive Surge Current Single and Double Side Cooled

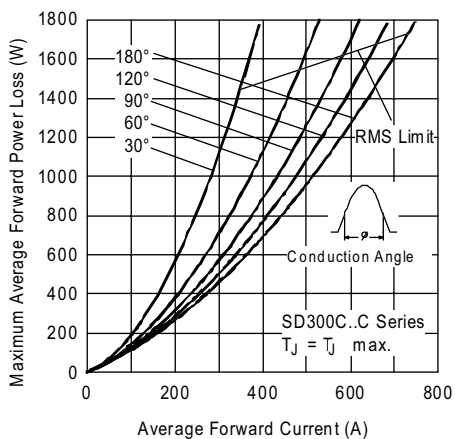

Fig. 9 - Forward Power Loss Characteristics

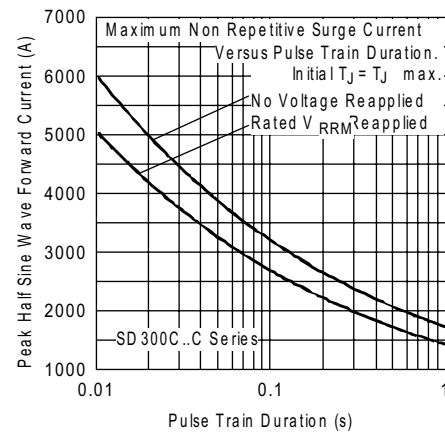

Fig. 12 - Maximum Non-Repetitive Surge Current Single and Double Side Cooled

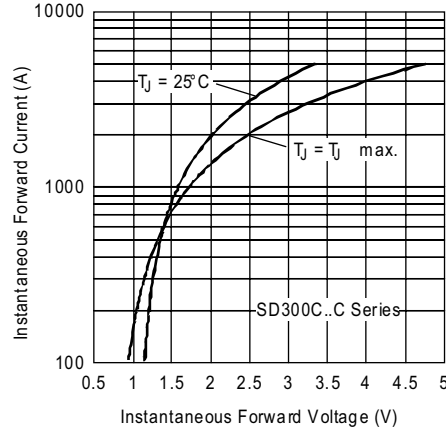

Fig. 13 - Forward Voltage Drop Characteristics

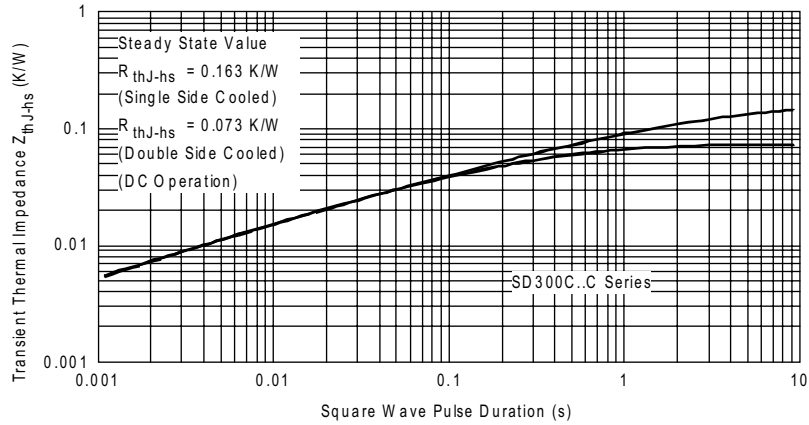

Fig. 14 - Thermal Impedance Z_{thJC} Characteristics

ORDERING INFORMATION TABLE

Device code	SD	30	0	C	32	C
	①	②	③	④	⑤	⑥
1	-	Diode				
2	-	Essential part number				
3	-	0 = Standard recovery				
4	-	C = Ceramic PUK				
5	-	Voltage code x 100 = V_{RRM} (see Voltage Ratings table)				
6	-	C = PUK case DO-200AA				

LINKS TO RELATED DOCUMENTS	
Dimensions	http://www.vishay.com/doc?95248

DO-200AA

DIMENSIONS in millimeters (inches)

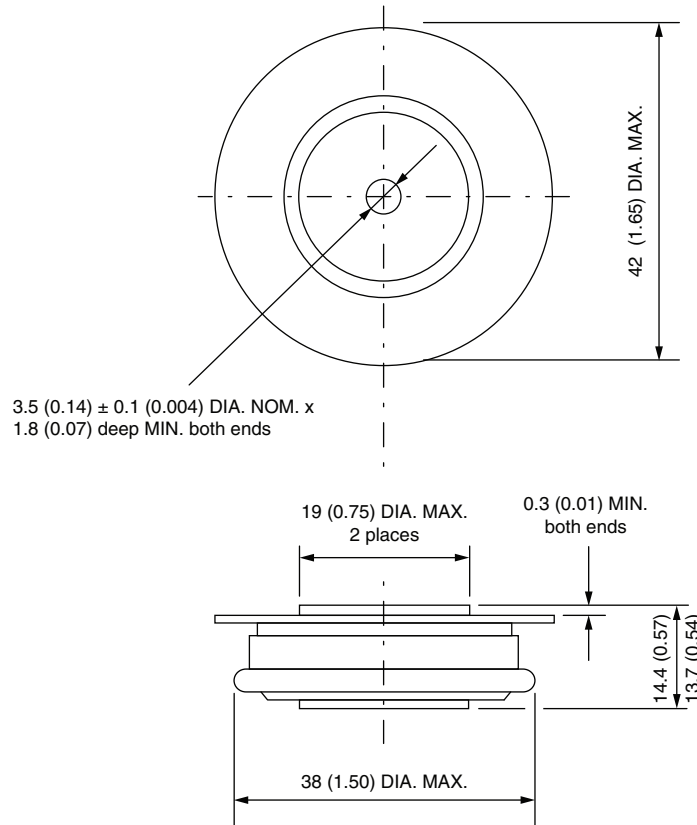

Quote between upper and lower pole pieces has to be considered after application of mounting force (see Thermal and Mechanical Specifications)



Disclaimer

ALL PRODUCT, PRODUCT SPECIFICATIONS AND DATA ARE SUBJECT TO CHANGE WITHOUT NOTICE TO IMPROVE RELIABILITY, FUNCTION OR DESIGN OR OTHERWISE.

Vishay Intertechnology, Inc., its affiliates, agents, and employees, and all persons acting on its or their behalf (collectively, "Vishay"), disclaim any and all liability for any errors, inaccuracies or incompleteness contained in any datasheet or in any other disclosure relating to any product.

Vishay makes no warranty, representation or guarantee regarding the suitability of the products for any particular purpose or the continuing production of any product. To the maximum extent permitted by applicable law, Vishay disclaims (i) any and all liability arising out of the application or use of any product, (ii) any and all liability, including without limitation special, consequential or incidental damages, and (iii) any and all implied warranties, including warranties of fitness for particular purpose, non-infringement and merchantability.

Statements regarding the suitability of products for certain types of applications are based on Vishay's knowledge of typical requirements that are often placed on Vishay products in generic applications. Such statements are not binding statements about the suitability of products for a particular application. It is the customer's responsibility to validate that a particular product with the properties described in the product specification is suitable for use in a particular application. Parameters provided in datasheets and/or specifications may vary in different applications and performance may vary over time. All operating parameters, including typical parameters, must be validated for each customer application by the customer's technical experts. Product specifications do not expand or otherwise modify Vishay's terms and conditions of purchase, including but not limited to the warranty expressed therein.

Except as expressly indicated in writing, Vishay products are not designed for use in medical, life-saving, or life-sustaining applications or for any other application in which the failure of the Vishay product could result in personal injury or death. Customers using or selling Vishay products not expressly indicated for use in such applications do so at their own risk and agree to fully indemnify and hold Vishay and its distributors harmless from and against any and all claims, liabilities, expenses and damages arising or resulting in connection with such use or sale, including attorneys fees, even if such claim alleges that Vishay or its distributor was negligent regarding the design or manufacture of the part. Please contact authorized Vishay personnel to obtain written terms and conditions regarding products designed for such applications.

No license, express or implied, by estoppel or otherwise, to any intellectual property rights is granted by this document or by any conduct of Vishay. Product names and markings noted herein may be trademarks of their respective owners.

Material Category Policy

Vishay Intertechnology, Inc. hereby certifies that all its products that are identified as RoHS-Compliant fulfill the definitions and restrictions defined under Directive 2011/65/EU of The European Parliament and of the Council of June 8, 2011 on the restriction of the use of certain hazardous substances in electrical and electronic equipment (EEE) - recast, unless otherwise specified as non-compliant.

Please note that some Vishay documentation may still make reference to RoHS Directive 2002/95/EC. We confirm that all the products identified as being compliant to Directive 2002/95/EC conform to Directive 2011/65/EU.