

PLEASE CHECK WWW.MOLEX.COM FOR LATEST PART INFORMATION

Part Number: [0472738001](#)
Status: **Active**
Description: 2.54mm (.100") Pitch SIM Card Holder, 6 Circuits, SMT, 0.25µm (10µ") Gold (Au) Plating, with Staggered Solder Tabs, Housing Height 2.70mm (.106"), Lead Free

Documents:

[Drawing \(PDF\)](#) [RoHS Certificate of Compliance \(PDF\)](#)
[Product Specification PS-47273-001 \(PDF\)](#)

General

Product Family	Memory Card Sockets
Series	47273
Button Type	N/A
Component Type	Card Holder (Host)
Product Name	SIM
Type	N/A
Physical	
Card Detection Switch	N/A
Circuits (Loaded)	6
Circuits (maximum)	6
Color - Resin	Black
Durability (mating cycles max)	5,000
Ejector Button Side	No Ejector Button Present
Entry Angle	Vertical (Top Entry)
Keying to Mating Part	Yes
Material - Metal	Phosphor Bronze
Material - Plating Mating	Gold
Material - Plating Termination	Gold
Material - Resin	High Temperature Thermoplastic
PCB Locator	No
PCB Mounting Side	Normal
PCB Retention	Yes
Packaging Type	Embossed Tape on Reel
Pitch - Mating Interface (in)	0.100 In
Pitch - Mating Interface (mm)	2.54 mm
Pitch - Term. Interface (in)	0.100 In
Pitch - Term. Interface (mm)	2.54 mm
Plating min: Mating (µin)	10
Plating min: Mating (µm)	0.25
Plating min: Termination (µin)	2
Plating min: Termination (µm)	0.05
Ports	1
Temperature Range - Operating	-40°C to +85°C
Termination Interface: Style	Surface Mount

Electrical

Current - Maximum per Contact	0.5A
Shielded	No
Voltage - Maximum	5V AC (RMS)/DC

Solder Process Data

Duration at Max. Process Temperature (seconds)	3
Lead-free Process Capability	Reflow Capable (SMT only)
Max. Cycles at Max. Process Temperature	3
Process Temperature max. C	250

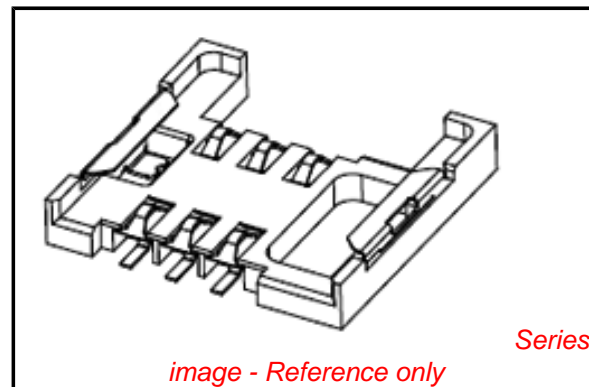

EU RoHS

**ELV and RoHS
Compliant**
**REACH SVHC
Contains SVHC: No**
**Halogen-Free
Status**

China RoHS



**Need more information on product
environmental compliance?**

Email productcompliance@molex.com
 For a multiple part number RoHS Certificate of Compliance, [click here](#)

Please visit the [Contact Us](#) section for any non-product compliance questions.

Search Parts in this Series

[47273Series](#)

Mates With

Standard SIM Card

Material Info

Reference - Drawing Numbers

Product Specification

PS-47273-001

Sales Drawing

SD-47273-801

This document was generated on 04/19/2010

PLEASE CHECK WWW.MOLEX.COM FOR LATEST PART INFORMATION

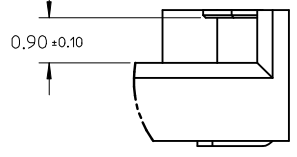
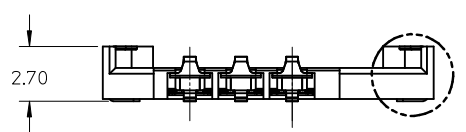
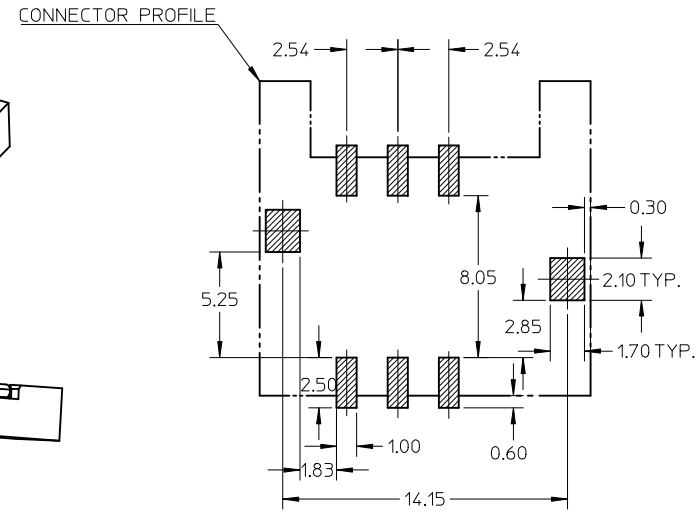
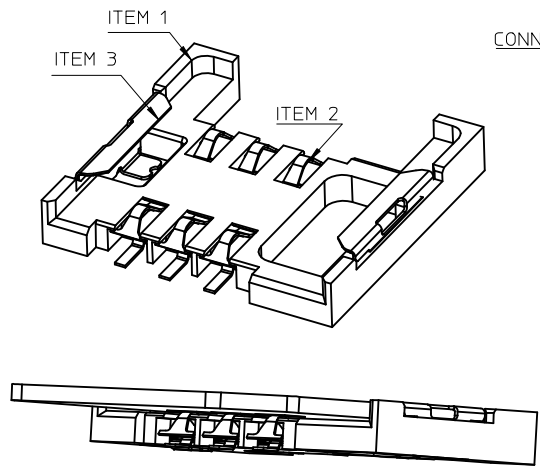
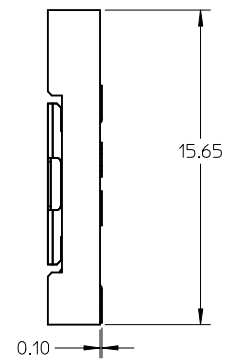
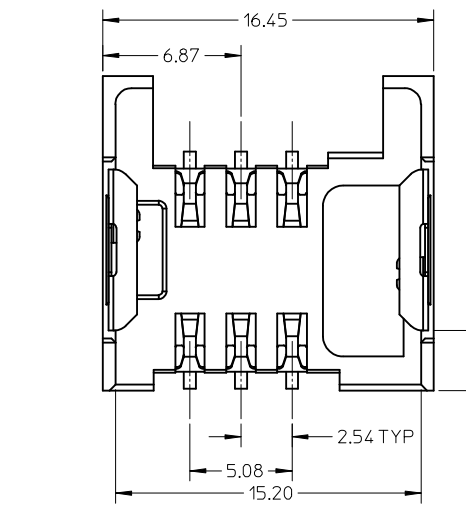

DETAIL1

DETAIL1

NOTES:

1.MATERIAL:

HOUSING: LCP, GLASS-FILLED, UL 94V-0, COLOR ,BLACK.
 TERMINAL: 0.12MM PHOSPHOR BRONZE.
 SHELL: STAINLESS STEEL.

2.FINISH:

TERMINAL CONTACT AREA: 10μ² GOLD PLATING OVERALL 1.25 MICRON NICKEL MIN.
 TERMINAL SOLDER AREA: GOLD FLASH OVERALL 1.25 MICRON NICKEL MIN.
 SHELL: GOLD FLASH OVER SOLDERING PAD, 2.0 MICRON NICKEL MIN. OVERALL

3.COPLANARITY: 0.1MM MAX AMONG SOLDER TAILS AND FITTING NAILS.

4.PRODUCT SPECIFICATION: PS-47273-001.

5.PRODUCT COMPLIANT TO ROHS DIRECTIVE 2002/95/EC
 AND ELV DIRECTIVE 2000/53/EC

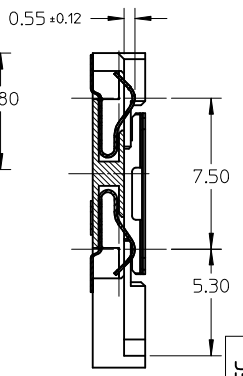
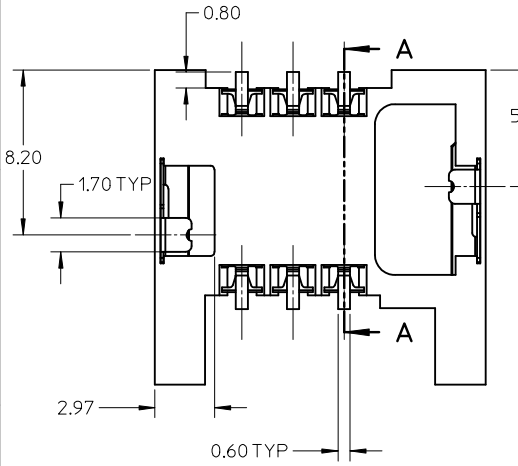

SECTION A-A

ITEM	NAME	MATERIAL NO.
1	HOUSING	472730002
2	TERMINAL	472738003
3	SHELL	472730004

UPDATED PLATING SPEC.	EC NO:	2009/09/01
	DRW:LL1010	2009/09/01
	CHKD:	2009/09/13
	APPR:MFDENG	2009/09/13
REV	A	

QUALITY SYMBOLS	DESCRIPTION
▽=0	
⊕=0	

GENERAL TOLERANCES (UNLESS SPECIFIED)

	mm	INCH
4 PLACES	± ---	± ---
3 PLACES	± ---	± ---
2 PLACES	± 0.2	± ---
1 PLACE	± ---	± ---

DRAFT WHERE APPLICABLE
 MUST REMAIN
 WITHIN DIMENSIONS

DIMENSION STYLE
 MM ONLY

DRAWN BY	DATE
OYANG	2005-08-31
CHECKED BY	DATE
Y. J WU	2005-08-31
APPROVED BY	DATE
VINCENT	2005-08-31

MATERIAL NO.
472738001

SCALE
 4:1

DESIGN UNITS
 METRIC

THIRD ANGLE PROJECTION

TITLE
**SIM CARD CONNECTOR
 SALES DRAWING**

MOLEX INCORPORATED

DOCUMENT NO. **SD-47273-801** SHEET NO. **1 OF 1**

THIS DRAWING CONTAINS INFORMATION THAT IS PROPRIETARY TO MOLEX INCORPORATED AND SHOULD NOT BE USED WITHOUT WRITTEN PERMISSION