

Military 24-Pin PAL Devices

Features

- Registers with feedback
- Programmable three-state outputs
- Security fuse prevents duplication of logic
- Variety of speed/power options available in same architecture
- Register preload to aid in device testing
- Power-up reset to logical high
- Programmable output polarity
- Product term sharing
- Programmable register or combinatorial outputs
- Dual feedback allows buried state registers or input registers (PAL32VX10)
- Programmable flip-flops allow J-K, S-R, T or D types (PAL32VX10)
- Asynchronous preset/synchronous reset, synchronous preset/asynchronous reset (PAL32VX10)
- Through-hole or surface mount device packaging
- Neutron fluence (permanent damage): 1×10^{13} N/cm²
- Dose rate (transient upset) junction isolated Bipolar processes: 2×10^{10} RADs (Si) per sec recovered in 50 to 70 μ s from a 1 μ s pulse

Benefits

- Instant prototyping/zero NRE charge
- Low-cost programmable replacement for TTL logic
- Reduces inventory by reducing chip count
- Programmed on standard PROM/PAL device programmers
- Several software programs available to assist in creating bit pattern designs

Applications

- High speed graphic controllers
- High speed computers
- High frequency state machines
- High frequency counters
- Microprocessor clock generation and interface logic
- DMA controllers
- Asynchronous bus interface
- CRT controllers
- Peripheral/handshaking interface
- Interrupt controllers
- Memory mapped I/O (PAL8L14A)
- Microprocessor decoder (PAL8L14A)

24-Pin PAL Device Speed vs. Power

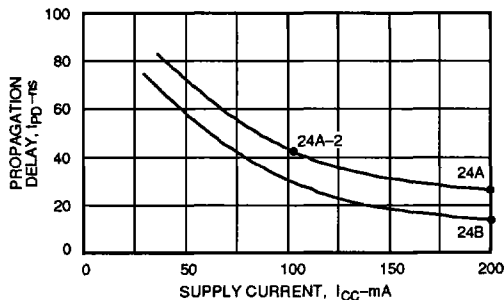

503 144

5

Military 24-Pin PAL Devices

Register Preload

Register preload is an aid to functional testing, which is usually performed after the device is programmed but before it is installed on the circuit board. Using register preload, the register of a device can be "preloaded" to any desired state value. This is particularly useful in applications where the output is fed back into the array as an input, since it may take many state transitions to reach a desired state in the output register. Register preload also allows the user to set the device to an "illegal" state which cannot be reached through normal state transitions, in order to test for proper recovery.

Power-Up Reset

Another added testability feature found on these Series is power-up reset. Power-up reset makes system initialization simple; registers are reset to logic 0 at power-up, thus all outputs are set to logic 1.

The table below is a brief summary of our current devices that do have register preload and/or power-up reset.

Devices with Register Preload and Power-Up Reset

| DEVICE FAMILY | REGISTER PRELOAD | POWER-UP RESET |
|----------------------------|------------------|----------------|
| Exclusive OR 24XA | YES | YES |
| Shared Product terms 24RS | YES | YES |
| Asynchronous 24RA | YES | YES |
| Varied Product terms 24VX* | YES | YES |

* The PAL32VX10/10A has power-up preset; registers are set to logical 1 on power up.

Military 24-Pin PAL Device Pinouts

12L10

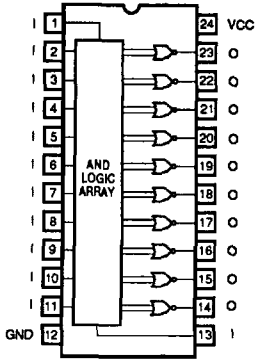

CERDIP CERPACK

12L10

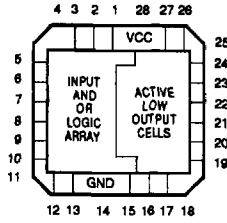

LEADLESS CHIP CARRIER

14L8

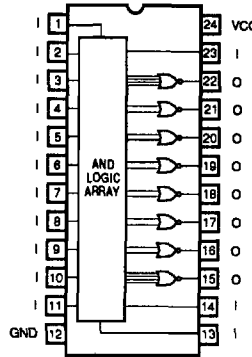

CERDIP CERPACK

14L8

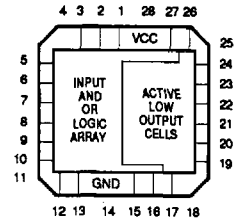

LEADLESS CHIP CARRIER

16L6

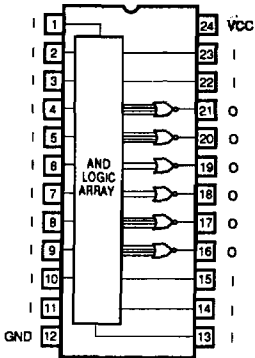

CERDIP CERPACK

16L6

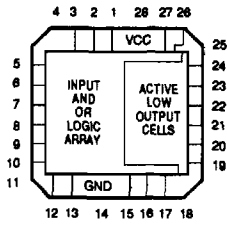

LEADLESS CHIP CARRIER

18L4

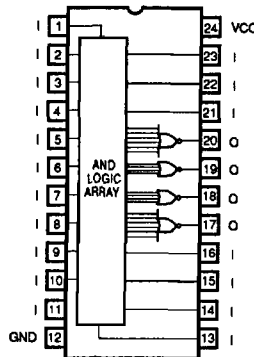

CERDIP CERPACK

18L4

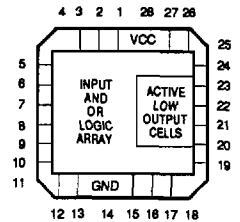

LEADLESS CHIP CARRIER

20L2

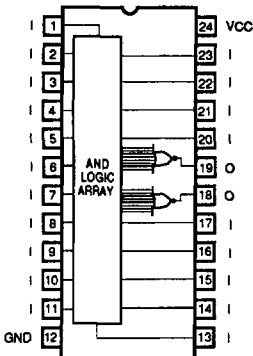

CERDIP CERPACK

20L2

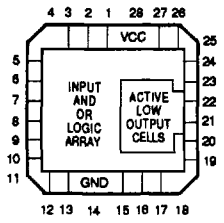

LEADLESS CHIP CARRIER

20C1

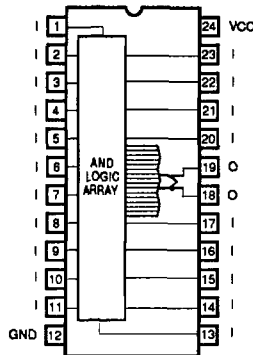

CERDIP CERPACK

20C1

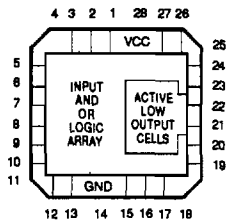

LEADLESS CHIP CARRIER

Military 24-Pin PAL Device Pinouts

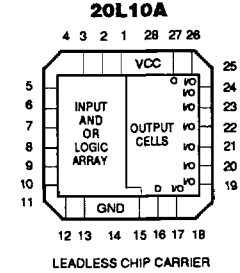
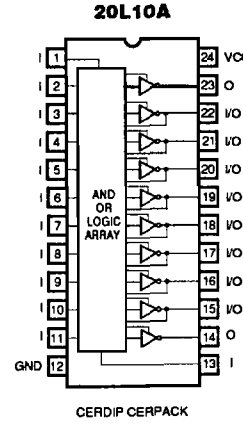
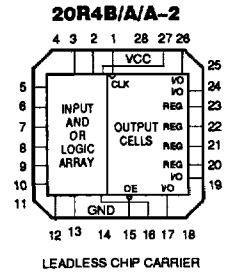
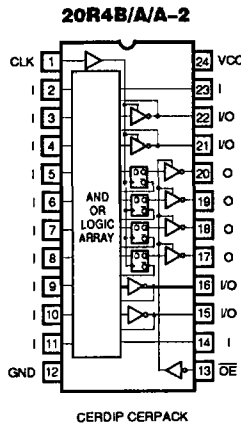
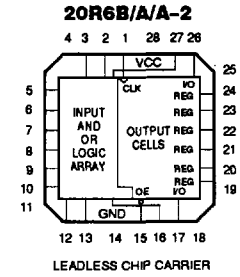
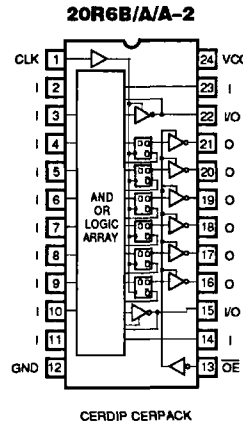
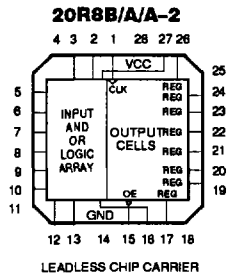
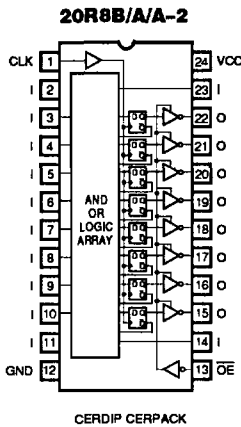
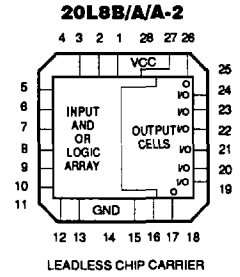
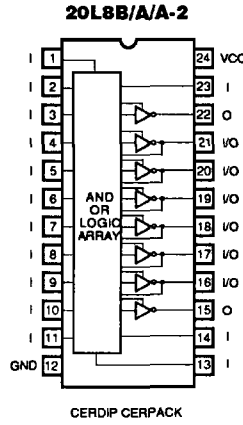
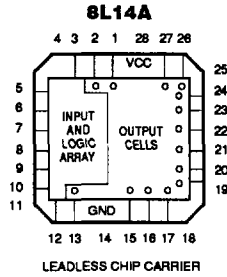
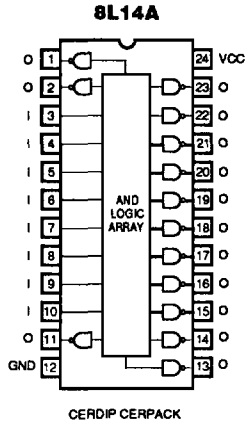

Military 24-Pin PAL Device Pinouts

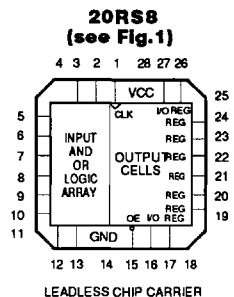
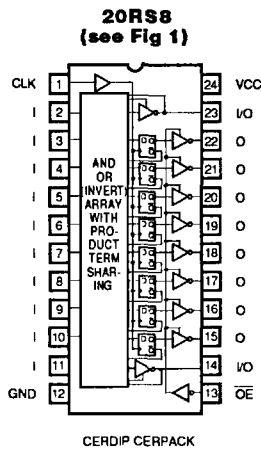
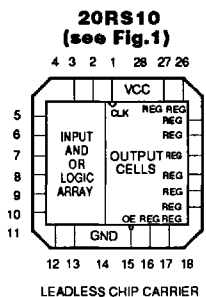
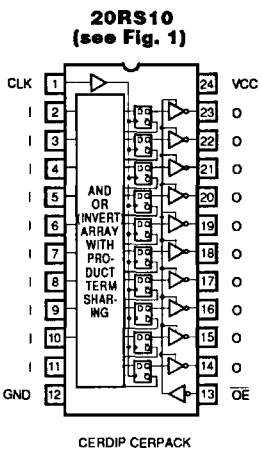
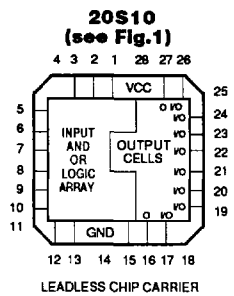
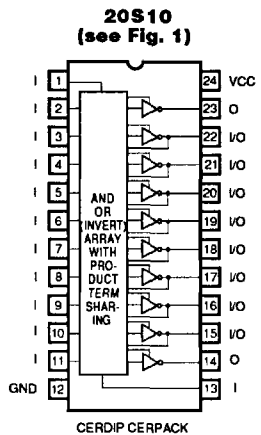
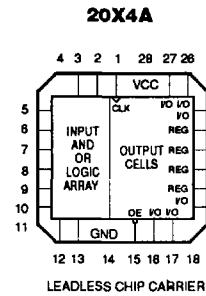
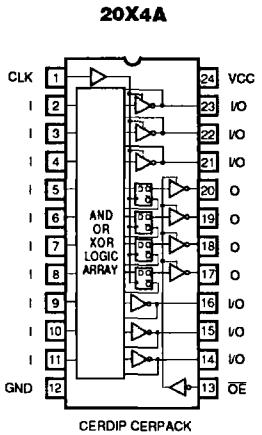
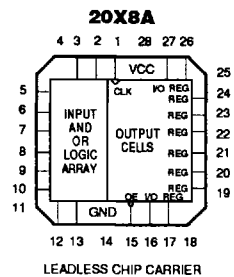
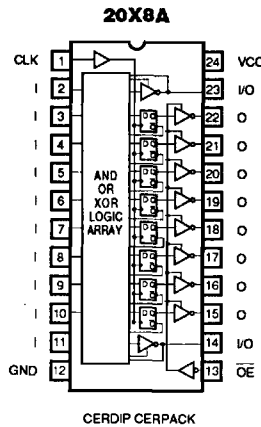
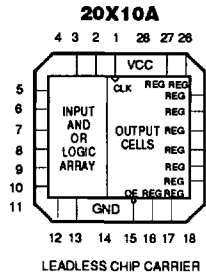
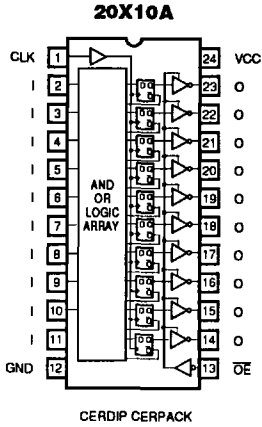

Military 24-Pin PAL Device Pinouts

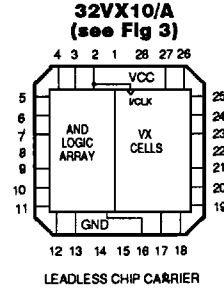
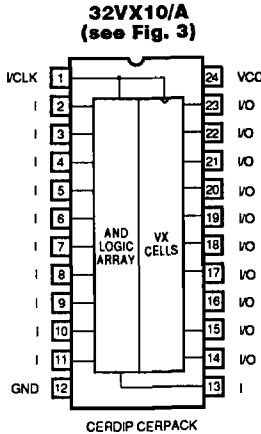
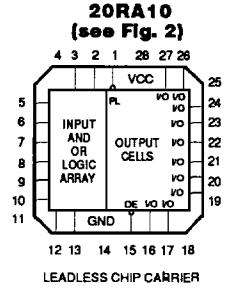
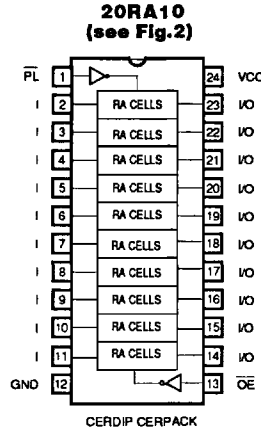
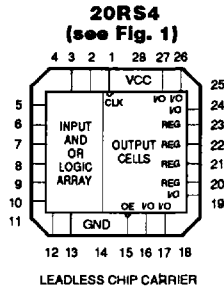
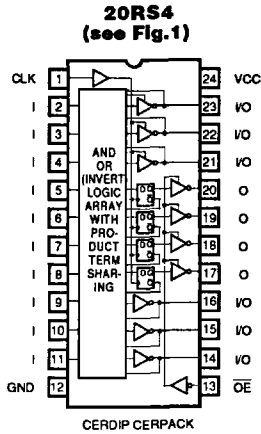

503 181

Military PAL20S10, 20RS10, 20RS8, 20RS4 Series

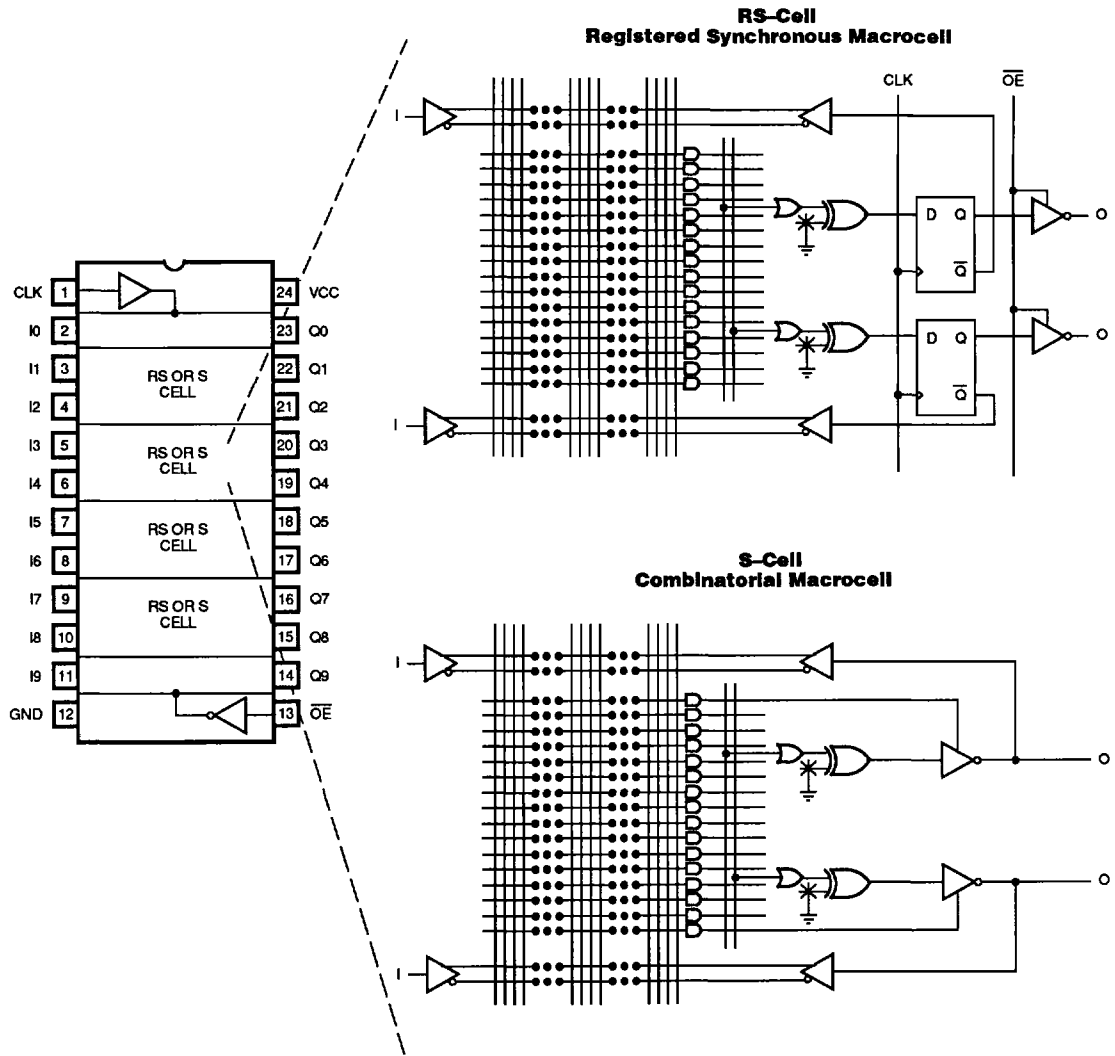

Figure 1.

503 187

Military PAL20RA10 Device

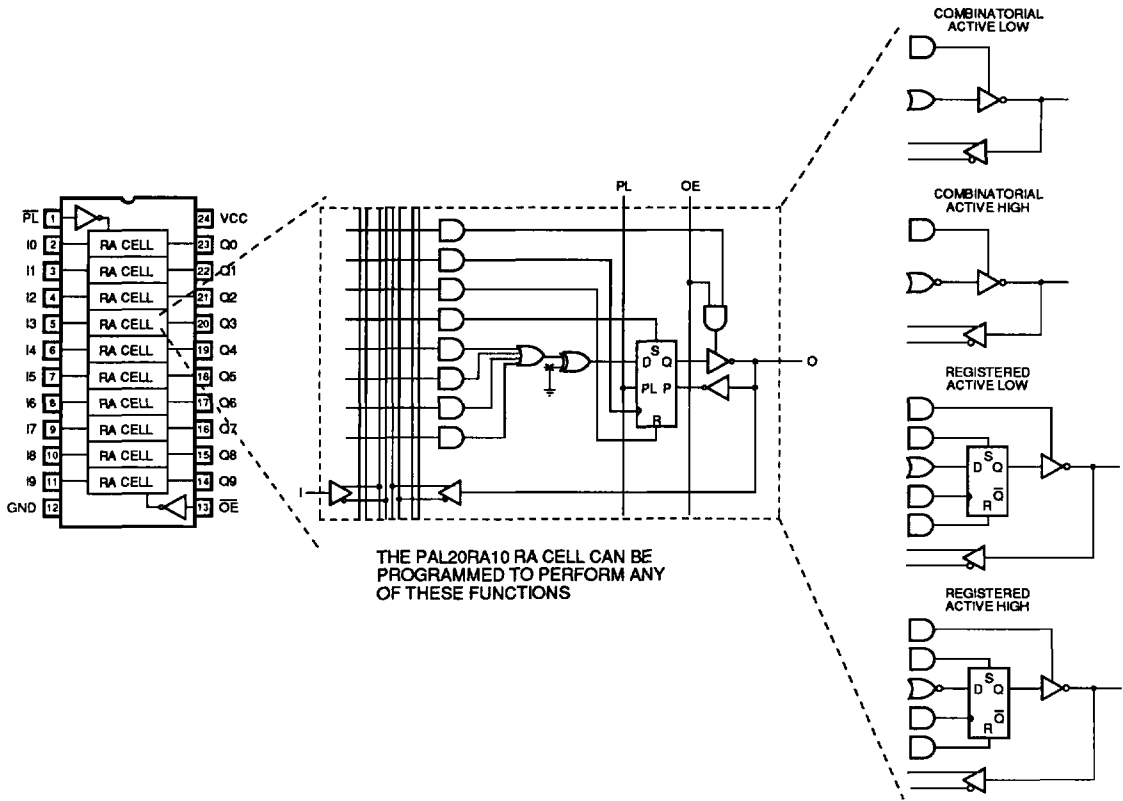
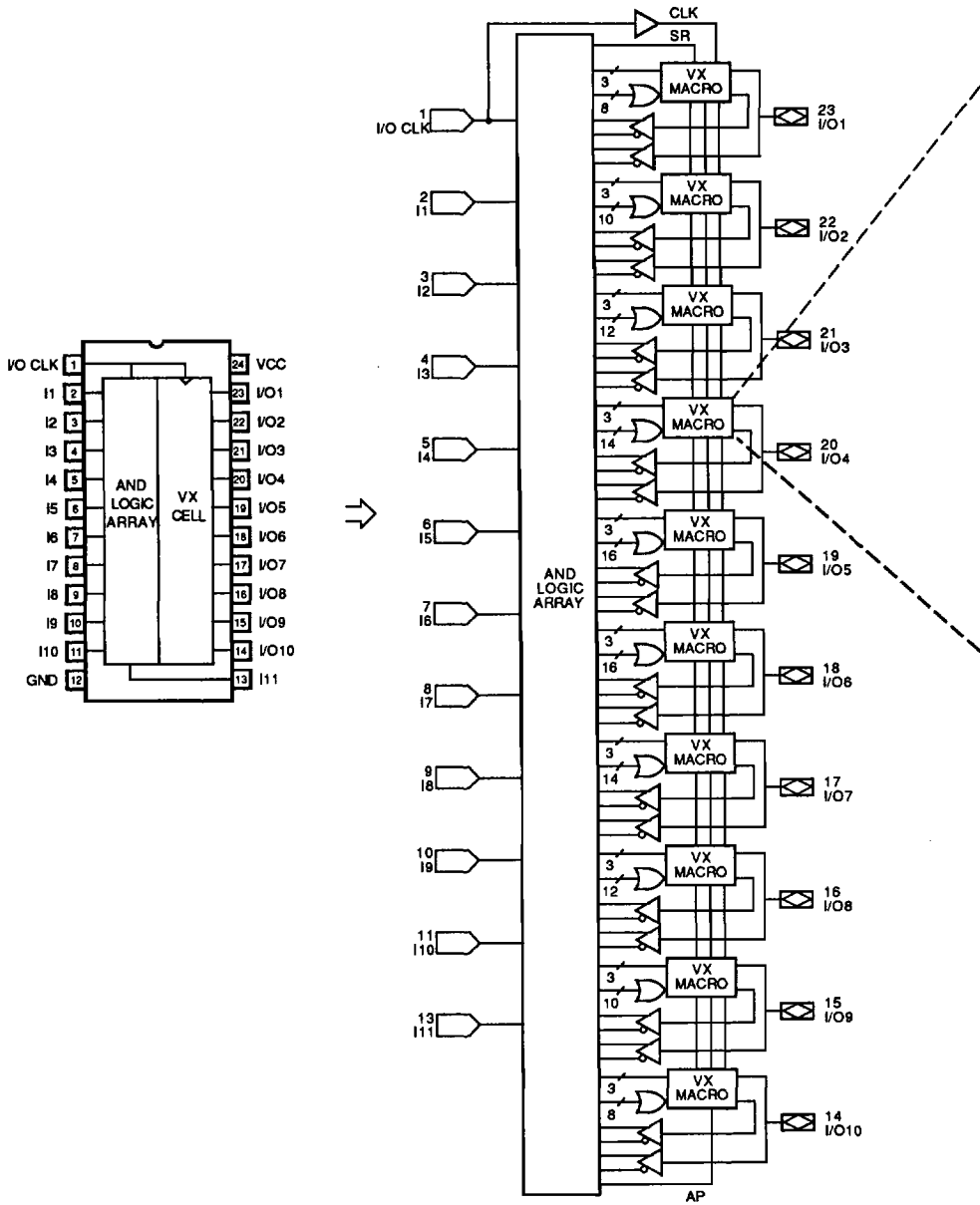

Figure 2.

Military PAL32VX10 Device



5

Figure 3.

503 191

Military 24-Pin PAL Devices

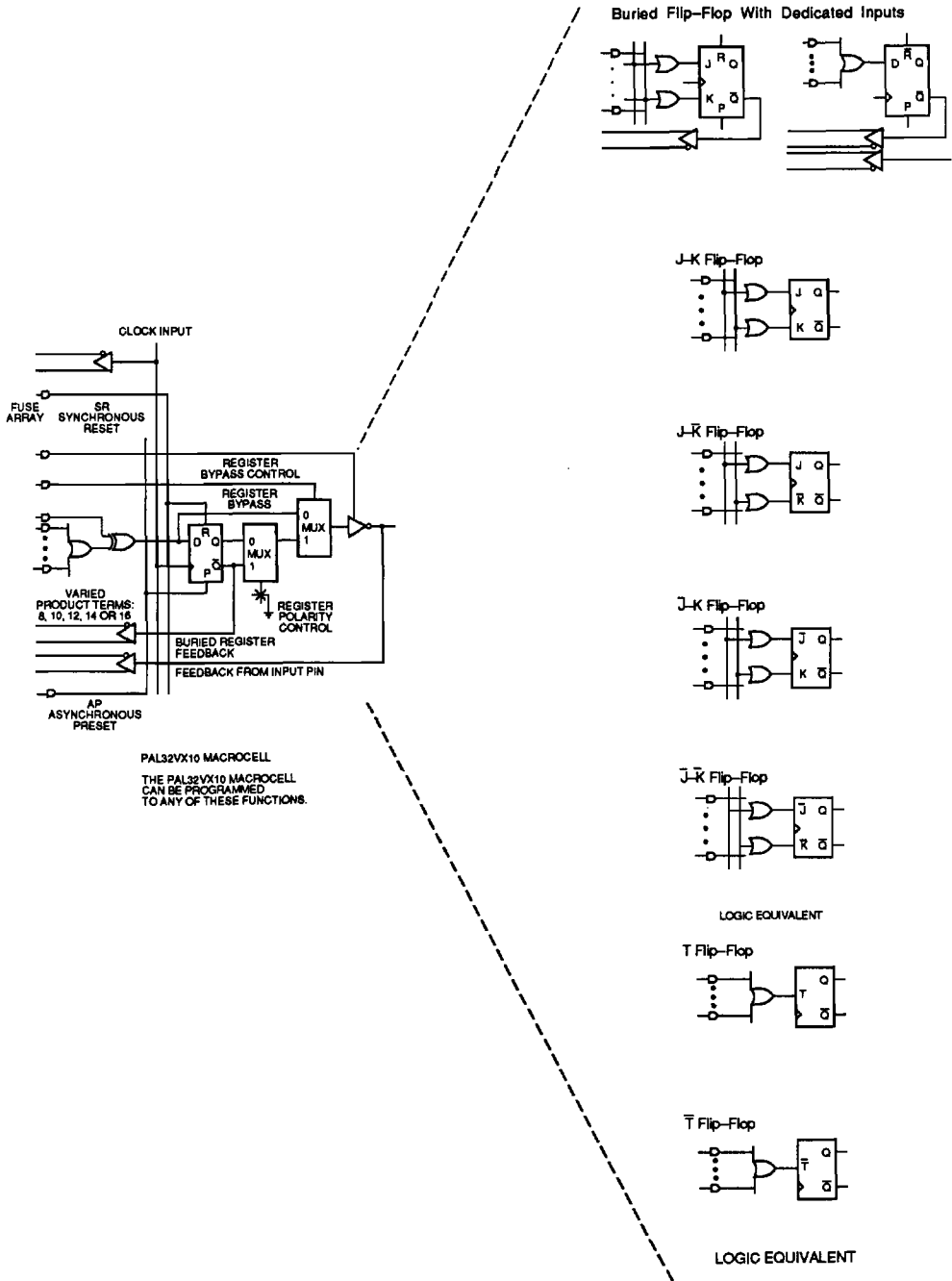

503 192

Figure 3. (Cont'd.)

Military 24-Pin PAL Devices

Absolute Maximum Ratings

| | Operating |
|---|--|
| Supply voltage V_{cc} | -0.5 V to 7 V |
| Input voltage | -1.5 V to 5.5 V |
| Off-state output voltage | 5.5 V |
| Storage temperature | -65°C to +150°C |
| Maximum junction temperature (T_j) | 175°C |
| Lead temperature (soldering, 10 sec max) | 300°C |
| Maximum current density 5×10^{-5} A/cm ² per Mil-M-38510 | $< 5 \times 10^{-5}$ A/cm ² |
| Maximum $\theta_{jc} = 28^\circ\text{C/W}$ for cerdips per Mil-M-38510 | $< 28^\circ\text{C/W}$ |
| Maximum $\theta_{jc} = 22^\circ\text{C/W}$ for flatpacks per Mil-M-38510 | $< 22^\circ\text{C/W}$ |
| Maximum $\theta_{jc} = 20^\circ\text{C/W}$ for leadless chip carriers per Mil-M-38510 | $< 20^\circ\text{C/W}$ |

Military Standard 24-Pin PAL Series

PAL12L10, 14L8, 16L6, 18L4, 20L2, 20C1

Can be purchased to military drawing 5962-86804, latest revision in effect.

Operating Conditions

| SYMBOL | PARAMETER | MIN | MAX | UNIT |
|------------|--------------------------------|------|------|------|
| V_{CC} | Supply voltage | 4.5 | 5.5 | V |
| T_A | Operating free-air temperature | -55 | | °C |
| T_C | Operating case temperature | | 125 | °C |
| V_{IL}^* | Low-level input voltage | | ≤0.8 | V |
| V_{IH}^* | High-level input voltage | ≥2.0 | | V |

Note: Virgin array verify of unprogrammed PAL device is performed at 25°C only.

* These are absolute voltages with respect to the ground pin on the device and include all overshoots due to system and/or tester noise.

Electrical Characteristics Over Operating Conditions

| SYMBOL | PARAMETER | TEST CONDITIONS | | MIN | MAX | UNIT |
|------------|------------------------------|------------------------|--------------------------|-----|-------|------|
| V_{IC} | Input clamp voltage | $V_{CC} = \text{MIN}$ | $I_I = -18 \text{ mA}$ | | -1.5 | V |
| I_{IL} | Low-level input current | $V_{CC} = \text{MAX}$ | $V_I = 0.4 \text{ V}$ | | -0.25 | mA |
| I_{IH} | High-level input current | $V_{CC} = \text{MAX}$ | $V_I = 2.4 \text{ V}$ | | 25 | μA |
| I_I | Maximum input current | $V_{CC} = \text{MAX}$ | $V_I = 5.5 \text{ V}$ | | 1 | mA |
| V_{OL} | Low-level output voltage | $V_{CC} = \text{MIN}$ | $I_{OL} = 8 \text{ mA}$ | | 0.5 | V |
| V_{OH} | High-level output voltage | $V_{CC} = \text{MIN}$ | $I_{OH} = -2 \text{ mA}$ | 2.4 | | V |
| I_{OS}^* | Output short-circuit current | $V_{CC} = 5 \text{ V}$ | $V_O = 0.5 \text{ V}$ | -30 | -130 | mA |
| I_{CC} | Supply current | $V_{CC} = \text{MAX}$ | | | 100 | mA |

*Not more than one output should be shorted at a time and duration of the short circuit should not exceed one second.

Switching Characteristics Over Operating Conditions

| SYMBOL | PARAMETER | TEST CONDITIONS | MIN | MAX | UNIT |
|----------|-----------------------------|---|-----|-----|------|
| t_{PD} | Input or feedback to output | $R_1 = 560 \Omega$ $R_2 = 1.1 \text{ K}\Omega$ | | 45 | ns |

Programmed devices conform to Mil-Std-883, Method 5005, Group A, Subgroups 1, 2, 3, 7, 8, 9, 10 and 11.

Military Decoder 24-Pin PAL Device

PAL8L14A

Operating Conditions

| SYMBOL | PARAMETER | MIN | MAX | UNIT |
|------------|--------------------------------|------|------|------|
| V_{CC} | Supply voltage | 4.5 | 5.5 | V |
| T_A | Operating free-air temperature | -55 | | °C |
| T_C | Operating case temperature | | 125 | °C |
| V_{IL}^* | Low-level input voltage | | ≤0.8 | V |
| V_{IH}^* | High-level input voltage | ≥2.0 | | V |

Note: Virgin array verify of unprogrammed PAL device is performed at 25°C only.

* These are absolute voltages with respect to the ground pin on the device and include all overshoots due to system and/or tester noise.

Electrical Characteristics Over Operating Conditions

| SYMBOL | PARAMETER | TEST CONDITIONS | | MIN | MAX | UNIT |
|------------|------------------------------|------------------------|--------------------------|-----|-------|------|
| V_{IC} | Input clamp voltage | $V_{CC} = \text{MIN}$ | $I_I = -18 \text{ mA}$ | | -1.5 | V |
| I_{IL} | Low-level input current | $V_{CC} = \text{MAX}$ | $V_I = 0.4 \text{ V}$ | | -0.25 | mA |
| I_{IH} | High-level input current | $V_{CC} = \text{MAX}$ | $V_I = 2.4 \text{ V}$ | | 25 | μA |
| I_I | Maximum input current | $V_{CC} = \text{MAX}$ | $V_I = 5.5 \text{ V}$ | | 1 | mA |
| V_{OL} | Low-level output voltage | $V_{CC} = \text{MIN}$ | $I_{OL} = 8 \text{ mA}$ | | 0.5 | V |
| V_{OH} | High-level output voltage | $V_{CC} = \text{MIN}$ | $I_{OH} = -2 \text{ mA}$ | 2.4 | | V |
| I_{OS}^* | Output short-circuit current | $V_{CC} = 5 \text{ V}$ | $V_O = 0.5 \text{ V}$ | -30 | -130 | mA |
| I_{CC} | Supply current | $V_{CC} = \text{MAX}$ | | | 100 | mA |

*Not more than one output should be shorted at a time and duration of the short circuit should not exceed one second.

5

Switching Characteristics Over Operating Conditions

| SYMBOL | PARAMETER | TEST CONDITIONS | MIN | MAX | UNIT |
|----------|-----------------------------------|---|-----|-----|------|
| t_{PD} | Input to output propagation delay | $R_1 = 560 \Omega$ $R_2 = 1.1 \text{ K}\Omega$ | | 30 | ns |

Programmed devices conform to Mil-Std-883, Method 5005, Group A, Subgroups 1, 2, 3, 7, 8, 9, 10 and 11.

Military Very High Speed 24-Pin PAL Series

PAL20L8B, 20R8B, 20R6B, 20R4B

Can be purchased to standard military drawing 5962-87671, latest revision in effect.

Military High Speed 24-Pin PAL Series

PAL20L8A, 20R8A, 20R6A, 20R4A

Can be purchased to standard military drawing 84129, latest revision in effect.

Operating Conditions

| SYMBOL | PARAMETER | 24 B | | 24 A | | UNIT |
|--------------------|---|----------------|-----|------|-----|------|
| | | MIN | MAX | MIN | MAX | |
| V_{CC} | Supply voltage | 4.5 | 5.5 | 4.5 | 5.5 | V |
| T_A | Operating free-air temperature | -55 | | -55 | | °C |
| T_C | Operating case temperature | 125 | | 125 | | °C |
| t_w^{\dagger} | Width of clock (except 20L8) | Low, t_{wl} | 12 | 20 | | ns |
| | | High, t_{wh} | 12 | 20 | | ns |
| t_{su}^{\dagger} | Set up time from input or feedback to clock (except 20L8) | 20 | | 30 | | ns |
| t_h^{\dagger} | Hold time | 0 | | 0 | | ns |
| V_{IL}^* | Low-level input voltage | ≤0.8 | | ≤0.8 | | V |
| V_{IH}^* | High-level input voltage | ≥2.0 | | ≥2.0 | | V |

Note: Virgin array verify of unprogrammed PAL device is performed at 25°C only.

* These are absolute voltages with respect to the ground pin on the device and include all overshoots due to system and/or tester noise.

† These are device set-up conditions, which are measured during initial qualification, and are not directly tested.

Electrical Characteristics Over Operating Conditions

| SYMBOL | PARAMETER | TEST CONDITIONS | | MIN | MAX | UNIT |
|---------------|------------------------------|-------------------------|-------------------------|-----|-------|------|
| V_{IC} | Input clamp voltage | $V_{CC} = 4.5\text{ V}$ | $I_I = -18\text{ mA}$ | | -1.5 | V |
| I_{IL}^* | Low-level input current | $V_{CC} = 5.5\text{ V}$ | $V_I = 0.4\text{ V}$ | | -0.25 | mA |
| I_{IH}^* | High-level input current | $V_{CC} = 5.5\text{ V}$ | $V_I = 2.4\text{ V}$ | | 25 | μA |
| I_I | Maximum input current | $V_{CC} = 5.5\text{ V}$ | $V_I = 5.5\text{ V}$ | | 1.0 | mA |
| V_{OL} | Low-level output voltage | $V_{CC} = 4.5\text{ V}$ | $I_{OL} = 12\text{ mA}$ | | 0.5 | V |
| V_{OH} | High-level output voltage | $V_{CC} = 4.5\text{ V}$ | $I_{OH} = -2\text{ mA}$ | 2.4 | | V |
| I_{OZL}^* | Offstate output current | $V_{CC} = 5.5\text{ V}$ | $V_O = 0.4\text{ V}$ | | -100 | μA |
| I_{OZH}^* | | | $V_O = 2.4\text{ V}$ | | 100 | |
| I_{OS}^{**} | Output short-circuit current | $V_{CC} = 5.5\text{ V}$ | $V_O = 0.5\text{ V}$ | -30 | -130 | mA |
| I_{CC} | Supply current | $V_{CC} = 5.5\text{ V}$ | | | 210 | mA |

* I/O pin leakage is worst case of IIX or IOZX; i.e., IIL and IOZH.

** Not more than one output should be shorted at a time and duration of the short circuit should not exceed one second.

Military Very High Speed 24-Pin PAL Series

PAL20L8B, 20R8B, 20R6B, 20R4B

Military High Speed 24-Pin PAL Series

PAL20L8A, 20R8A, 20R6A, 20R4A

Switching Characteristics Over operating conditions

| SYMBOL | PARAMETER | TEST CONDITIONS | 24 B | | 24 A | | UNIT |
|-------------|--|--|------|-----|------|-----|------|
| | | | MIN | MAX | MIN | MAX | |
| t_{PD} | Input or feedback to output (except 20R8) | $R_1 = 390 \Omega$ $R_2 = 750 \Omega$ | 20 | | 30 | | ns |
| t_{CLK} | Clock to output or feedback (except 20L8) | | 15 | | 20 | | ns |
| t_{PZX} | Pin 13 to output enable (except 20L8) | | 20 | | 25 | | ns |
| t_{PXZ} | Pin 13 to output disable (except 20L8) | | 20 | | 25 | | ns |
| t_{PZX} | Input to output enable (except 20R8) | | 25 | | 30 | | ns |
| t_{PXZ} | Input to output disable (except 20R8) | | 20 | | 30 | | ns |
| f_{MAX}^* | State machine maximum operating frequency (except 20L8) | 28.5 | | 20 | | MHz | |
| | Data path register maximum operating frequency (except 20L8) | 41.6 | | 25 | | | |

* f_{MAX} is calculated and measured on initial qualifications only.

$$f_{MAX} \text{ (state machine)} = 1/(t_{BU} + t_{CLK})$$

$$f_{MAX} \text{ (data path register)} = 1/(t_{WL} + t_{WH}) \text{ or } 1/t_{BU} + t_H, \text{ whichever is smaller.}$$

Programmed devices conform to Mil-Std-883, Method 5005, Group A, Subgroups 1, 2, 3, 7, 8, 9, 10 and 11.

Military Half-Power 24A-Pin Series

PAL20L8A-2, 20R8A-2, 20R6A-2, 20R4A-2

Can be purchased to standard military drawing 84129, latest revision in effect.

Operating Conditions

| SYMBOL | PARAMETER | MIN | MAX | UNIT |
|------------------|--|------|------|------|
| V_{CC} | Supply voltage | 4.5 | 5.5 | V |
| T_A | Operating free-air temperature | -55 | 125 | °C |
| t_w^\dagger | Width of clock (except 20L8) | Low | 25 | ns |
| | | High | 25 | ns |
| t_{su}^\dagger | Setup time from input or feedback to clock (except 20L8) | 50 | | ns |
| t_h^\dagger | Hold time | 0 | | ns |
| V_{IL}^* | Low-level input voltage | | ≤0.8 | V |
| V_{IH}^* | High-level input voltage | ≥2.0 | | V |

Note: Virgin array verify of unprogrammed PAL device is performed at 25°C only.

* These are absolute voltages with respect to the ground pin on the device and include all overshoots due to system and/or tester noise.

† These are device set-up conditions, which are measured during initial qualification, and are not directly tested.

Electrical Characteristics Over Operating Conditions

| SYMBOL | PARAMETER | TEST CONDITIONS | | MIN | MAX | UNIT |
|---------------|------------------------------|------------------------|--------------------------|-----|-------|------|
| V_{IC} | Input clamp voltage | $V_{CC} = \text{MIN}$ | $I_I = -18 \text{ mA}$ | | -1.5 | V |
| I_{IL}^* | Low-level input current | $V_{CC} = \text{MAX}$ | $V_I = 0.4 \text{ V}$ | | -0.25 | mA |
| I_{IH}^* | High-level input current | $V_{CC} = \text{MAX}$ | $V_I = 2.4 \text{ V}$ | | 25 | μA |
| I_I | Maximum input current | $V_{CC} = \text{MAX}$ | $V_I = 5.5 \text{ V}$ | | 1 | mA |
| V_{OL} | Low-level output voltage | $V_{CC} = \text{MIN}$ | $I_{OL} = 12 \text{ mA}$ | | 0.5 | V |
| V_{OH} | High-level output voltage | $V_{CC} = \text{MIN}$ | $I_{OH} = -2 \text{ mA}$ | 2.4 | | V |
| I_{OZL}^* | Offstate output current | $V_{CC} = \text{MAX}$ | $V_O = 0.4 \text{ V}$ | | -100 | μA |
| I_{OZH}^* | | | $V_O = 2.4 \text{ V}$ | | 100 | μA |
| I_{OS}^{**} | Output short-circuit current | $V_{CC} = 5 \text{ V}$ | $V_O = 0.5 \text{ V}$ | -30 | -130 | mA |
| I_{CC} | Supply Current | $V_{CC} = \text{MAX}$ | | | 105 | mA |

* I/O pin leakage is worst case of IIX or IOZX; i.e., IIL and IOZH.

** Not more than one output should be shorted at a time and duration of the short circuit should not exceed one second.

Military Half-Power 24A-Pin Series

PAL20L8A-2, 20R8A-2, 20R6A-2, 20R4A-2

Switching Characteristics Over Operating Conditions

| SYMBOL | PARAMETER | TEST CONDITIONS | MIN | MAX | UNIT |
|-------------|--|--|------|-----|------|
| t_{PD} | Input or feedback to output (except 20R8) | $R_1 = 390 \Omega$ $R_2 = 750 \Omega$ | | 50 | ns |
| t_{CLK} | Clock to output or feedback (except 20L8) | | | 25 | ns |
| t_{PZX} | Pin 13 to output enable (except 20L8) | | | 25 | ns |
| t_{PXZ} | Pin 13 to output disable (except 20L8) | | | 25 | ns |
| t_{PZX} | Input to output enable (except 20R8) | | | 45 | ns |
| t_{PXZ} | Input to output disable (except 20R8) | | | 45 | ns |
| f_{MAX}^* | State machine maximum operating frequency (except 20L8) | | 13.3 | | MHz |
| | Data path register maximum operating frequency (except 20L8) | | 20 | | |

* f_{MAX} is calculated and measured on initial qualifications only.

$$f_{MAX} \text{ (state machine)} = 1/[t_{su} + t_{CLK}]$$

$$f_{MAX} \text{ (data path register)} = 1/[t_{WL} + t_{WH}] \text{ or } 1/[t_{su} + t_{h}], \text{ whichever is smaller.}$$

Programmed devices conform to Mil-Std-883, Method 5005, Group A, Subgroups 1, 2, 3, 7, 8, 9, 10 and 11.

Military High Speed 24XA-Pin Series

PAL20L10A, 20X10A, 20X8A, 20X4A

Can be purchased to standard military print 84129, latest revision in effect.

Operating Conditions

| SYMBOL | PARAMETER | MIN | MAX | UNIT |
|-----------------|---|------|------|------|
| V_{cc} | Supply voltage | 4.5 | 5.5 | V |
| T_A | Operating free-air temperature | -55 | | °C |
| T_C | Operating case temperature | | 125 | °C |
| t_w^\dagger | Width of clock (except 20L10) | Low | 35 | ns |
| | | High | 20 | |
| t_{w^\dagger} | Setup time from input or feedback to clock (except 20L10) | 40 | | ns |
| t_h^\dagger | Hold time | 0 | | ns |
| V_{IL}^* | Low-level input voltage | | ≤0.8 | V |
| V_{IH}^* | High-level input voltage | ≥2.0 | | V |

Note: Virgin array verify of unprogrammed PAL device is performed at 25°C only.

* These are absolute voltages with respect to the ground pin on the device and include all overshoots due to system and/or tester noise.

† These are device set-up conditions, which are measured during initial qualification, and are not directly tested.

Electrical Characteristics Over Operating Conditions

| SYMBOL | PARAMETER | TEST CONDITIONS | | MIN | MAX | UNIT |
|---------------|------------------------------|------------------------|--------------------------|-----|-------|------|
| V_{IC} | Input clamp voltage | $V_{cc} = \text{MIN}$ | $I_I = -18 \text{ mA}$ | | -1.5 | V |
| I_{IL}^* | Low-level input current | $V_{cc} = \text{MAX}$ | $V_I = 0.4 \text{ V}$ | | -0.25 | mA |
| I_{IH}^* | High-level input current | $V_{cc} = \text{MAX}$ | $V_I = 2.4 \text{ V}$ | | 25 | μA |
| I_I | Maximum input current | $V_{cc} = \text{MAX}$ | $V_I = 5.5 \text{ V}$ | | 1 | mA |
| V_{OL} | Low-level output voltage | $V_{cc} = \text{MIN}$ | $I_{OL} = 12 \text{ mA}$ | | 0.5 | V |
| V_{OH} | High-level output voltage | $V_{cc} = \text{MIN}$ | $I_{OH} = -2 \text{ mA}$ | 2.4 | | V |
| I_{OZL}^* | Off-state output current | $V_{cc} = \text{MAX}$ | $V_o = 0.4 \text{ V}$ | | -100 | μA |
| I_{OZH}^* | | | $V_o = 2.4 \text{ V}$ | | 100 | |
| I_{OS}^{**} | Output short-circuit current | $V_{cc} = 5 \text{ V}$ | $V_o = 0.5 \text{ V}$ | -30 | -130 | mA |
| I_{CC} | Supply current | $V_{cc} = \text{MAX}$ | 20X10A, 20X8A, 20X4A | | 180 | mA |
| | | | 20L10A | | 165 | |

* I/O pin leakage is worst case of IIX or IOZX; i.e., IIL and IOZH.

** Not more than one output should be shorted at a time and duration of the short circuit should not exceed one second.

Military High Speed 24XA-Pin Series

PAL20L10A, 20X10A, 20X8A, 20X4A

Switching Characteristics Over Operating Conditions

| SYMBOL | PARAMETER | TEST CONDITIONS | MIN | MAX | UNIT |
|-------------|--|--|------|------|------|
| t_{PD} | 20L10A, 20X8A, 20X4A Input or feedback to output (except 20X10) | $R_1 = 390 \Omega$ $R_2 = 750 \Omega$ | | 35 | ns |
| t_{CLK} | Clock to output or feedback (except 20L10) | | | 25 | ns |
| t_{PZX} | Pin 13 to output enable (except 20L10) | | | 25 | ns |
| t_{PXZ} | Pin 13 to output disable (except 20L10) | | | 25 | ns |
| t_{PZX} | Input to output enable (except 20X10) | | | 35 | ns |
| t_{PXZ} | Input to output disable (except 20X10) | | | 35 | ns |
| f_{MAX}^* | State machine maximum operating frequency (except 20L10) | | | 15.4 | MHz |
| | Data path register maximum operating frequency (except 20L10) | | 18.2 | | |

* f_{MAX} is calculated and measured on initial qualifications only.

$$f_{MAX} \text{ (state machine)} = 1/[t_{su} + t_{clk}]$$

$$f_{MAX} \text{ (data path register)} = 1/[t_{wl} + t_{wh}] \text{ or } 1/t_{su} + t_r, \text{ whichever is smaller.}$$

Programmed devices conform to Mil-Std-883, Method 5005, Group A, Subgroups 1, 2, 3, 7, 8, 9, 10 and 11.

Military 24RS-Pin Series

PAL20S10, 20RS10, 20RS8, 20RS4

Standard military 5962-87530 is in the process of being generated—Contact the factory.

Operating Conditions

| SYMBOL | PARAMETER | MIN | MAX | UNIT |
|------------------|---|------|------|------|
| V_{CC} | Supply voltage | 4.5 | 5.5 | V |
| T_A | Operating free-air temperature | -55 | | °C |
| T_c | Operating case temperature | | 125 | °C |
| t_w^\dagger | Width of clock (except 20S10) | Low | 20 | ns |
| | | High | 20 | |
| t_{su}^\dagger | Setup time from input or feedback to clock (except 20S10) | 40 | | ns |
| t_h^\dagger | Hold time | 0 | | ns |
| V_{IL}^* | Low-level input voltage | | ≤0.8 | V |
| V_{IH}^* | High-level input voltage | ≥2.0 | | V |

Note: Virgin array verify of unprogrammed PAL device is performed at 25°C only.

* These are absolute voltages with respect to the ground pin on the device and include all overshoots due to system and/or tester noise.

† These are device set-up conditions, which are measured during initial qualification, and are not directly tested.

Electrical Characteristics Over Operating Conditions

| SYMBOL | PARAMETER | TEST CONDITIONS | | MIN | MAX | UNIT |
|---------------|------------------------------|------------------------|--------------------------|-----|-------|------|
| V_{ic} | Input clamp voltage | $V_{CC} = \text{MIN}$ | $I_i = -18 \text{ mA}$ | | -1.5 | V |
| I_{iL}^* | Low-level input current | $V_{CC} = \text{MAX}$ | $V_i = 0.4 \text{ V}$ | | -0.25 | mA |
| I_{iH}^* | High-level input current | $V_{CC} = \text{MAX}$ | $V_i = 2.4 \text{ V}$ | | 25 | μA |
| I_i | Maximum input current | $V_{CC} = \text{MAX}$ | $V_i = 5.5 \text{ V}$ | | 1 | mA |
| V_{oL} | Low-level output voltage | $V_{CC} = \text{MIN}$ | $I_{oL} = 12 \text{ mA}$ | | 0.5 | V |
| V_{oH} | High-level output voltage | $V_{CC} = \text{MIN}$ | $I_{oH} = -2 \text{ mA}$ | 2.4 | | V |
| I_{ozL}^* | Off-state output current | $V_{CC} = \text{MAX}$ | $V_o = 0.4 \text{ V}$ | | -100 | μA |
| I_{ozH}^* | | | $V_o = 2.4 \text{ V}$ | | 100 | |
| I_{os}^{**} | Output short-circuit current | $V_{CC} = 5 \text{ V}$ | $V_o = 0.5 \text{ V}$ | -30 | -130 | mA |
| I_{CC} | Supply current | $V_{CC} = \text{MAX}$ | | | 240 | mA |

* I/O pin leakage is worst case of IIX or IOZX; i.e., IIL and IOZH.

** Not more than one output should be shorted at a time and duration of the short circuit should not exceed one second.

Military 24RS-Pin Series

PAL20S10, 20RS10, 20RS8, 20RS4

Switching Characteristics Over Operating Conditions

| SYMBOL | PARAMETER | TEST CONDITIONS | MIN | MAX | UNIT |
|-------------|--|----------------------|------|-----|------|
| t_{PD} | Input or feedback to output (except 20RS10) | Polarity fuse intact | | 40 | ns |
| | | Polarity fuse Blown | | 45 | |
| t_{CLK} | Clock to output or feedback (except 20S10) | | | 20 | ns |
| t_{PZ1} | Pin 13 to output enable (except 20S10) | $R_1 = 390 \Omega$ | | 25 | ns |
| t_{PZ2} | Pin 13 to output disable (except 20S10) | $R_2 = 750 \Omega$ | | 25 | ns |
| t_{PZ3} | Input to output enable (except 20RS10) | | | 35 | ns |
| t_{PZ4} | Input to output disable (except 20RS10) | | | 30 | ns |
| f_{MAX}^* | State machine maximum operating frequency (except 20S10) | | 16.7 | | MHz |
| | Data path register maximum frequency (except 20S10) | | 25 | | |

* f_{MAX} is calculated and measured on initial qualifications only.

$$f_{MAX} \text{ (state machine)} = 1/[t_{su} + t_{CLK}]$$

$$f_{MAX} \text{ (data path register)} = 1/[t_{WL} + t_{WH}] \text{ or } 1/t_{su} + t_h, \text{ whichever is smaller.}$$

Programmed devices conform to Mil-Std-883, Method 5005, Group A, Subgroups 1, 2, 3, 7, 8, 9, 10 and 11.

Military 24RA-Pin Device

PAL20RA10

Standard military 5962-86803 is in the process of being generated—Contact the factory.

Operating Conditions

| SYMBOL | PARAMETER | | MIN | MAX | UNIT |
|-------------------|--|----------------------|------|-------|------|
| V_{CC} | Supply voltage | | 4.5 | 5 5.5 | V |
| T_A | Operating free-air temperature | | -55 | | °C |
| T_c | Operating case temperature | | | 125 | °C |
| t_w^\dagger | Width of clock | Low | 25 | | ns |
| | | High | 25 | | |
| t_{wp}^\dagger | Preload pulse width | | 45 | | ns |
| t_{su}^\dagger | Setup time from input or feedback to clock | | 25 | | ns |
| t_{sup}^\dagger | Preload setup time | | 30 | | ns |
| t_h^\dagger | Hold time | Polarity fuse intact | 10 | | ns |
| | | Polarity fuse blown | 0 | | |
| t_{hp}^\dagger | Preload hold time | | 30 | | ns |
| V_L^* | Low-level input voltage | | | ≤0.8 | V |
| V_{IH}^* | High-level input voltage | | ≥2.0 | | V |

Note: Virgin array verify of unprogrammed PAL device is performed at 25°C only.

* These are absolute voltages with respect to the ground pin on the device and include all overshoots due to system and/or tester noise.

† These are device set-up conditions, which are measured during initial qualification, and are not directly tested.

Electrical Characteristics Over Operating Conditions

| SYMBOL | PARAMETER | TEST CONDITIONS | | MIN | TYP | MAX | UNIT |
|---------------|------------------------------|------------------------|--------------------------|-----|-----|-------|------|
| V_{IC} | Input clamp voltage | $V_{CC} = \text{MIN}$ | $I_i = -18 \text{ mA}$ | | | -1.5 | V |
| I_{IL}^* | Low-level input current | $V_{CC} = \text{MAX}$ | $V_i = 0.4 \text{ V}$ | | | -0.25 | mA |
| I_{IH}^* | High-level input current | $V_{CC} = \text{MAX}$ | $V_i = 2.4 \text{ V}$ | | | 25 | μA |
| I_i | Maximum input current | $V_{CC} = \text{MAX}$ | $V_i = 5.5 \text{ V}$ | | | 1 | mA |
| V_{OL} | Low-level output voltage | $V_{CC} = \text{MIN}$ | $I_{OL} = 8 \text{ mA}$ | | | 0.5 | V |
| V_{OH} | High-level output voltage | $V_{CC} = \text{MIN}$ | $I_{OH} = -2 \text{ mA}$ | 2.4 | | | V |
| I_{ozL}^* | Off-state output current | $V_{CC} = \text{MAX}$ | $V_o = 0.4 \text{ V}$ | | | -100 | μA |
| I_{ozH}^* | | | $V_o = 2.4 \text{ V}$ | | | 100 | |
| I_{OS}^{**} | Output short-circuit current | $V_{CC} = 5 \text{ V}$ | $V_o = 0.5 \text{ V}$ | -30 | | -130 | mA |
| I_{CC} | Supply current | $V_{CC} = \text{MAX}$ | | | | 200 | mA |

* I/O pin leakage is worst case of IIX or IOZX; i.e., IIL and IOZH.

** Not more than one output should be shorted at a time and duration of the short circuit should not exceed one second.

Military 24-Pin PAL Devices

Military 24RA-Pin Device

PAL20RA10

Switching Characteristics Over Operating Conditions

| SYMBOL | PARAMETER | | TEST CONDITIONS | MIN | MAX | UNIT |
|-------------|---|----------------------|---|-----|------|------|
| | | | | | | |
| t_{PD} | Input or feedback to output | Polarity fuse intact | $R_1 = 560 \Omega$ $R_2 = 1.1 K\Omega$ | | 35 | ns |
| | | Polarity fuse Blown | | | 40 | |
| t_{CLK} | Clock to output or feedback | | | | 35 | ns |
| t_S | Input to asynchronous set | | | | 40 | ns |
| t_R | Input to asynchronous reset | | | | 45 | ns |
| t_{PZX} | Pin 13 to output enable | | | | 25 | ns |
| t_{PXZ} | Pin 13 to output disable | | | | 25 | ns |
| t_{PZX} | Input to output enable | | | | 35 | ns |
| t_{PXZ} | Input to output disable | | | | 35 | ns |
| f_{MAX}^* | State machine maximum operating frequency | | | | 16.7 | MHz |
| | Data path register maximum frequency | | | 20 | | |

* f_{MAX} is calculated and measured on initial qualifications only.

$$f_{MAX} \text{ (state machine)} = 1/[t_{su} + t_{clk}]$$

$$f_{MAX} \text{ (data path register)} = 1/[t_{wl} + t_{wh}] \text{ or } 1/[t_{su} + t_r], \text{ whichever is smaller.}$$

Programmed devices conform to Mil-Std-883, Method 5005, Group A, Subgroups 1, 2, 3, 7, 8, 9, 10 and 11.

ADVANCE INFORMATION

Operating Conditions

| SYMBOL | PARAMETER | STD | | A | | UNIT |
|------------------|--|----------------------------------|------|------|------|------|
| | | MIN | MAX | MIN | MAX | |
| V_{CC} | Supply voltage | 4.5 | 5.5 | 4.5 | 5.5 | V |
| T_A | Operating free-air temperature | -55 | 125 | -55 | 125 | °C |
| t_w^\dagger | Width of clock | Low | 25 | 23 | | ns |
| | | High | 25 | 23 | | |
| t_{su}^\dagger | Setup time from input or feedback to clock | Product terms P_1 - P_n , SR | 35 | 30 | | ns |
| | | Product term XOR | 40 | 35 | | |
| t_h^\dagger | Hold time | 0 | | 0 | | ns |
| t_{pw}^\dagger | Asynchronous preset width | 35 | | 30 | | ns |
| t_{sr}^\dagger | Asynchronous preset recovery time | 35 | | 30 | | ns |
| t_{sr}^\dagger | Synchronous reset recovery time | 35 | | 30 | | ns |
| V_{IL}^* | Low-level input voltage | | ≤0.8 | | ≤0.8 | V |
| V_{IH}^* | High-level input voltage | ≥2.0 | | ≥2.0 | | V |

Note: Virgin array verify of unprogrammed PAL device is performed at 25°C only.

* These voltages apply with respect to the ground pin on the device and include all overshoots due to system and/or tester noise.

† These are device set-up conditions, which are measured during initial qualification, and are not directly tested.

Electrical Characteristics Over Operating Conditions

| SYMBOL | PARAMETER | TEST CONDITIONS | | MIN | MAX | UNIT |
|---------------|------------------------------|------------------------|--------------------------|-----|-------|------|
| V_{IC} | Input clamp voltage | $V_{CC} = \text{MIN}$ | $I_I = -18 \text{ mA}$ | | -1.5 | V |
| I_{IL}^* | Low-level input current | $V_{CC} = \text{MAX}$ | $V_I = 0.4 \text{ V}$ | | -0.25 | mA |
| I_{IH}^* | High-level input current | $V_{CC} = \text{MAX}$ | $V_I = 2.4 \text{ V}$ | | 25 | μA |
| I_I | Maximum input current | $V_{CC} = \text{MAX}$ | $V_I = 5.5 \text{ V}$ | | 200 | μA |
| V_{OL} | Low-level output voltage | $V_{CC} = \text{MIN}$ | $I_{OL} = 12 \text{ mA}$ | | 0.5 | V |
| V_{OH} | High-level output voltage | $V_{CC} = \text{MIN}$ | $I_{OH} = -2 \text{ mA}$ | 2.4 | | V |
| I_{OZL}^* | Off-state output current | $V_{CC} = \text{MAX}$ | $V_O = 0.4 \text{ V}$ | | -100 | μA |
| I_{OZH}^* | | | $V_O = 2.4 \text{ V}$ | | 100 | μA |
| I_{OS}^{**} | Output short-circuit current | $V_{CC} = 5 \text{ V}$ | $V_O = 0.5 \text{ V}$ | -30 | -130 | mA |
| I_{CC} | Supply current | $V_{CC} = \text{MAX}$ | | | 180 | mA |

* I/O pin leakage is worst case of IIX or IOZX; i.e., IIL and IOZH.

** Not more than one output should be shorted at a time and duration of the short circuit should not exceed one second.

ADVANCE INFORMATION

Switching Characteristics Over Operating Conditions

| SYMBOL | PARAMETER | | TEST CONDITIONS | STD | | A | | UNIT |
|-------------|---|-------------------------|--|-------------------------|------|------|-----|------|
| | | | | MIN | MAX | MIN | MAX | |
| t_{PD} | Input or feedback to output | Product terms P_1-P_n | $R_1 = 390 \Omega$ $R_2 = 750 \Omega$ | | 35 | | 30 | ns |
| | | Product term XOR | | | 40 | | 35 | |
| t_{CLK} | Clock to output or feedback | | | 20 | | 20 | ns | |
| t_{PZX} | Input to output enable | | | 35 | | 30 | ns | |
| t_{PXZ} | Input to output disable | | | 35 | | 30 | ns | |
| t_{AP} | Asynchronous preset to output | | | 35 | | 30 | ns | |
| t_{CR} | Input or feedback to registered output from combinatorial configuration | | | 95 | | 95 | ns | |
| t_{RC} | Input or feedback to combinatorial output from registered configuration | | | 95 | | 95 | ns | |
| f_{MAX}^* | Maximum frequency | Feedback ($1/t_{PI}$) | | Product terms P_1-P_n | 18 | | 20 | MHz |
| | | | | Product term XOR | 16.7 | | 18 | |
| | | No feedback** | | 20 | | 21.7 | | |

* f_{MAX} is calculated and measured on initial qualifications only.

$$f_{MAX} \text{ (NO feedback)} = 1/[t_{WL} + t_{WH}]$$

Programmed devices conform to Mil-Std-883, Method 5005, Group A, Subgroups 1, 2, 3, 7, 8, 9, 10 and 11.

Military 24-Pin PAL Devices

Switching Waveforms

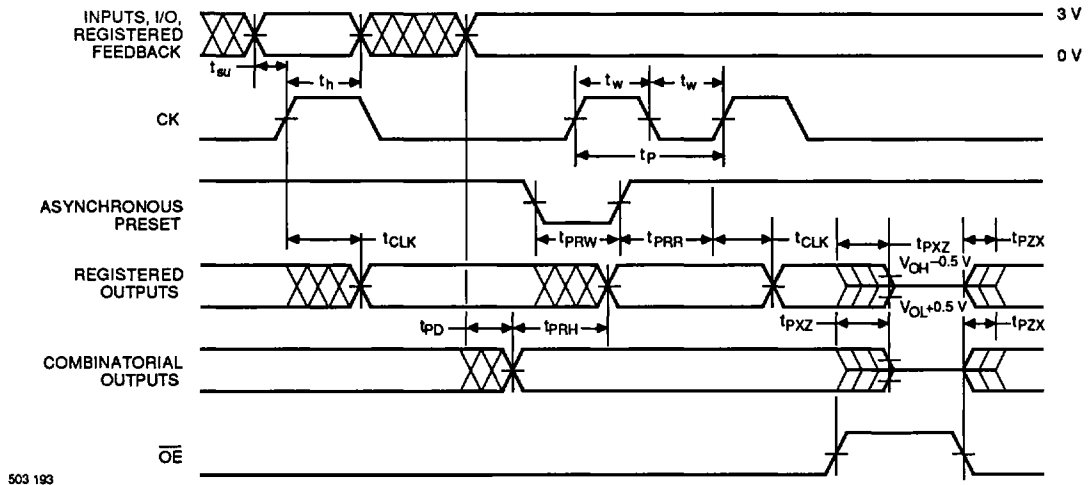

503 193

- Notes:
1. t_{PD} is tested with switch S_1 closed, $C_L = 50$ pF and measured at 1.5 V output level.
 2. t_{PZH} is measured at the 1.5 V output level with $C_L = 50$ pF. S_1 is open for high impedance "1" test and closed for high impedance "0" test.
 3. t_{PZL} is tested with $C_L = 5$ pF. S_1 is open for "1" to high impedance test measured at $V_{OH} - 0.5$ V output level. S_1 is closed for "0" to high impedance test measured at $V_{OL} + 0.5$ V output level.
 4. Equivalent test loads may be used on automatic test equipment.

Switching Test Load

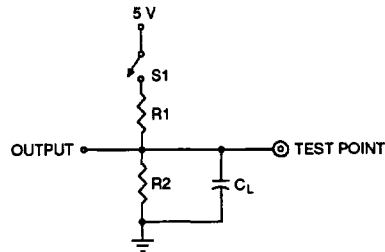

503 194

Output Register Preload PAL24XA Series, PAL24RS Series and PAL20RA10 Device

1. Raise V_{oc} to 4.5 V.
2. Disable output registers by setting pin 13 to V_H .
3. Apply V_{IL}/V_{IH} to all registered output pins.
4. Pulse pin 10 to V_p then back to 0 V.
5. Remove V_{IL}/V_{IH} from all output registers.
6. Lower pin 13 to V_{IL} to enable the output registers.
7. Verify for V_{OL}/V_{OH} at all registered output pins.

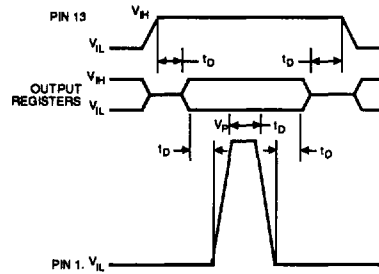

503 195

Output Register Preload PAL32VX10 Device

The preload function allows the register to be loaded from the output pins. This feature aids the functional testing of sequential designs by allowing direct setting of output states. The procedure is:

1. Raise V_{oc} to 4.5 V.
2. Disable output registers by setting pin 2 to V_{IH} (12 V).
3. Apply V_{IL}/V_{IH} to all registered output pins. Leave combinatorial outputs floating.
4. Pulse pin 10 to V_{IH} , then back to 0 V.
5. Remove V_{IL}/V_{IH} from all output registers.
6. Remove high voltage from pin 2.
7. Enable registered outputs per programmed pattern.
8. Verify for V_{OL}/V_{OH} at all registered output pins.

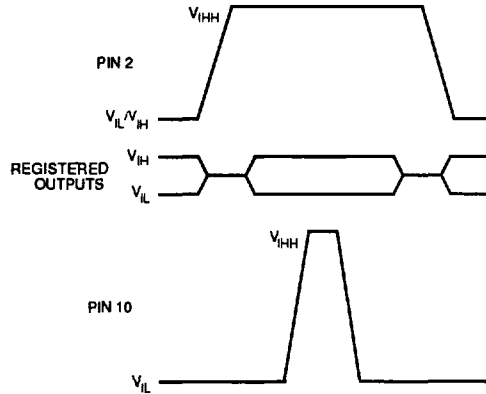

503 196

5

Key to Timing Diagrams

| WAVEFORM | INPUTS | OUTPUTS |
|----------|---------------------------------|--|
| | DON'T CARE: CHANGE PERMITTED | CHANGING: STATE UNKNOWN |
| | NOT APPLICABLE | CENTER LINE IS HIGH IMPEDANCE STATE |
| | MUST BE STEADY | WILL BE STEADY |

503 197

Military 24-Pin PAL Devices

Life Test/Burn-In Circuits

Complies with Mil-Std-883, Method 1005/1015, Condition D.

Circuit Configurations

Waveforms

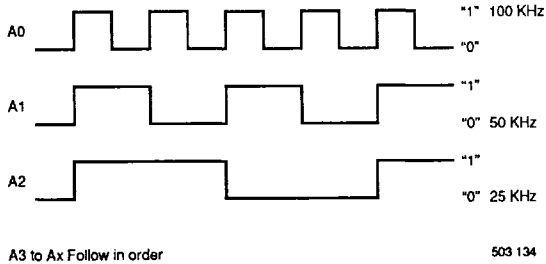

1. All Burn-In will be accomplished at 125°C +5/-0°C
2. $V_{CC} = 5.25 \text{ volts} \pm 0.25 \text{ V}$
3. All Clocks (A0 to Ax) are square wave signals 50±15% Duty Cycle, with:
 - a. "0" = -0.5 V to +0.7 V
 - b. "1" = +2.4 V to V_{CC}
 - c. Rise Time (+0.7 V to +2.4 V) < 1 μsec
 - d. Fall Time (+2.4 V to +0.7 V) < 1 μsec
4. Resistor Value
330 Ω or 470 Ω ±5%
5. All Board Components to be compatible with 150°C Ambient (Min).

PAL12L10

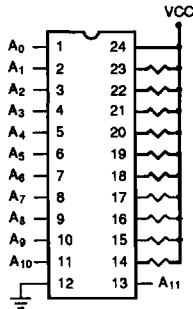

PAL14L8

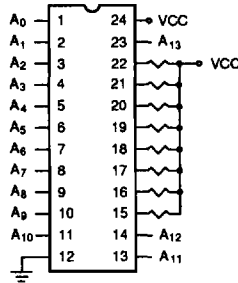

PAL16L6

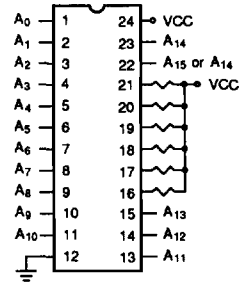

503 199

Military 24-Pin PAL Devices

Life Test/Burn-In Circuits

Complies with Mil-Std-883, Method 1005/1015, Condition D.

Circuit Configurations

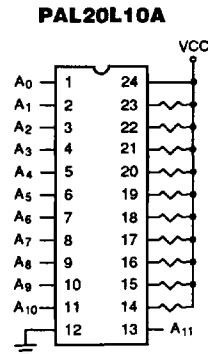
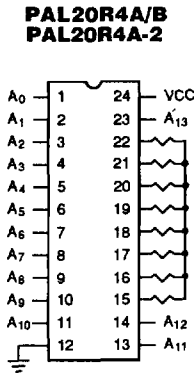
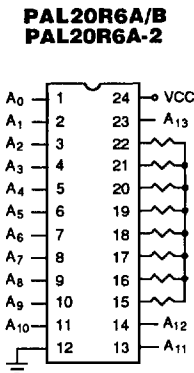
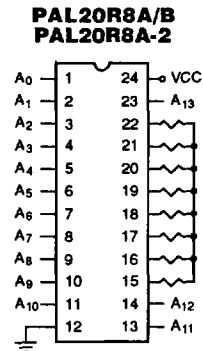
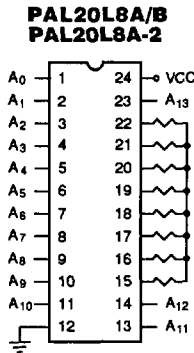
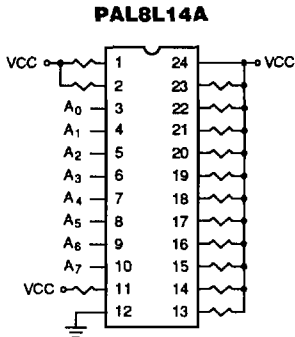
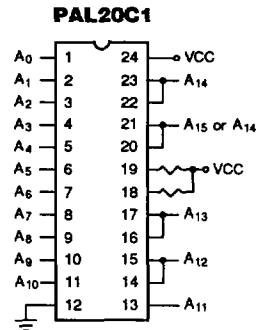
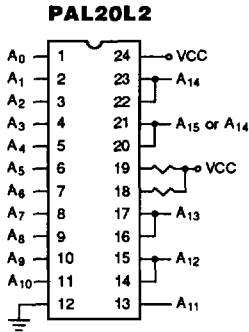
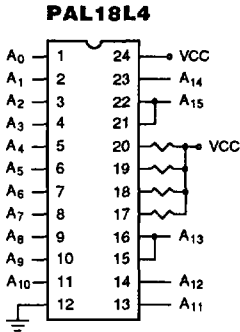

5

503 202

Military 24-Pin PAL Devices

Life Test/Burn-In Circuits

Complies with Mil-Std-883, Method 1005/1015, Condition D.

Circuit Configurations

