

**1 310 nm InGaAsP MQW-DFB LASER DIODE
COAXIAL MODULE FOR 622 Mb/s**

DESCRIPTION

The NX8303BG-CC and NX8303CG-CC are 1 310 nm Multiple Quantum Well (MQW) structured Distributed Feed-Back (DFB) laser diode coaxial module with single mode fiber.

These modules are ideal as a light source for Synchronous Digital Hierarchy (SDH) system, STM-4, long-haul L-4.1 ITU-T recommendations.

FEATURES

- Peak emission wavelength $\lambda_p = 1\,310\text{ nm}$
- Optical output power $P_f = 2.0\text{ mW}$
- Wide operating temperature range $T_c = -10\text{ to }+85^\circ\text{C}$
- Side Mode Suppression Ratio $\text{SMSR} = 40\text{ dB}$
- InGaAs monitor PIN-PD
- With SC-UPC connector
- Based on Telcordia reliability

The information in this document is subject to change without notice. Before using this document, please confirm that this is the latest version.
Not all devices/types available in every country. Please check with local NEC Compound Semiconductor Devices representative for availability and additional information.

PACKAGE DIMENSIONS (UNIT : mm)

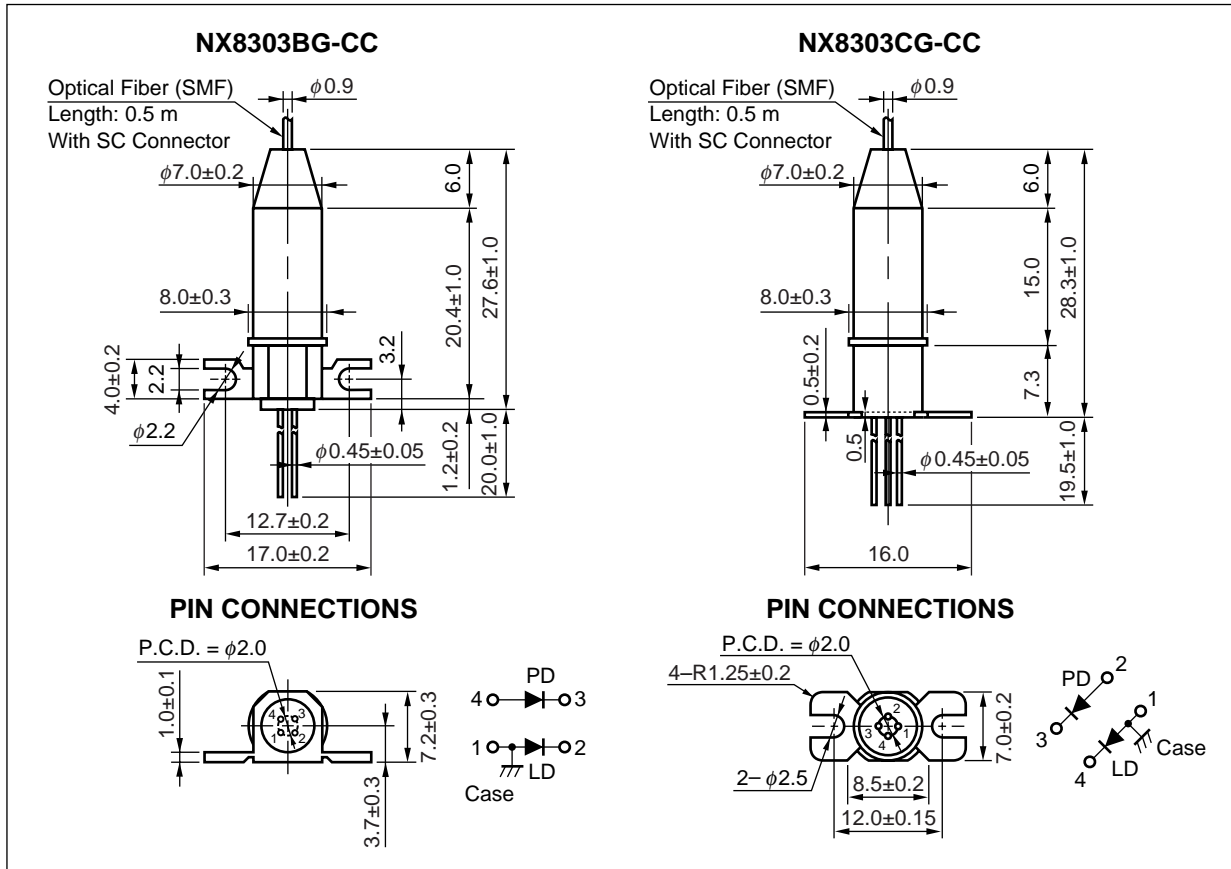

OPTICAL FIBER CHARACTERISTICS

Parameter	Specification	Unit
Mode Field Diameter	9.5 \pm 1	μm
Cladding Diameter	125 \pm 2	μm
Maximum Cladding Noncircularity	2	%
Maximum Core/Cladding Concentricity	1.6	%
Outer Diameter	0.9 \pm 0.1	mm
Cut-off Wavelength	1 100 to 1 270	nm
Minimum Fiber Bending Radius	30	mm
Fiber Length	500 \pm 50	mm
Flammability	UL1581 VW-1	

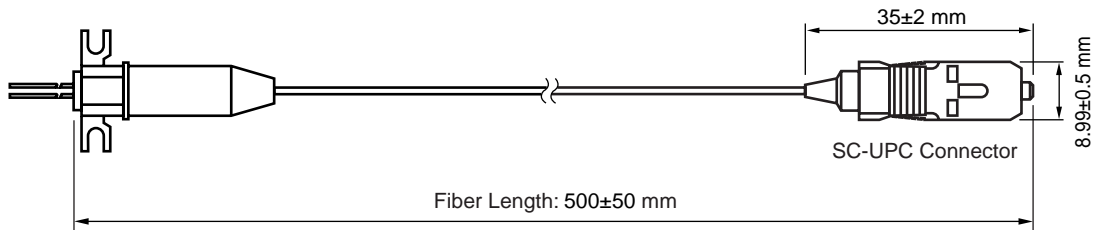

ORDERING INFORMATION

Part Number	Flange Type	Available Connector
NX8303BG-CC	Flat Mount Flange	With SC-UPC Connector
NX8303CG-CC	Vertical Mount Flange	

ABSOLUTE MAXIMUM RATINGS

Parameter	Symbol	Ratings	Unit
Optical Output Power from Fiber	P_r	5	mW
Forward Current of LD	I_F	150	mA
Reverse Voltage of LD	V_R	2.0	V
Forward Current of PD	I_F	2.0	mA
Reverse Voltage of PD	V_R	15	V
Operating Case Temperature	T_c	-10 to +85	°C
Storage Temperature	T_{stg}	-40 to +85	°C
Lead Soldering Temperature	T_{sld}	260 (10 sec.)	°C
Relative Humidity (noncondensing)	RH	85	%

ELECTRO-OPTICAL CHARACTERISTICS (T_c = -10 to +85°C, unless otherwise specified)

Parameter	Symbol	Conditions	MIN.	TYP.	MAX.	Unit
Optical Output Power from Fiber	P _f	CW		2.0		mW
Operating Voltage	V _{op}	P _f = 2.0 mW		1.2	1.6	V
Threshold Current	I _{th}	T _c = 25°C		15	25	mA
					55	
Threshold Output Power	P _{th}	I _F = I _{th}			100	μW
Modulation Current	I _{mod}	P _f = 2.0 mW, T _c = 25°C	8	20	30	mA
		P _f = 2.0 mW	6		50	
Differential Efficiency	η _d	P _f = 2.0 mW, T _c = 25°C	0.070	0.100	0.200	W/A
		P _f = 2.0 mW	0.040		0.300	
Temperature Dependence of Differential Efficiency	Δη _d	$\Delta\eta_d = 10 \log \frac{\eta_d (@ T_c \text{ } ^\circ\text{C})}{\eta_d (@ 25^\circ\text{C})}$	-3.5	-2.2		dB
Kink (Refer to DEFINITIONS)	kink	P _f = Up to 2.4 mW			±20	%
Peak Emission Wavelength	λ _p	P _f = 2.0 mW	1 280	1 310	1 335	nm
Temperature Dependence of Peak Emission Wavelength	Δλ/ΔT			0.09	0.1	nm/°C
Spectral Width	Δλ	P _f = 2.0 mW, -20 dB down width		0.1	1.0	nm
Side Mode Suppression Ratio	SMSR	P _f = 2.0 mW	30	40		dB
Cutt-off Frequency	f _c	-3 dB, V _R = 5 V, P _f = 2.0 mW		2.0		GHz
Rise Time	t _r	10-90%, P _{pk} = 2.0 mW, I _F = I _{th}		0.15	0.5	ns
Fall Time	t _f	90-10%, P _{pk} = 2.0 mW, I _F = I _{th}		0.15	0.5	ns
Monitor Current	I _m	V _R = 5 V, P _f = 2.0 mW	200	700	1 500	μA
Monitor Dark Current	I _D	V _R = 5 V, T _c = 25°C		0.1	50	nA
		V _R = 5 V		10	500	
Monitor PD Terminal Capacitance	C _t	V _R = 5 V, f = 1 MHz		1.0	20	pF
Linearity (Refer to DEFINITIONS)	LIN _m	V _R = 5 V, P _f = 0.2 to 2.0 mW			10	%
Tracking Error (Refer to DEFINITIONS)	γ	I _m = const.		0.5	1.0	dB
Relative Intensity Noise	RIN	Ref = -14 dB		-135		dB/Hz

★ PARAMETER DEFINITIONS

Kink : kink

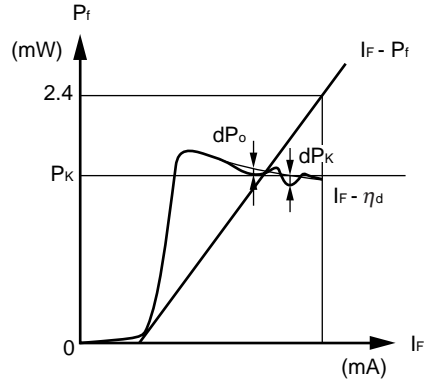

$$\text{kink} = \frac{|dP_K|}{P_K} \times 100 \text{ [\%]}$$

$dP_K = dP_o \text{ MAX.}$
 $P_K \leq 2.4 \text{ (mW)}$

Linearity : LIN_m

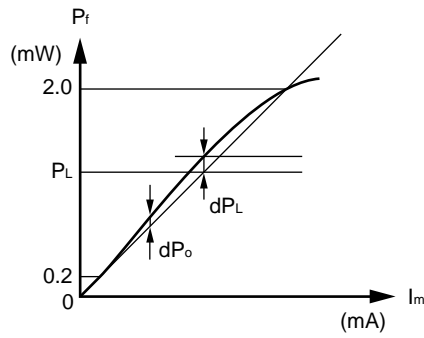

$$\text{LIN}_m = \frac{|dP_L|}{P_L} \times 100 \text{ [\%]}$$

$dP_L = dP_o \text{ MAX.}$
 $0.2 < P_L < 2.0 \text{ (mW)}$

Tracking Error : γ

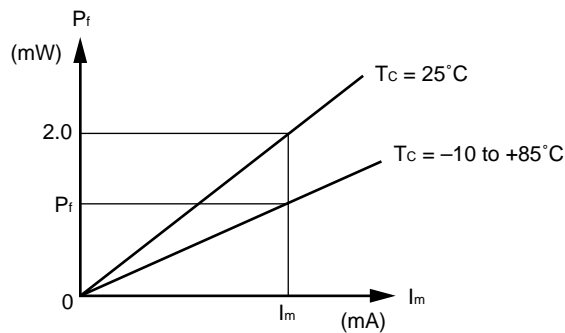

$$\gamma = \left| 10 \log \frac{P_f}{2.0} \right| \text{ [dB]}$$

TYPICAL CHARACTERISTICS ($T_c = 25^\circ\text{C}$, unless otherwise specified)

OPERATING CURRENT AND THRESHOLD CURRENT vs. CASE TEMPERATURE

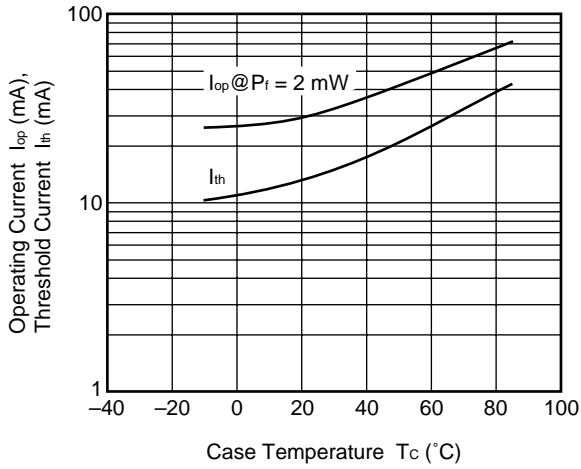

TEMPERATURE DEPENDENCE OF PEAK EMISSION WAVELENGTH

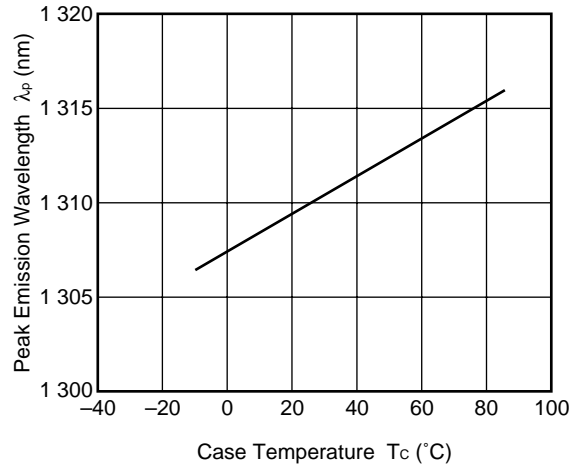

TEMPERATURE DEPENDENCE OF DIFFERENTIAL EFFICIENCY

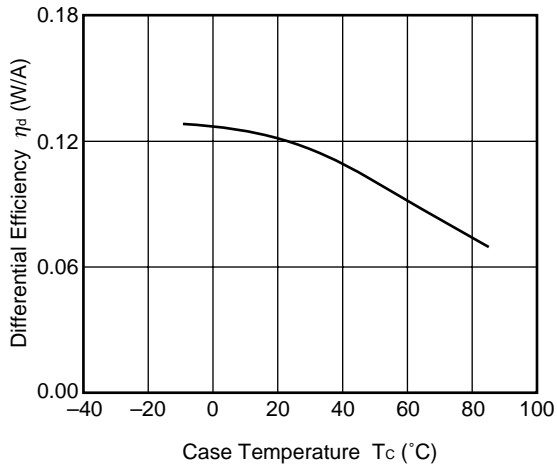

FORWARD CURRENT vs. FORWARD VOLTAGE

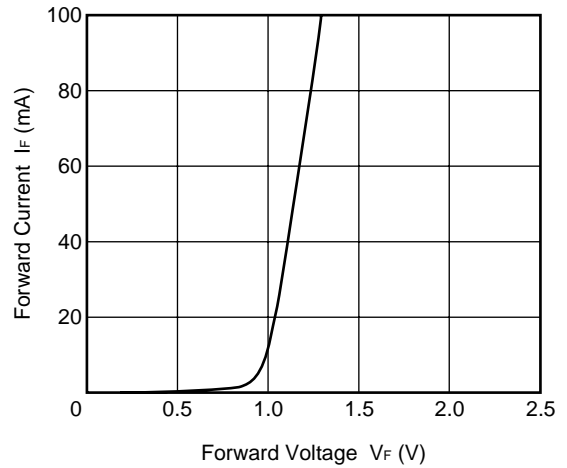

SPECTRUM

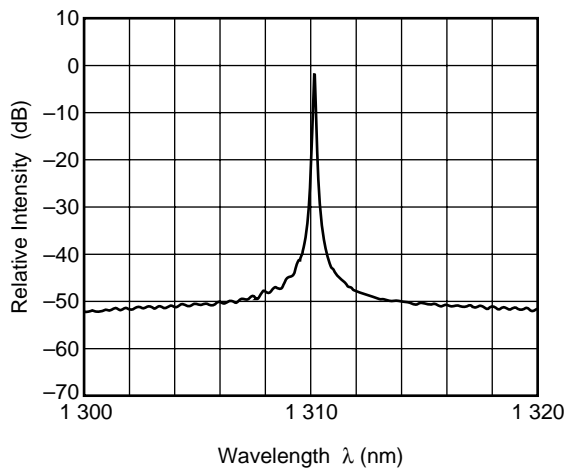

Remark The graphs indicate nominal characteristics.

DFB-LD FAMILY

Part Number	Absolute Maximum Ratings		Electro-Optical Characteristics (T _C = 25°C)			Application	Package
	T _C (°C)	T _{stg} (°C)	I _{th} (mA)	P _r (mW)	λ _p (nm)		
			TYP.	MIN.	TYP.		
NX8300BE-CC NX8300CE-CC	0 to +75	-40 to +85	15	2 ^{*1}	1 310	2.5 Gb/s: STM-16 (S-16.1, L-16.1)	Coaxial
NX8303BG-CC NX8303CG-CC	-10 to +85	-40 to +85	15	2 ^{*1}	1 310	622 Mb/s: STM-4 (L-4.1)	Coaxial
★ NX8304BE-CC NX8304CE-CC	-40 to +85	-40 to +85	15	2 ^{*1}	1 310	For fiberoptic communications	Coaxial
NX8503BG-CC NX8503CG-CC	-10 to +85	-40 to +85	15	2 ^{*1}	1 550	156 Mb/s: STM-1 (L-1.2, L-1.3)	Coaxial
						622 Mb/s: STM-4 (L-4.2, L-4.3)	
NX8504BE-CC NX8504CE-CC	-10 to +85	-40 to +85	15	2 ^{*1}	1 550	622 Mb/s: STM-4 (L-4.2, L-4.3)	Coaxial
★ NX8560LJ-CC	-20 to +70	-40 to +85	6	-1 dBm	1 550 ^{*2}	≤ 10 Gb/s: STM-64	BFY with GPO™
NX8562LB	-20 to +65	-40 to +85	20	20	1 550 ^{*2}	CW Light Source for external modulator	BFY
NX8563LB	-20 to +65	-40 to +85	20	10	1 550 ^{*2}	CW Light Source for external modulator	BFY
★ NX8564LE-CC	-20 to +70	-40 to +85	7	-2 dBm ^{*1}	1 550 ^{*2}	2.5 Gb/s: STM-16, 360 km EA modulator integrated	BFY
★ NX8565LE-CC	-20 to +70	-40 to +85	7	-2 dBm ^{*1}	1 550 ^{*2}	2.5 Gb/s: STM-16, 600 km EA modulator integrated	BFY
★ NX8566LE-CC	-20 to +70	-40 to +85	7	0 dBm	1 550 ^{*2}	2.5 Gb/s: STM-16, 240 km EA modulator integrated	BFY
NX8570 Series	-20 to +70	-40 to +85	20	20	1 550 ^{*2}	CW Light Source with λ monitoring PD	BFY
NX8571 Series	-20 to +70	-40 to +85	20	10	1 550 ^{*2}	CW Light Source with λ monitoring PD	BFY

*1 TYP.

*2 Available for DWDM Wavelengths based on ITU-T recommendations

REFERENCE

Document Name	Document No.
Optical semiconductor devices for fiberoptic communications Selection Guide	P12480E
Opto-Electronics Devices Pamphlet	P13623E
Opto-Electronics Devices (CD-ROM)	P12944X
NEC semiconductor device reliability/quality control system ^{*1}	C11159E
Quality grades on NEC semiconductor devices ^{*1}	C11531E
SEMICONDUCTOR SELECTION GUIDE –Products and Packages– ^{*1}	X13769E

*1 Published by NEC Corporation

GPO is a trademark of Gilbert Engineering Co., Inc.

- **The information in this document is current as of July, 2002. The information is subject to change without notice. For actual design-in, refer to the latest publications of NEC's data sheets or data books, etc., for the most up-to-date specifications of NEC semiconductor products. Not all products and/or types are available in every country. Please check with an NEC sales representative for availability and additional information.**
 - No part of this document may be copied or reproduced in any form or by any means without prior written consent of NEC. NEC assumes no responsibility for any errors that may appear in this document.
 - NEC does not assume any liability for infringement of patents, copyrights or other intellectual property rights of third parties by or arising from the use of NEC semiconductor products listed in this document or any other liability arising from the use of such products. No license, express, implied or otherwise, is granted under any patents, copyrights or other intellectual property rights of NEC or others.
 - Descriptions of circuits, software and other related information in this document are provided for illustrative purposes in semiconductor product operation and application examples. The incorporation of these circuits, software and information in the design of customer's equipment shall be done under the full responsibility of customer. NEC assumes no responsibility for any losses incurred by customers or third parties arising from the use of these circuits, software and information.
 - While NEC endeavours to enhance the quality, reliability and safety of NEC semiconductor products, customers agree and acknowledge that the possibility of defects thereof cannot be eliminated entirely. To minimize risks of damage to property or injury (including death) to persons arising from defects in NEC semiconductor products, customers must incorporate sufficient safety measures in their design, such as redundancy, fire-containment, and anti-failure features.
 - NEC semiconductor products are classified into the following three quality grades:
 "Standard", "Special" and "Specific". The "Specific" quality grade applies only to semiconductor products developed based on a customer-designated "quality assurance program" for a specific application. The recommended applications of a semiconductor product depend on its quality grade, as indicated below. Customers must check the quality grade of each semiconductor product before using it in a particular application.
 "Standard": Computers, office equipment, communications equipment, test and measurement equipment, audio and visual equipment, home electronic appliances, machine tools, personal electronic equipment and industrial robots
 "Special": Transportation equipment (automobiles, trains, ships, etc.), traffic control systems, anti-disaster systems, anti-crime systems, safety equipment and medical equipment (not specifically designed for life support)
 "Specific": Aircraft, aerospace equipment, submersible repeaters, nuclear reactor control systems, life support systems and medical equipment for life support, etc.
- The quality grade of NEC semiconductor products is "Standard" unless otherwise expressly specified in NEC's data sheets or data books, etc. If customers wish to use NEC semiconductor products in applications not intended by NEC, they must contact an NEC sales representative in advance to determine NEC's willingness to support a given application.
- (Note)
- (1) "NEC" as used in this statement means NEC Corporation, NEC Compound Semiconductor Devices, Ltd. and also includes its majority-owned subsidiaries.
 - (2) "NEC semiconductor products" means any semiconductor product developed or manufactured by or for NEC (as defined above).

M8E 00.4-0110

SAFETY INFORMATION ON THIS PRODUCT

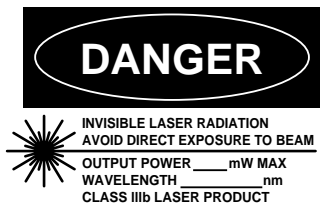

SEMICONDUCTOR LASER



AVOID EXPOSURE-Invisible
 Laser Radiation is emitted from
 this aperture

<p>Warning Laser Beam</p>	<p>A laser beam is emitted from this diode during operation. The laser beam, visible or invisible, directly or indirectly, may cause injury to the eye or loss of eyesight.</p> <ul style="list-style-type: none"> • Do not look directly into the laser beam. • Avoid exposure to the laser beam, any reflected or collimated beam.
<p>Caution GaAs Products</p>	<p>The product contains gallium arsenide, GaAs. GaAs vapor and powder are hazardous to human health if inhaled or ingested.</p> <ul style="list-style-type: none"> • Do not destroy or burn the product. • Do not cut or cleave off any part of the product. • Do not crush or chemically dissolve the product. • Do not put the product in the mouth. <p>Follow related laws and ordinances for disposal. The product should be excluded from general industrial waste or household garbage.</p>
<p>Caution Optical Fiber</p>	<p>A glass-fiber is attached on the product. Handle with care.</p> <ul style="list-style-type: none"> • When the fiber is broken or damaged, handle carefully to avoid injury from the damaged part or fragments.

► **Business issue**

NEC Compound Semiconductor Devices, Ltd.

5th Sales Group, Sales Division TEL: +81-3-3798-6372 FAX: +81-3-3798-6783 E-mail: salesinfo@csd-nec.com

NEC Compound Semiconductor Devices Hong Kong Limited

Hong Kong Head Office TEL: +852-3107-7303 FAX: +852-3107-7309
 Taipei Branch Office TEL: +886-2-8712-0478 FAX: +886-2-2545-3859
 Korea Branch Office TEL: +82-2-528-0301 FAX: +82-2-528-0302

NEC Electron Devices European Operations <http://www.nec.de/>

TEL: +49-211-6503-101 FAX: +49-211-6503-487

California Eastern Laboratories, Inc. <http://www.cel.com/>

TEL: +1-408-988-3500 FAX: +1-408-988-0279

► **Technical issue**

NEC Compound Semiconductor Devices, Ltd. <http://www.csd-nec.com/>

Sales Engineering Group, Sales Division
 E-mail: techinfo@csd-nec.com FAX: +81-44-435-1918