

LME49710

High Performance, High Fidelity Audio Operational Amplifier

General Description

The LME49710 is part of the ultra-low distortion, low noise, high slew rate operational amplifier series optimized and fully specified for high performance, high fidelity applications. Combining advanced leading-edge process technology with state-of-the-art circuit design, the LME49710 audio operational amplifiers deliver superior audio signal amplification for outstanding audio performance. The LME49710 combines extremely low voltage noise density ($2.5\text{nV}/\sqrt{\text{Hz}}$) with vanishingly low THD+N (0.00003%) to easily satisfy the most demanding audio applications. To ensure that the most challenging loads are driven without compromise, the LME49710 has a high slew rate of $\pm 20\text{V}/\mu\text{s}$ and an output current capability of $\pm 26\text{mA}$. Further, dynamic range is maximized by an output stage that drives $2\text{k}\Omega$ loads to within 1V of either power supply voltage and to within 1.4V when driving 600Ω loads.

The LME49710's outstanding CMRR (120dB), PSRR (120dB), and V_{OS} (0.05mV) give the amplifier excellent operational amplifier DC performance.

The LME49710 has a wide supply range of $\pm 2.5\text{V}$ to $\pm 17\text{V}$. Over this supply range the LME49710's input circuitry maintains excellent common-mode and power supply rejection, as well as maintaining its low input bias current. The LME49710 is unity gain stable. The Audio Operational Amplifier achieves outstanding AC performance while driving complex loads with values as high as 100pF .

The LME49710 is available in 8-lead narrow body SOIC, 8-lead plastic DIP, and 8-lead metal can TO-99. Demonstration boards are available for each package.

Key Specifications

| | |
|---|---------------------------------------|
| ■ Power Supply Voltage Range | $\pm 2.5\text{V}$ to $\pm 17\text{V}$ |
| ■ THD+N ($A_V = 1$, $V_{OUT} = 3V_{RMS}$, $f_{IN} = 1\text{kHz}$) | |
| $R_L = 2\text{k}\Omega$ | 0.00003% (typ) |
| $R_L = 600\Omega$ | 0.00003% (typ) |
| ■ Input Noise Density | $2.5\text{nV}/\sqrt{\text{Hz}}$ (typ) |
| ■ Slew Rate | $\pm 20\text{V}/\mu\text{s}$ (typ) |
| ■ Gain Bandwidth Product | 55MHz (typ) |
| ■ Open Loop Gain ($R_L = 600\Omega$) | 140dB (typ) |
| ■ Input Bias Current | 7nA (typ) |
| ■ Input Offset Voltage | 0.05mV (typ) |
| ■ DC Gain Linearity Error | 0.000009% |

Features

- Easily drives 600Ω loads
- Optimized for superior audio signal fidelity
- Output short circuit protection
- PSRR and CMRR exceed 120dB (typ)
- SOIC, DIP, TO-99 metal can packages

Applications

- Ultra high quality audio amplification
- High fidelity preamplifiers
- High fidelity multimedia
- State of the art phono pre amps
- High performance professional audio
- High fidelity equalization and crossover networks
- High performance line drivers
- High performance line receivers
- High fidelity active filters

Typical Application

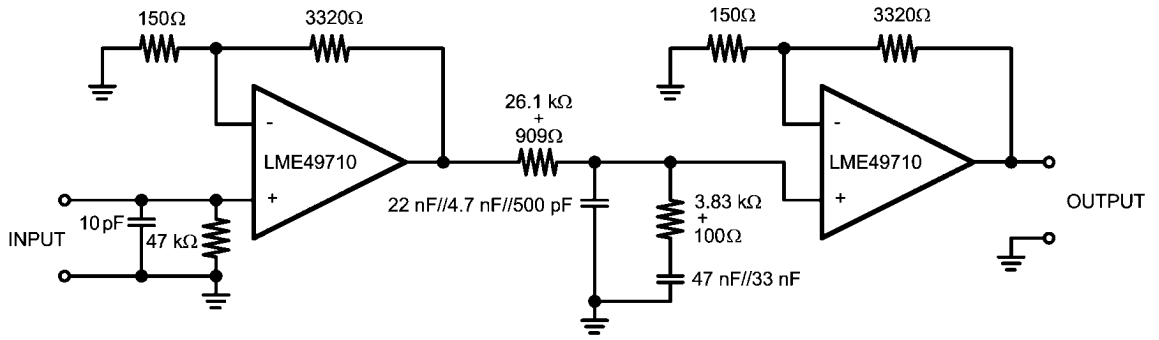

Note: 1% metal film resistors, 5% polypropylene capacitors

20210406

FIGURE 1. Passively Equalized RIAA Phono Preamp

Connection Diagrams

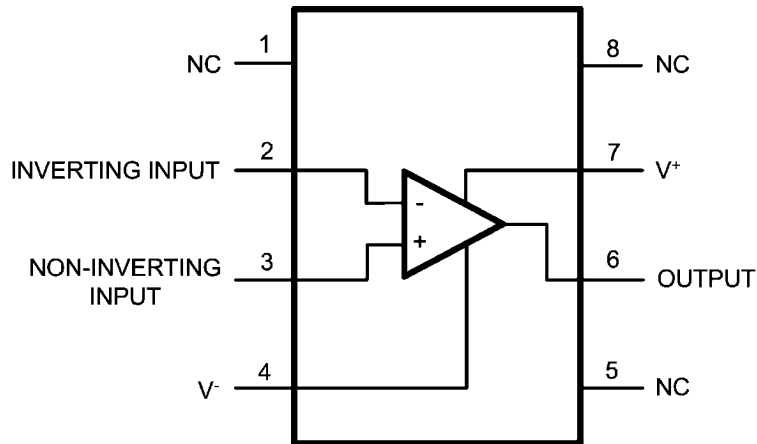

20210402

Order Number LME49710MA
 See NS Package Number — M08A
 Order Number LME49710NA
 See NS Package Number — N08E

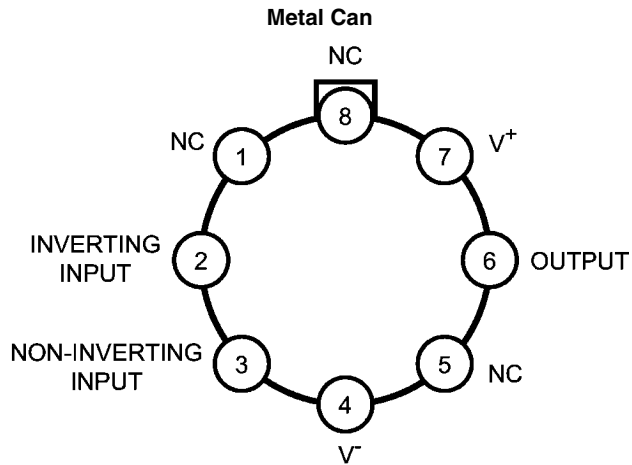

20210405

Order Number LME49710HA
 See NS Package Number — H08C

Absolute Maximum Ratings (Notes 1, 2)

If Military/Aerospace specified devices are required, please contact the National Semiconductor Sales Office/ Distributors for availability and specifications.

| | |
|---|----------------------------|
| Power Supply Voltage ($V_S = V^+ - V^-$) | 36V |
| Storage Temperature | -65°C to 150°C |
| Input Voltage | (V-) - 0.7V to (V+) + 0.7V |
| Output Short Circuit (Note 3) | Continuous |
| Power Dissipation | Internally Limited |
| ESD Susceptibility (Note 4) | 2000V |

| | |
|---------------------------------|----------------------------------|
| ESD Susceptibility (Note 5) | 200V |
| Junction Temperature | 150°C |
| Thermal Resistance | |
| θ_{JA} (SO) | 145°C/W |
| θ_{JA} (NA) | 102°C/W |
| θ_{JA} (HA) | 150°C/W |
| θ_{JC} (HA) | 35°C/W |
| Temperature Range | |
| $T_{MIN} \leq T_A \leq T_{MAX}$ | -40°C \leq T_A \leq 85°C |
| Supply Voltage Range | $\pm 2.5V \leq V_S \leq \pm 17V$ |

Electrical Characteristics (Notes 1, 2)

The following specifications apply for $V_S = \pm 15V$, $R_L = 2k\Omega$, $f_{IN} = 1kHz$, and $T_A = 25^\circ C$, unless otherwise specified.

| Symbol | Parameter | Conditions | LME49710 | | Units (Limits) |
|-----------------------------|--|--|------------|--------------|------------------------------------|
| | | | Typical | Limit | |
| | | | (Note 6) | (Notes 7, 8) | |
| THD+N | Total Harmonic Distortion + Noise | $A_V = 1$, $V_{OUT} = 3V_{RMS}$ $R_L = 2k\Omega$ $R_L = 600\Omega$ | 0.00003 | 0.00009 | % (max) |
| | | | 0.00003 | | % (max) |
| IMD | Intermodulation Distortion | $A_V = 1$, $V_{OUT} = 3V_{RMS}$ Two-tone, 60Hz & 7kHz 4:1 | 0.00005 | | % (max) |
| GBWP | Gain Bandwidth Product | | 55 | 45 | MHz (min) |
| SR | Slew Rate | | ± 20 | ± 15 | V/ μs (min) |
| FPBW | Full Power Bandwidth | $V_{OUT} = 1V_{P-P}$, -3dB referenced to output magnitude at $f = 1kHz$ | 10 | | MHz |
| t_s | Settling time | $A_V = 1$, 10V step, $C_L = 100pF$ 0.1% error range | 1.2 | | μs |
| e_n | Equivalent Input Noise Voltage | $f_{BW} = 20Hz$ to 20kHz | 0.34 | 0.65 | μV_{RMS} |
| | Equivalent Input Noise Density | $f = 1kHz$ $f = 10Hz$ | 2.5 6.4 | 4.7 | nV/ \sqrt{Hz} nV/ \sqrt{Hz} |
| i_n | Current Noise Density | $f = 1kHz$ $f = 10Hz$ | 1.6 | | pA/ \sqrt{Hz} |
| | | | 3.1 | | pA/ \sqrt{Hz} |
| V_{OS} | Offset Voltage | | ± 0.05 | ± 0.7 | mV (max) |
| $\Delta V_{OS}/\Delta Temp$ | Average Input Offset Voltage Drift vs Temperature | $40^\circ C \leq T_A \leq 85^\circ C$ | 0.2 | | $\mu V/^\circ C$ |
| PSRR | Average Input Offset Voltage Shift vs Power Supply Voltage | $\Delta V_S = 20V$ (Note 9) | 125 | 110 | dB (min) |
| I_B | Input Bias Current | $V_{CM} = 0V$ | 7 | 72 | nA (max) |
| $\Delta I_{OS}/\Delta Temp$ | Input Bias Current Drift vs Temperature | $-40^\circ C \leq T_A \leq 85^\circ C$ | 0.1 | | nA/ $^\circ C$ |
| I_{OS} | Input Offset Current | $V_{CM} = 0V$ | 5 | 65 | nA (max) |
| V_{IN-CM} | Common-Mode Input Voltage Range | | +14.1 | (V+) - 2.0 | V (min) |
| | | | -13.9 | (V-) + 2.0 | V (min) |
| CMRR | Common-Mode Rejection | $-10V < V_{CM} < 10V$ | 120 | 110 | dB (min) |
| Z_{IN} | Differential Input Impedance | | 30 | | k Ω |
| | Common Mode Input Impedance | $-10V < V_{CM} < 10V$ | 1000 | | M Ω |
| A_{VOL} | Open Loop Voltage Gain | $-10V < V_{OUT} < 10V$, $R_L = 600\Omega$ | 140 | | dB |
| | | $-10V < V_{OUT} < 10V$, $R_L = 2k\Omega$ | 140 | 125 | dB |
| | | $-10V < V_{OUT} < 10V$, $R_L = 10k\Omega$ | 140 | | dB |

| Symbol | Parameter | Conditions | LME49710 | | Units (Limits) |
|--------------|---------------------------------|----------------------------------|------------|--------------|-------------------|
| | | | Typical | Limit | |
| | | | (Note 6) | (Notes 7, 8) | |
| V_{OUTMAX} | Maximum Output Voltage Swing | $R_L = 600\Omega$ | ± 13.6 | ± 12.5 | V |
| | | $R_L = 2k\Omega$ | ± 14.0 | | V |
| | | $R_L = 10k\Omega$ | ± 14.1 | | V |
| I_{OUT} | Output Current | $R_L = 600\Omega, V_S = \pm 17V$ | ± 26 | ± 23 | mA (min) |
| I_{OUT-CC} | Short Circuit Current | | +53 -42 | | mA mA |
| R_{OUT} | Output Impedance | $f_{IN} = 10kHz$ Closed-Loop | 0.01 | | Ω |
| | | Open-Loop | 13 | | Ω |
| C_{LOAD} | Capacitive Load Drive Overshoot | 100pF | 16 | | % |
| I_S | Quiescent Current | $I_{OUT} = 0mA$ | 4.8 | 5.5 | mA (max) |

Note 1: Absolute Maximum Ratings indicate limits beyond which damage to the device may occur.

Note 2: Operating Ratings indicate conditions for which the device is functional, but do not guarantee specific performance limits. For guaranteed specifications and test conditions, see the Electrical Characteristics. The guaranteed specifications apply only for the test conditions listed. Some performance characteristics may degrade when the device is not operated under the listed test conditions.

Note 3: Amplifier output connected to GND, any number of amplifiers within a package.

Note 4: Human body model, 100pF discharged through a 1.5k Ω resistor.

Note 5: Machine Model ESD test is covered by specification EIAJ IC-121-1981. A 200pF cap is charged to the specified voltage and then discharged directly into the IC with no external series resistor (resistance of discharge path must be under 50 Ω).

Note 6: Typical specifications are specified at +25°C and represent the most likely parametric norm.

Note 7: Tested limits are guaranteed to National's AOQL (Average Outgoing Quality Level).

Note 8: Datasheet min/max specification limits are guaranteed by design, test, or statistical analysis.

Note 9: PSRR is measured as follows: V_{OS} is measured at two supply voltages, $\pm 5V$ and $\pm 15V$. $PSRR = |20\log(\Delta V_{OS}/\Delta V_S)|$.

Typical Performance Characteristics

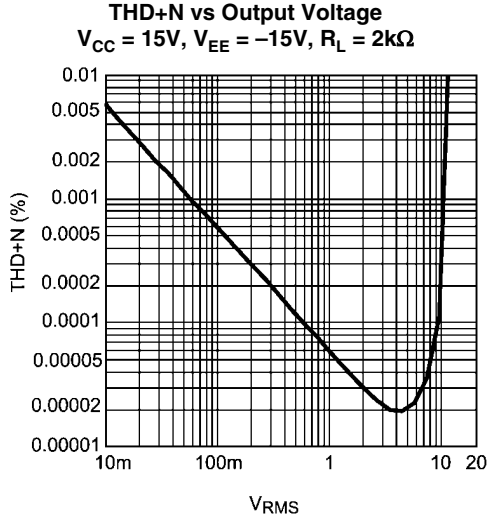

20210476

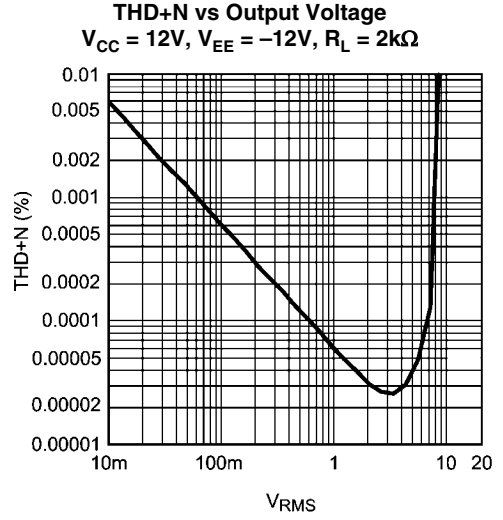

20210473

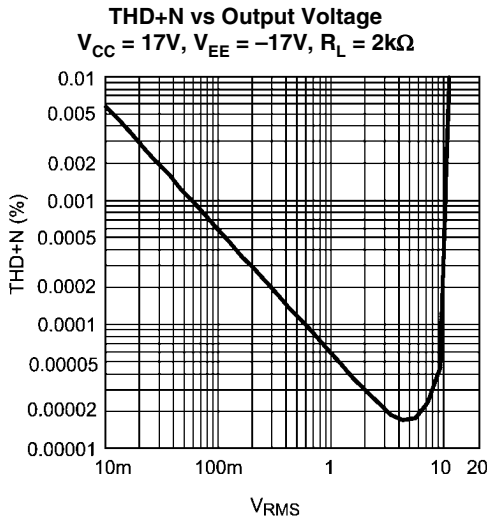

20210479

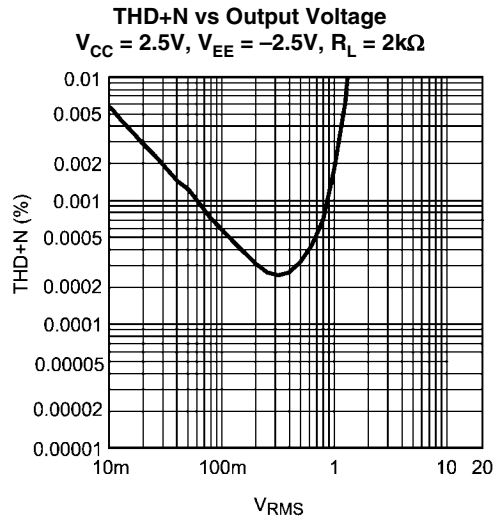

20210470

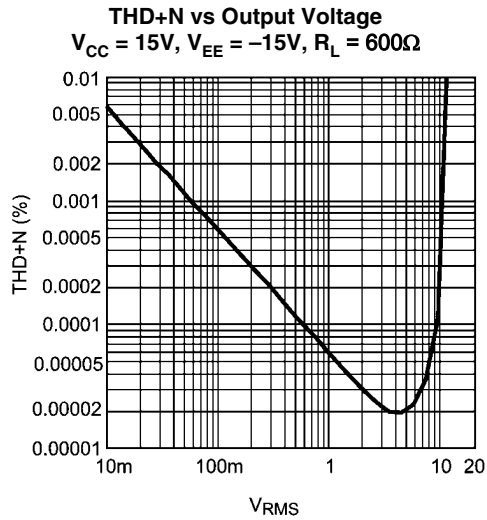

20210478

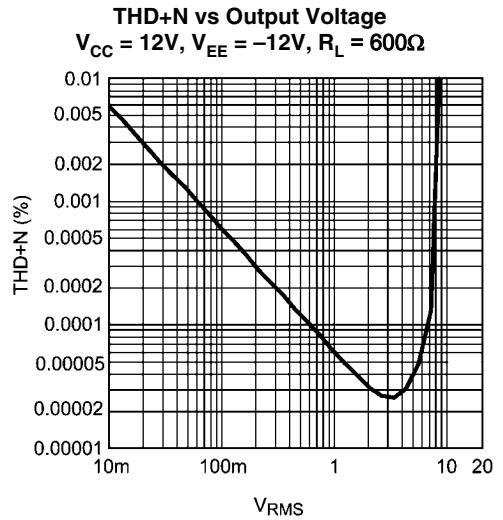

20210475

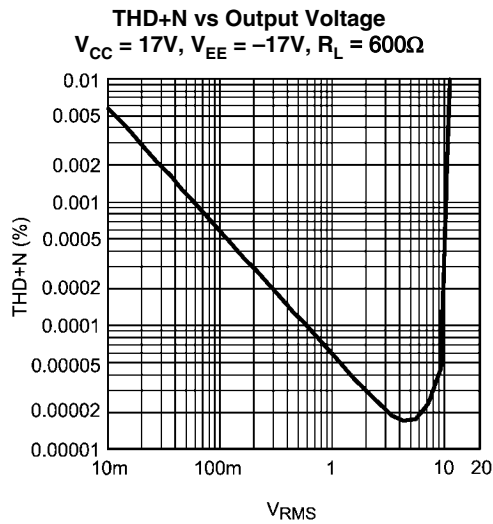

20210481

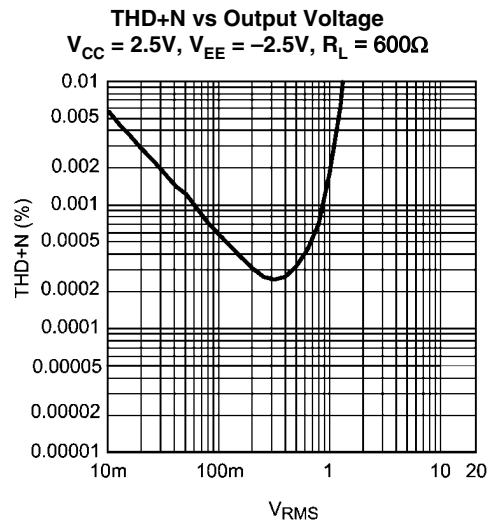

20210472

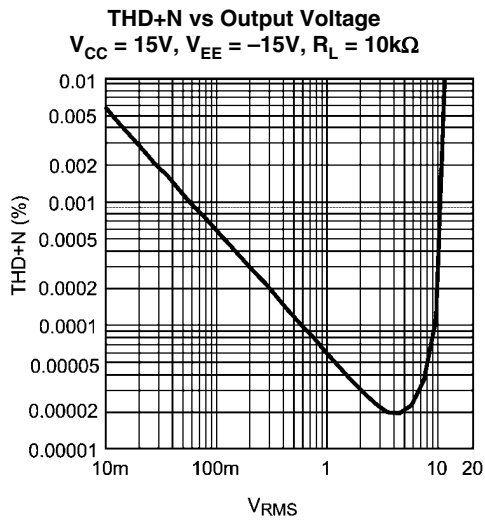

20210477

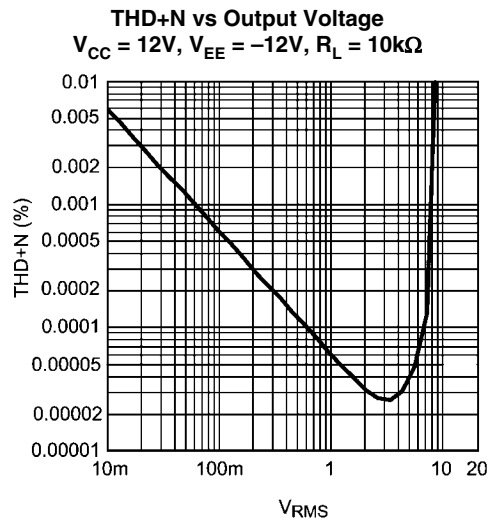

20210474

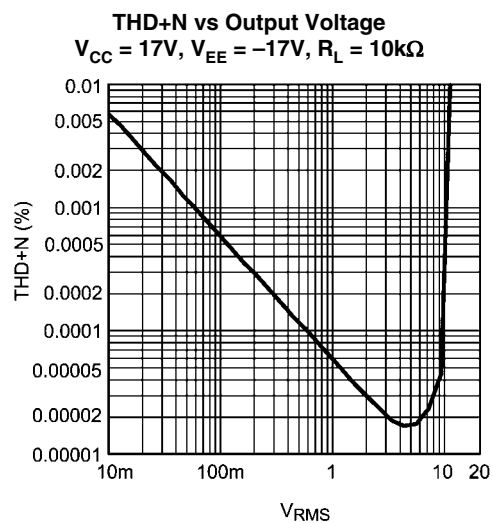

20210480

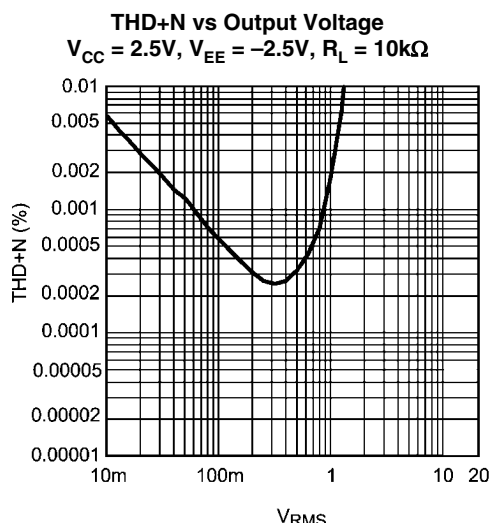

20210471

THD+N vs Frequency
 $V_{CC} = 15V, V_{EE} = -15V,$
 $R_L = 2k\Omega, V_{OUT} = 3V_{RMS}$

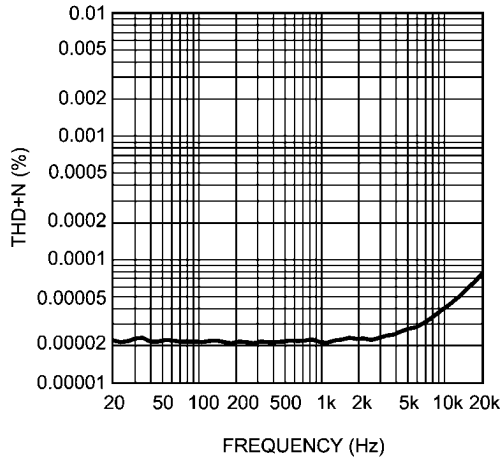

20210464

THD+N vs Frequency
 $V_{CC} = 17V, V_{EE} = -17V,$
 $R_L = 2k\Omega, V_{OUT} = 3V_{RMS}$

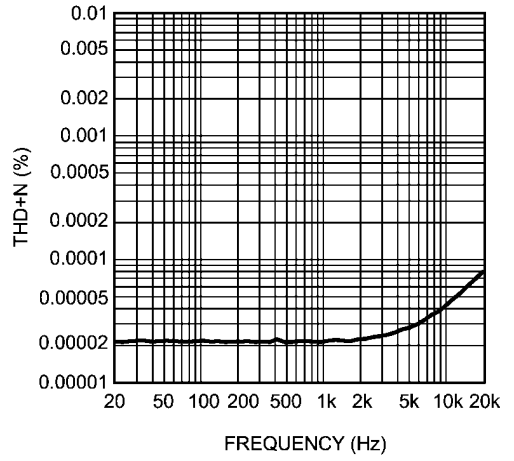

20210467

THD+N vs Frequency
 $V_{CC} = 15V, V_{EE} = -15V,$
 $R_L = 600\Omega, V_{OUT} = 3V_{RMS}$

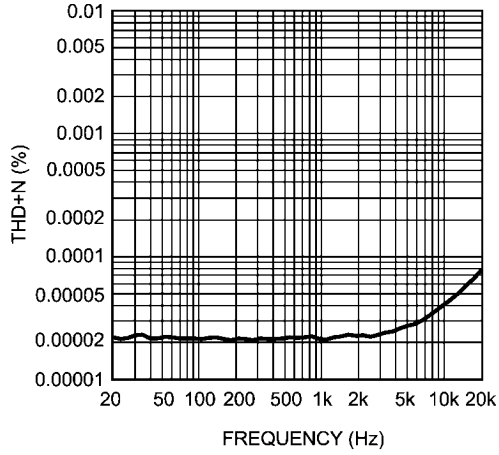

20210466

THD+N vs Frequency
 $V_{CC} = 17V, V_{EE} = -17V,$
 $R_L = 600\Omega, V_{OUT} = 3V_{RMS}$

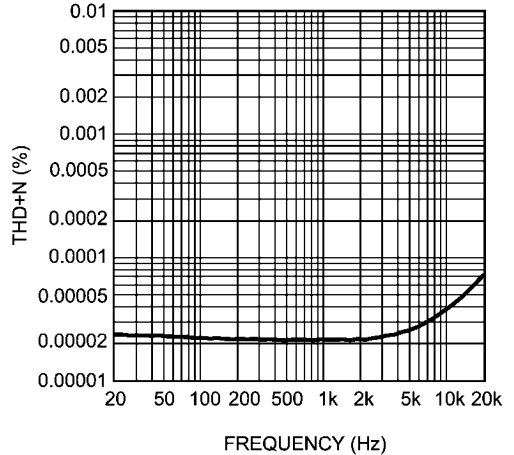

20210469

THD+N vs Frequency
 $V_{CC} = 15V, V_{EE} = -15V,$
 $R_L = 10k\Omega, V_{OUT} = 3V_{RMS}$

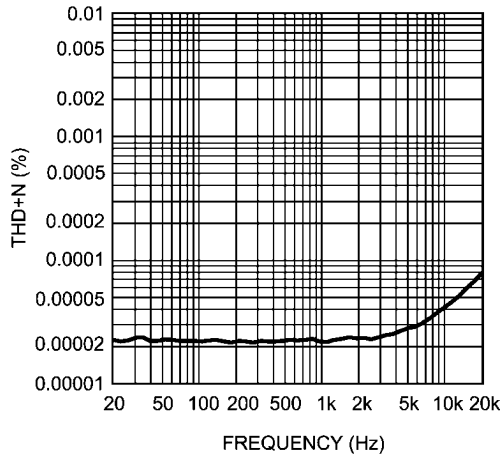

20210465

THD+N vs Frequency
 $V_{CC} = 17V, V_{EE} = -17V,$
 $R_L = 10k\Omega, V_{OUT} = 3V_{RMS}$

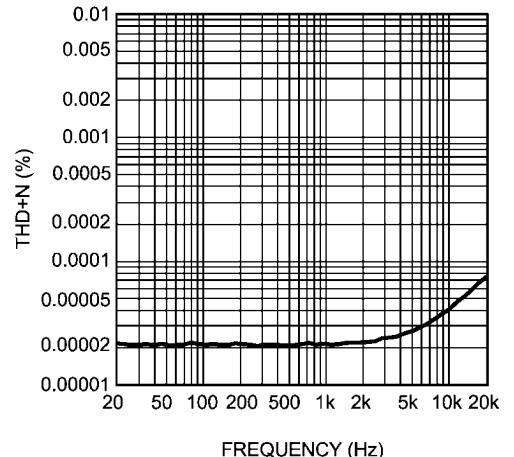

20210468

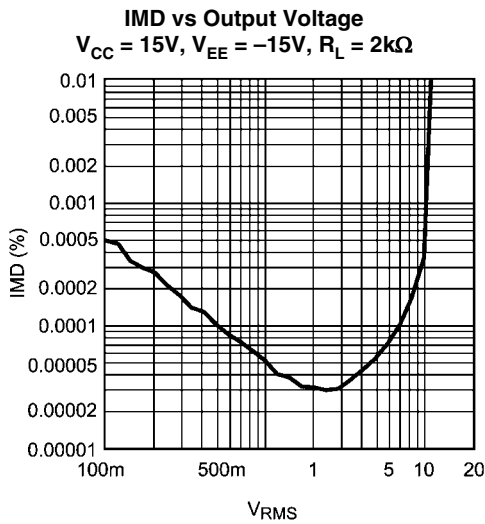

20210414

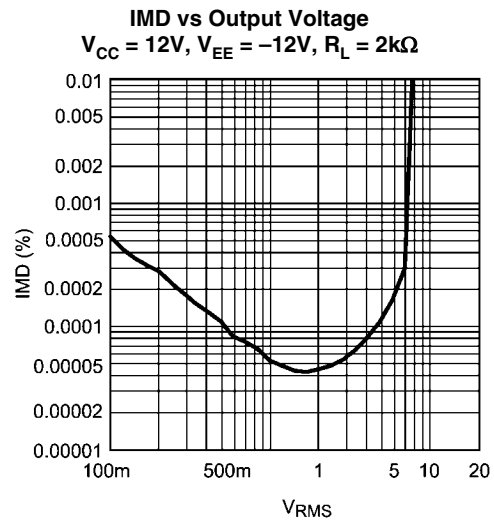

20210411

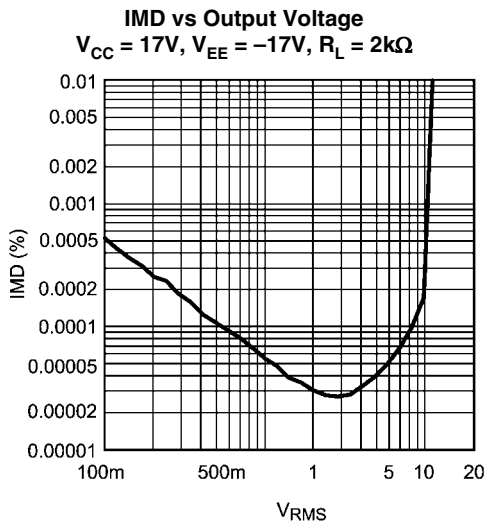

20210417

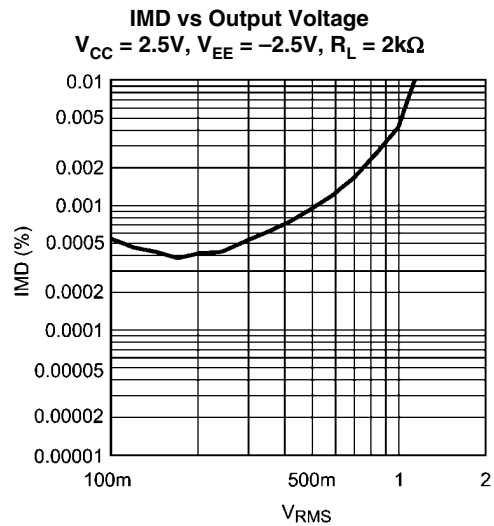

20210408

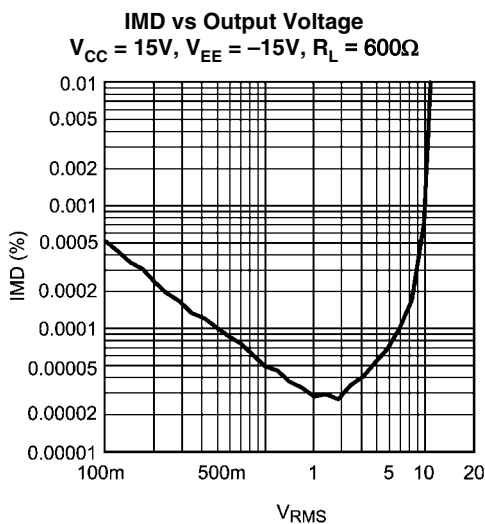

20210416

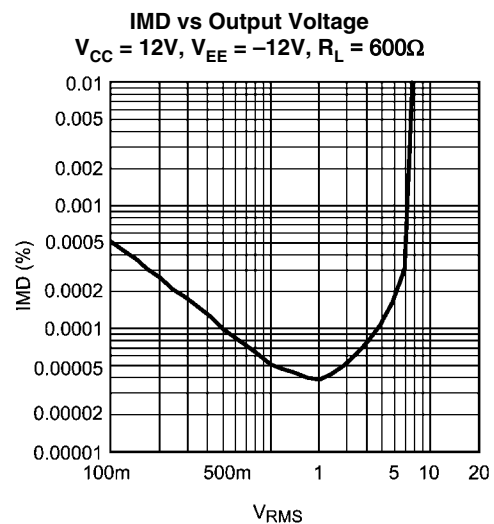

20210413

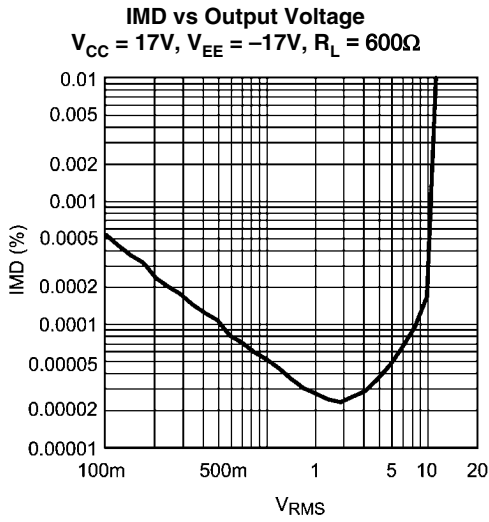

20210419

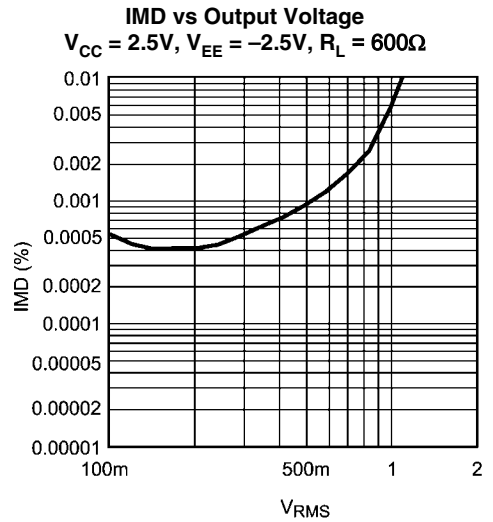

20210410

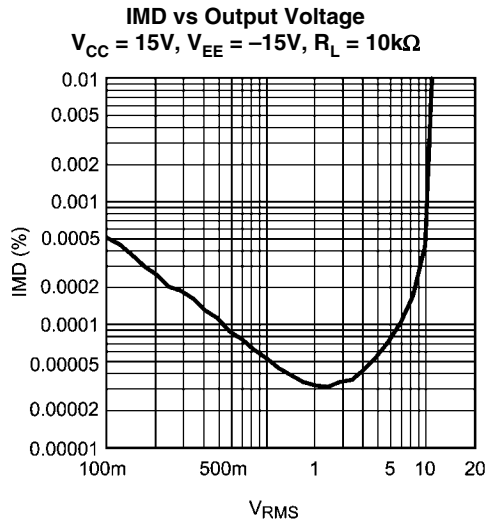

20210415

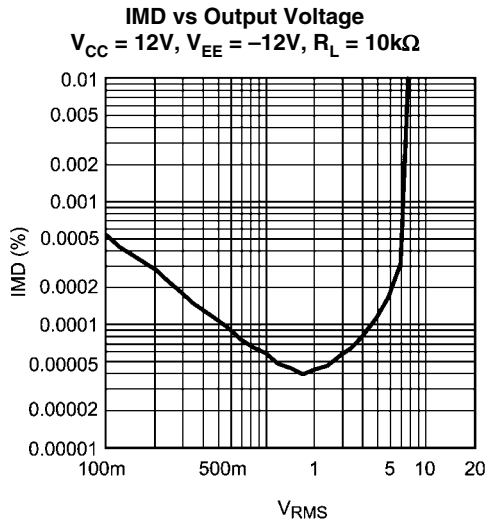

20210412

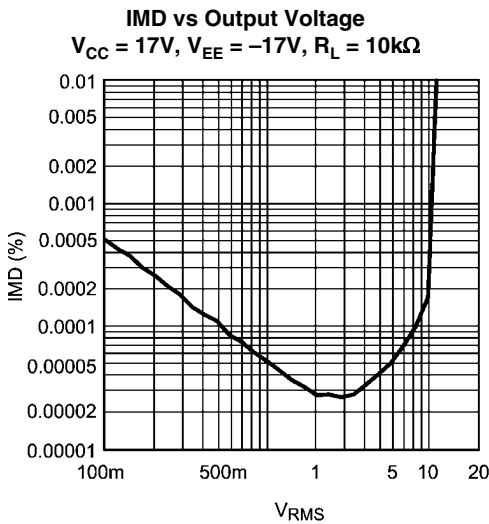

20210418

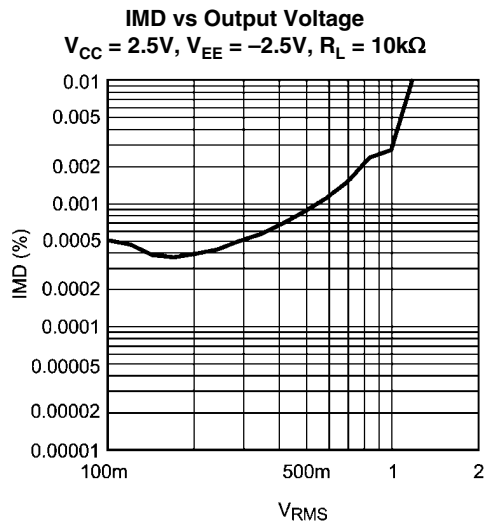

20210409

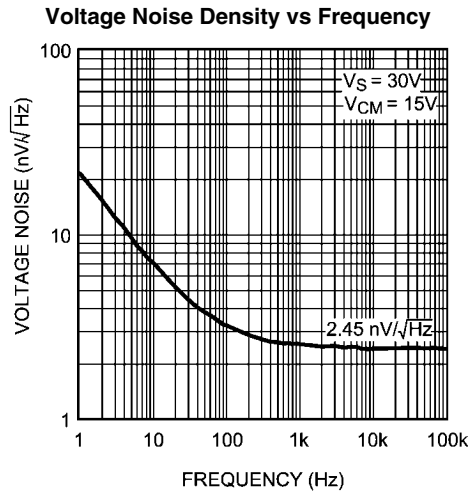

20210490

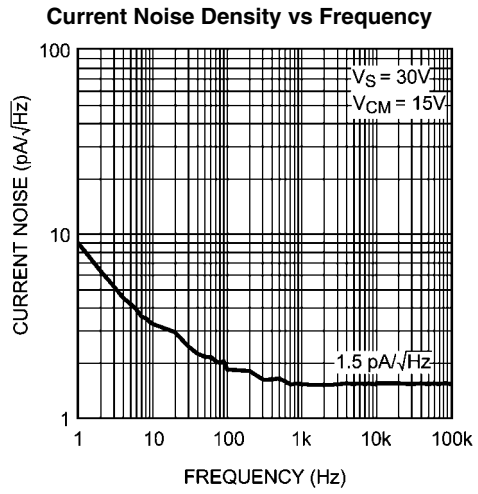

20210489

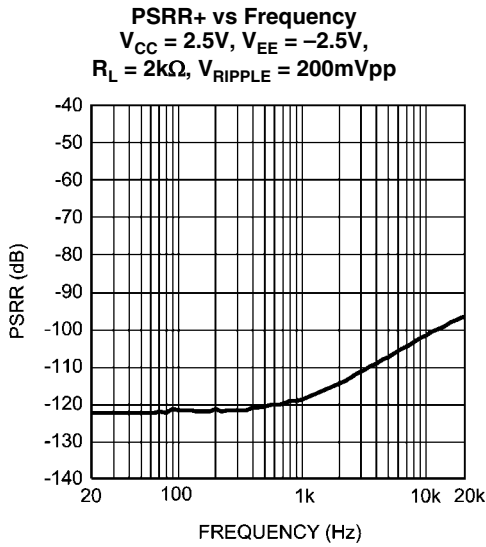

20210491

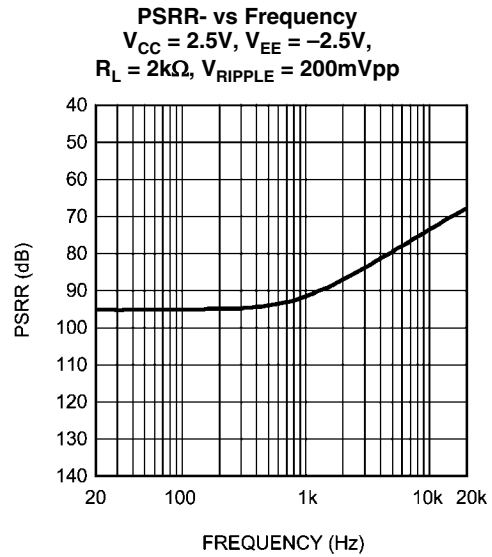

20210420

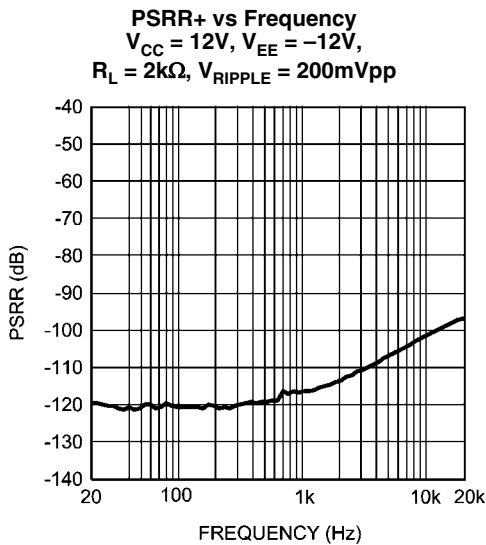

20210494

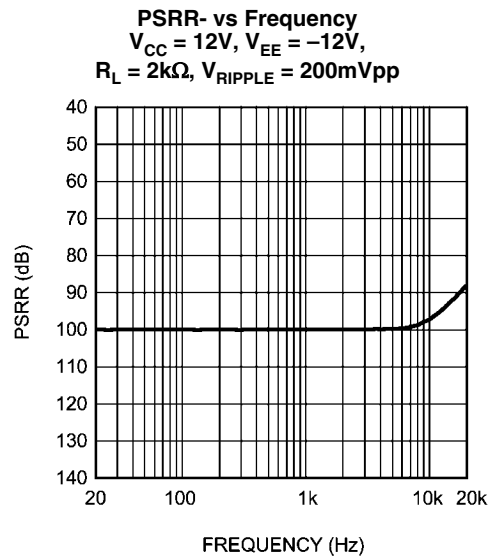

20210455

PSRR+ vs Frequency
 $V_{CC} = 15V, V_{EE} = -15V,$
 $R_L = 2k\Omega, V_{RIPPLE} = 200mV_{pp}$

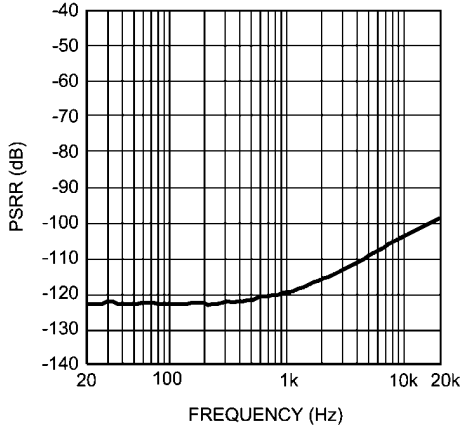

20210497

PSRR- vs Frequency
 $V_{CC} = 15V, V_{EE} = -15V,$
 $R_L = 2k\Omega, V_{RIPPLE} = 200mV_{pp}$

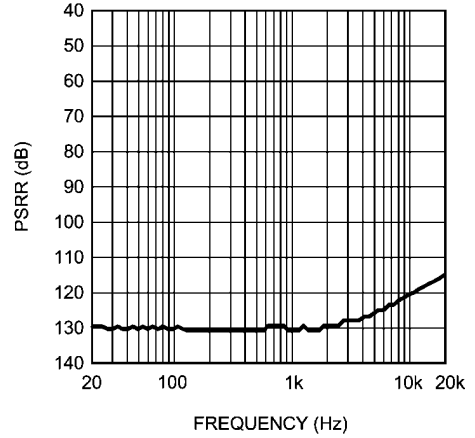

20210425

PSRR+ vs Frequency
 $V_{CC} = 17V, V_{EE} = -17V,$
 $R_L = 2k\Omega, V_{RIPPLE} = 200mV_{pp}$

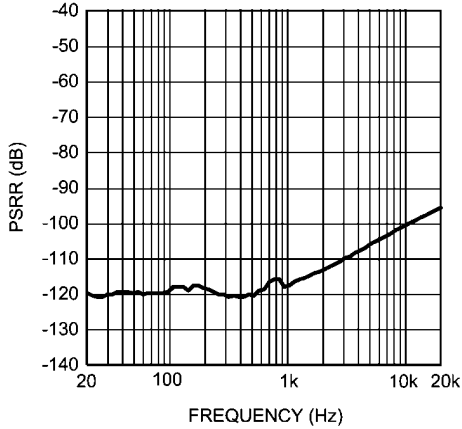

202104a0

PSRR- vs Frequency
 $V_{CC} = 17V, V_{EE} = -17V,$
 $R_L = 2k\Omega, V_{RIPPLE} = 200mV_{pp}$

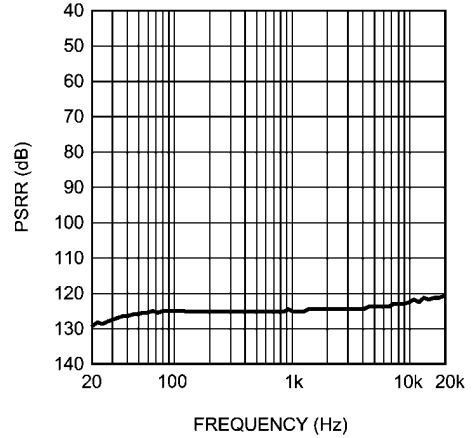

20210438

PSRR+ vs Frequency
 $V_{CC} = 2.5V, V_{EE} = -2.5V,$
 $R_L = 600\Omega, V_{RIPPLE} = 200mV_{pp}$

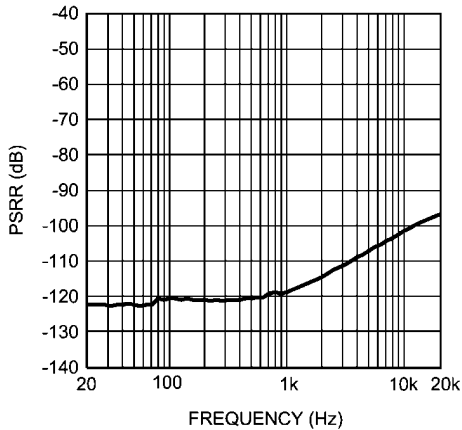

20210493

PSRR- vs Frequency
 $V_{CC} = 2.5V, V_{EE} = -2.5V,$
 $R_L = 600\Omega, V_{RIPPLE} = 200mV_{pp}$

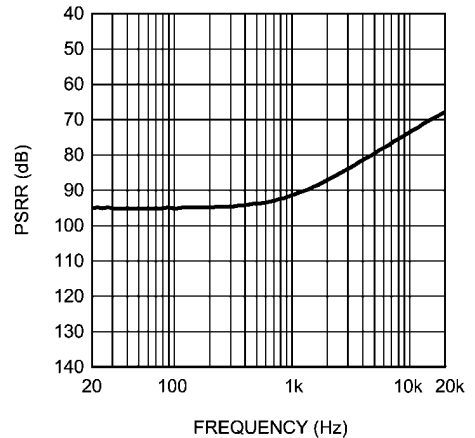

20210421

PSRR+ vs Frequency
 $V_{CC} = 12V, V_{EE} = -12V,$
 $R_L = 600\Omega, V_{RIPPLE} = 200mV_{pp}$

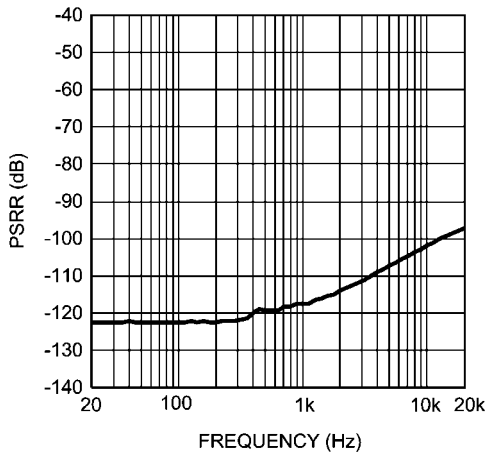

20210496

PSRR- vs Frequency
 $V_{CC} = 12V, V_{EE} = -12V,$
 $R_L = 600\Omega, V_{RIPPLE} = 200mV_{pp}$

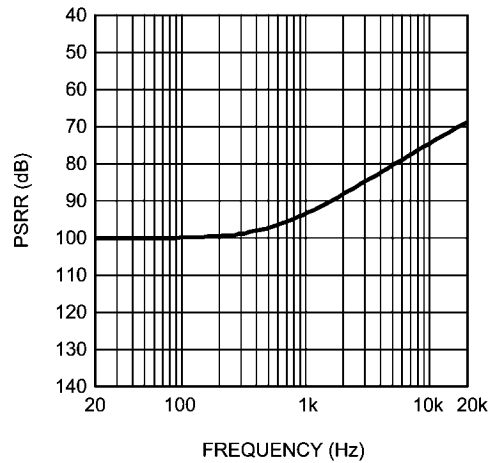

20210424

PSRR+ vs Frequency
 $V_{CC} = 15V, V_{EE} = -15V,$
 $R_L = 600\Omega, V_{RIPPLE} = 200mV_{pp}$

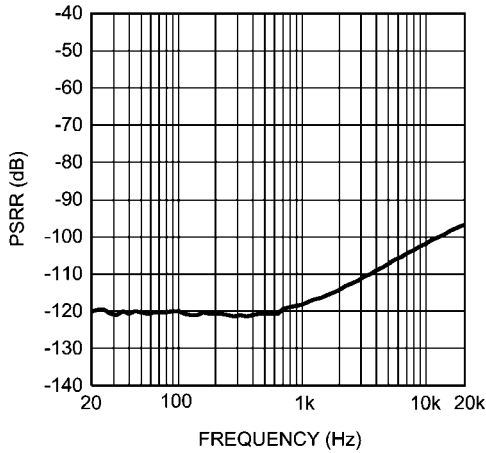

20210499

PSRR- vs Frequency
 $V_{CC} = 15V, V_{EE} = -15V,$
 $R_L = 600\Omega, V_{RIPPLE} = 200mV_{pp}$

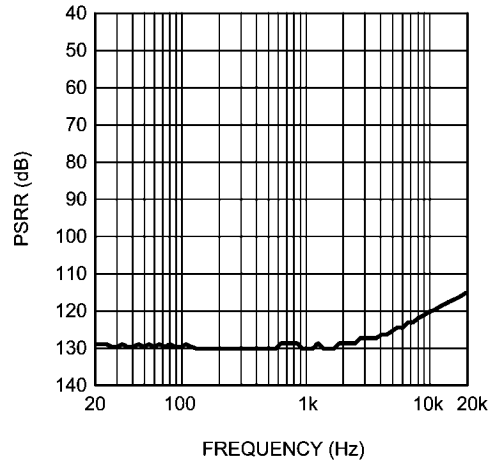

20210451

PSRR+ vs Frequency
 $V_{CC} = 17V, V_{EE} = -17V,$
 $R_L = 600\Omega, V_{RIPPLE} = 200mV_{pp}$

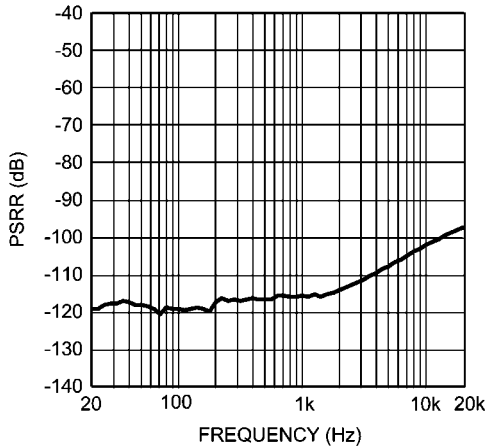

202104a2

PSRR- vs Frequency
 $V_{CC} = 17V, V_{EE} = -17V,$
 $R_L = 600\Omega, V_{RIPPLE} = 200mV_{pp}$

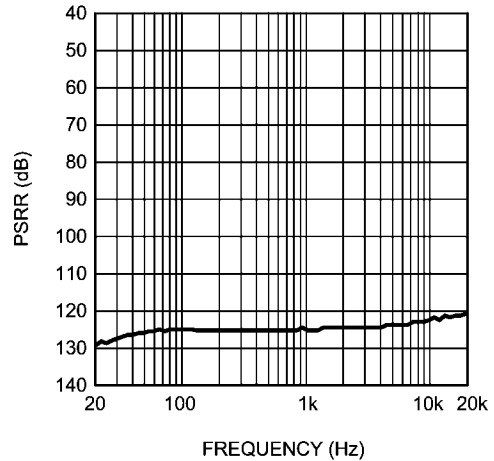

20210444

PSRR+ vs Frequency
 $V_{CC} = 2.5V, V_{EE} = -2.5V,$
 $R_L = 10k\Omega, V_{RIPPLE} = 200mV_{pp}$

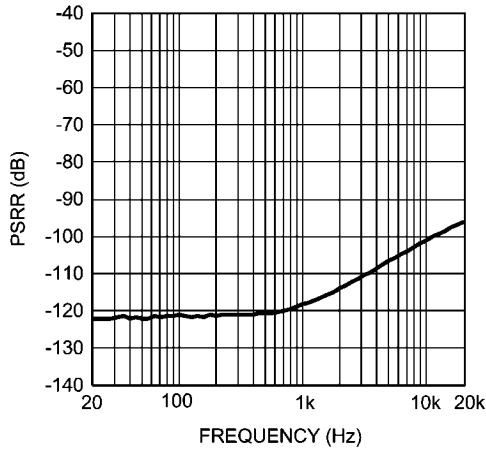

20210492

PSRR- vs Frequency
 $V_{CC} = 2.5V, V_{EE} = -2.5V,$
 $R_L = 10k\Omega, V_{RIPPLE} = 200mV_{pp}$

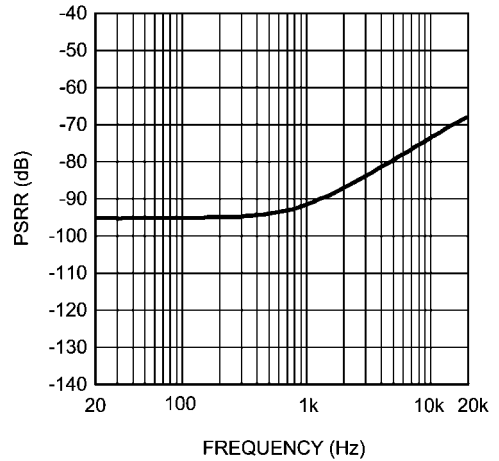

20210488

PSRR+ vs Frequency
 $V_{CC} = 12V, V_{EE} = -12V,$
 $R_L = 10k\Omega, V_{RIPPLE} = 200mV_{pp}$

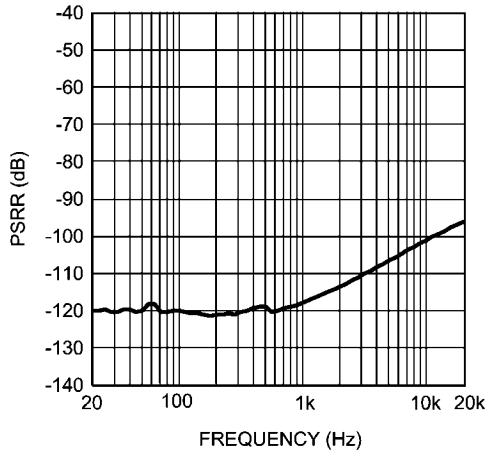

20210495

PSRR- vs Frequency
 $V_{CC} = 12V, V_{EE} = -12V,$
 $R_L = 10k\Omega, V_{RIPPLE} = 200mV_{pp}$

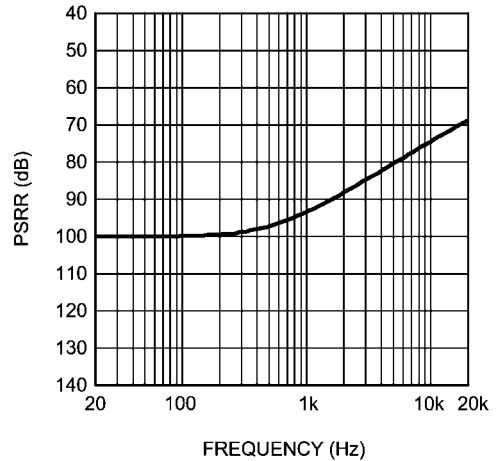

20210423

PSRR+ vs Frequency
 $V_{CC} = 15V, V_{EE} = -15V,$
 $R_L = 10k\Omega, V_{RIPPLE} = 200mV_{pp}$

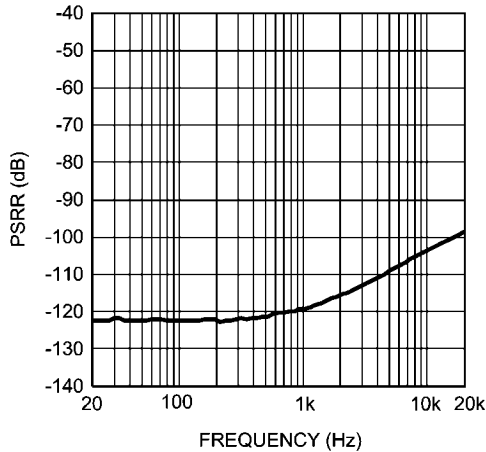

20210498

PSRR- vs Frequency
 $V_{CC} = 15V, V_{EE} = -15V,$
 $R_L = 10k\Omega, V_{RIPPLE} = 200mV_{pp}$

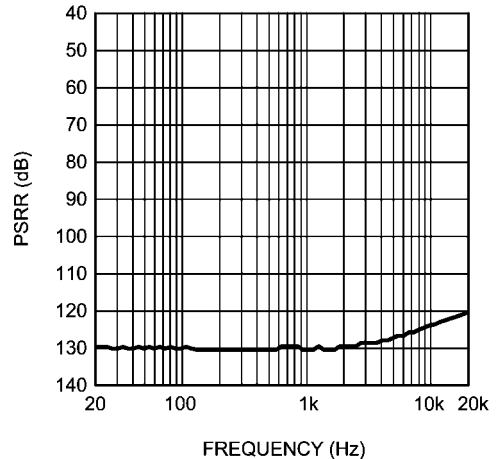

20210426

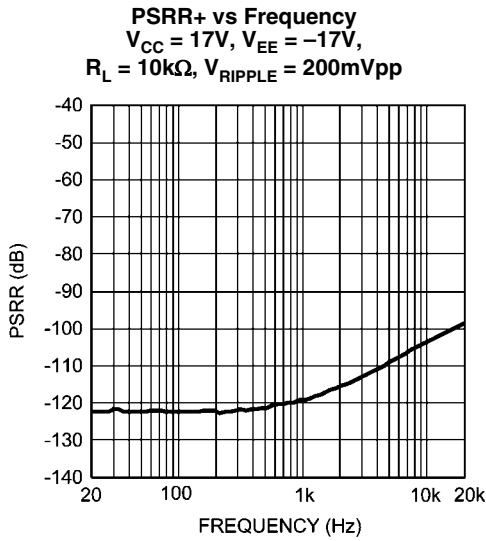

202104a1

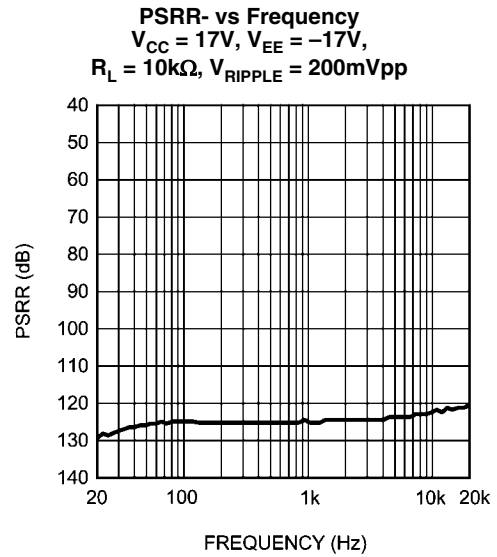

20210439

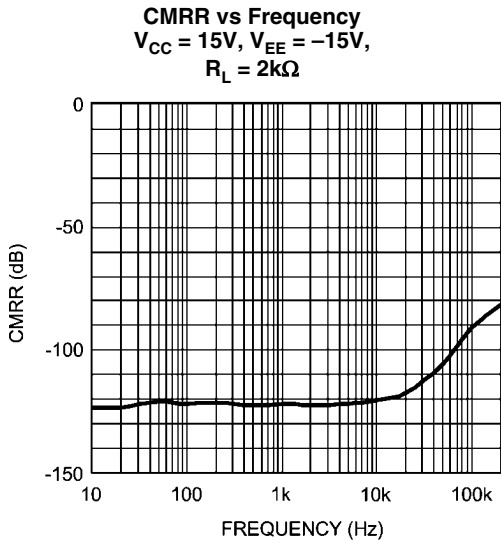

202104b1

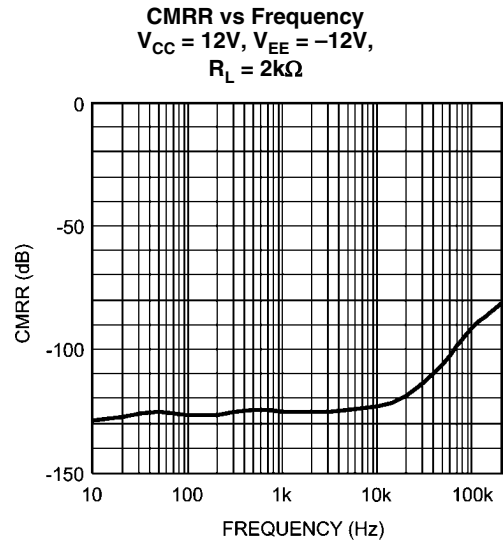

202104a8

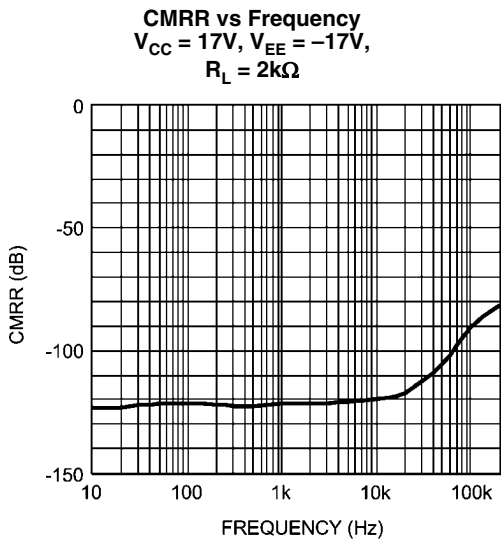

202104b4

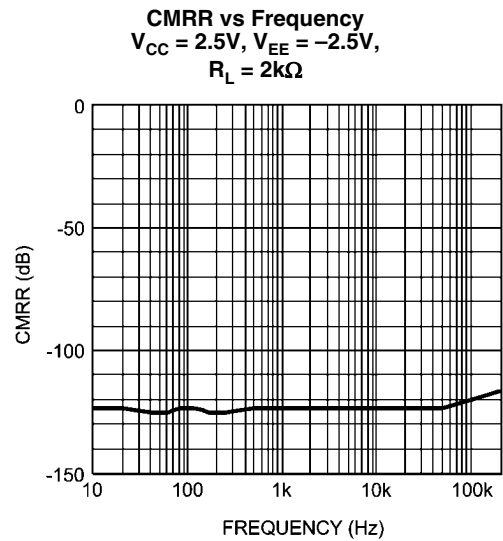

202104a5

CMRR vs Frequency
 $V_{CC} = 15V, V_{EE} = -15V,$
 $R_L = 600\Omega$

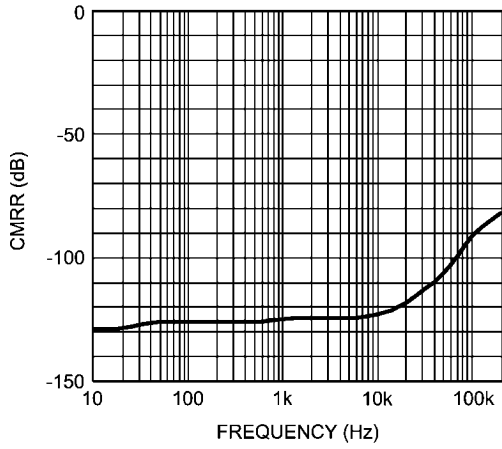

202104b3

CMRR vs Frequency
 $V_{CC} = 12V, V_{EE} = -12V,$
 $R_L = 600\Omega$

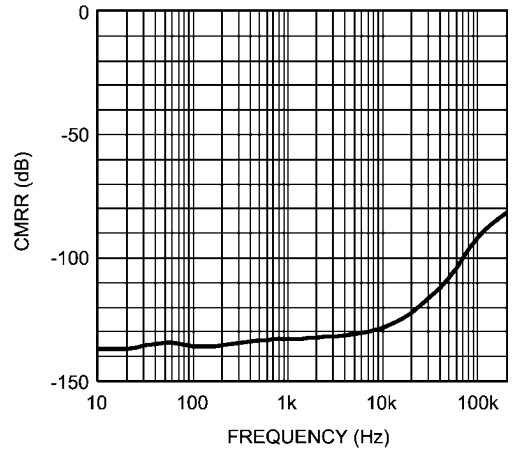

202104b0

CMRR vs Frequency
 $V_{CC} = 17V, V_{EE} = -17V,$
 $R_L = 600\Omega$

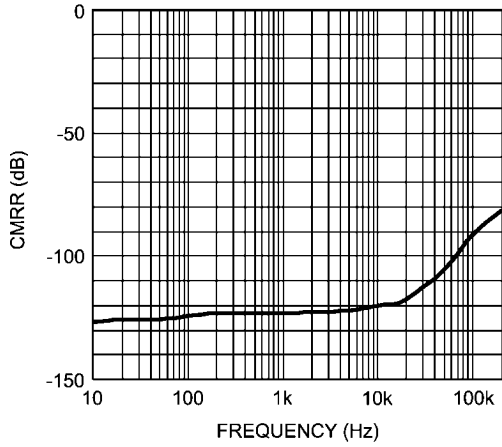

202104b6

CMRR vs Frequency
 $V_{CC} = 2.5V, V_{EE} = -2.5V,$
 $R_L = 600\Omega$

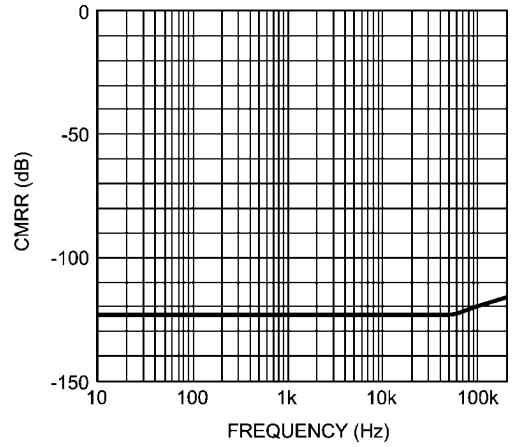

202104a7

CMRR vs Frequency
 $V_{CC} = 15V, V_{EE} = -15V,$
 $R_L = 10k\Omega$

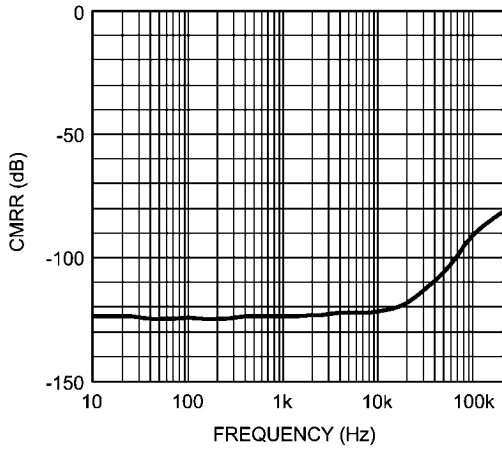

202104b2

CMRR vs Frequency
 $V_{CC} = 12V, V_{EE} = -12V,$
 $R_L = 10k\Omega$

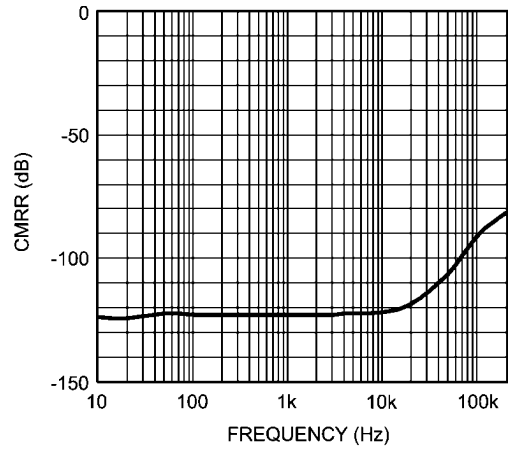

202104a9

CMRR vs Frequency
 $V_{CC} = 17V, V_{EE} = -17V,$
 $R_L = 10k\Omega$

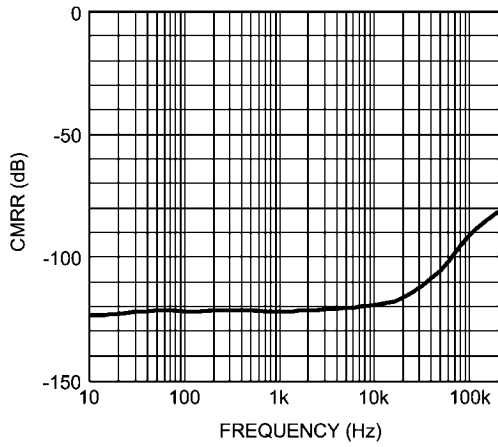

202104b5

CMRR vs Frequency
 $V_{CC} = 2.5V, V_{EE} = -2.5V,$
 $R_L = 10k\Omega$

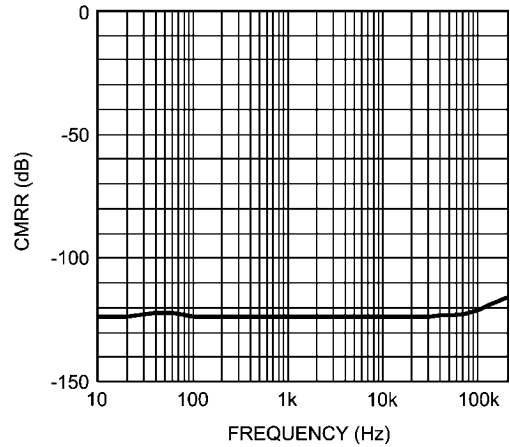

202104a6

Output Voltage vs Supply Voltage
 $R_L = 2k\Omega, THD+N = 1\%$

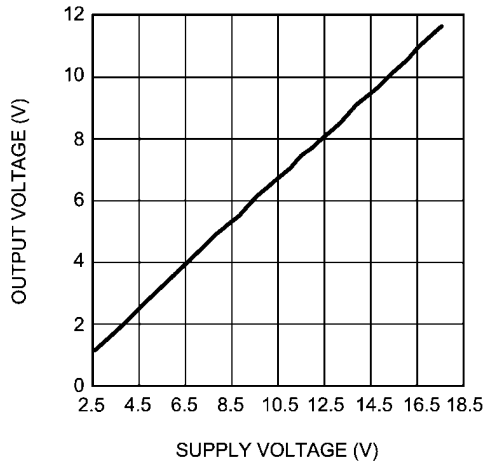

20210485

Output Voltage vs Supply Voltage
 $R_L = 600\Omega, THD+N = 1\%$

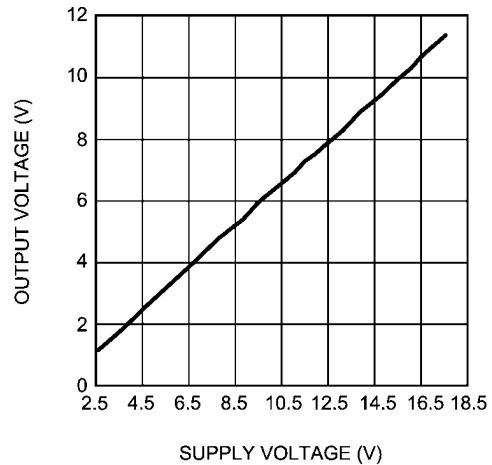

20210487

Output Voltage vs Supply Voltage
 $R_L = 10k\Omega, THD+N = 1\%$

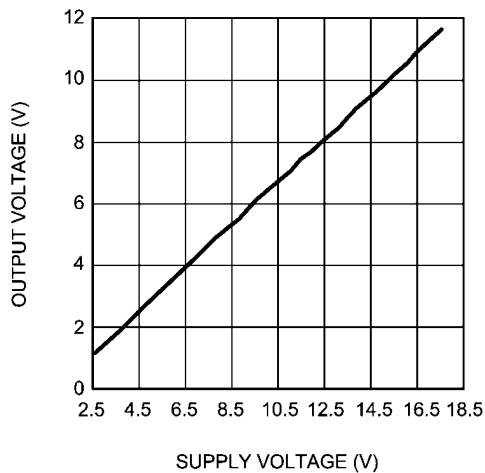

20210486

Output Voltage vs Load Resistance
 $V_{CC} = 15V, V_{EE} = -15V, THD+N = 1\%$

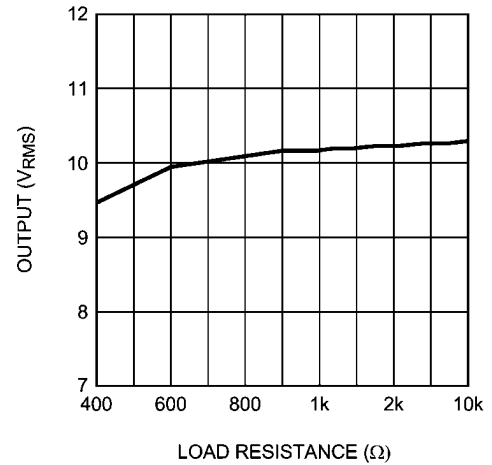

20210483

Output Voltage vs Load Resistance
 $V_{CC} = 17V, V_{EE} = -17V, THD+N = 1\%$

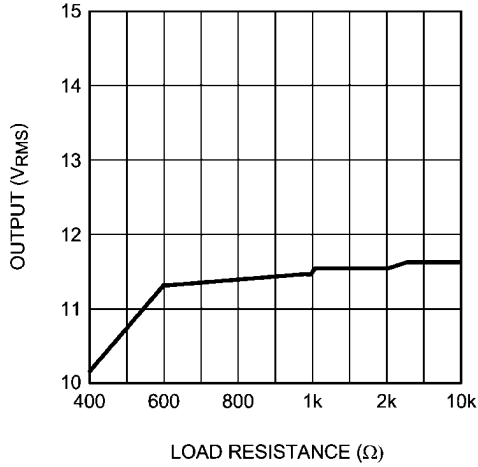

20210484

Output Voltage vs Load Resistance
 $V_{CC} = 2.5V, V_{EE} = -2.5V, THD+N = 1\%$

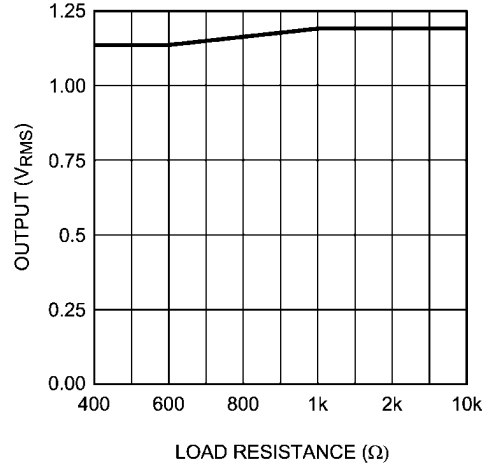

20210482

Small-Signal Transient Response
 $A_V = -1, C_L = 100pF$

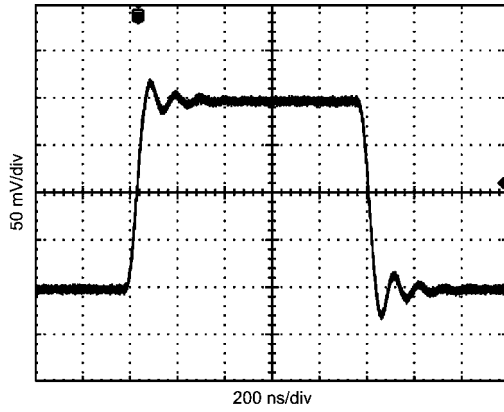

202104a4

Large-Signal Transient Response
 $A_V = -1, C_L = 100pF$

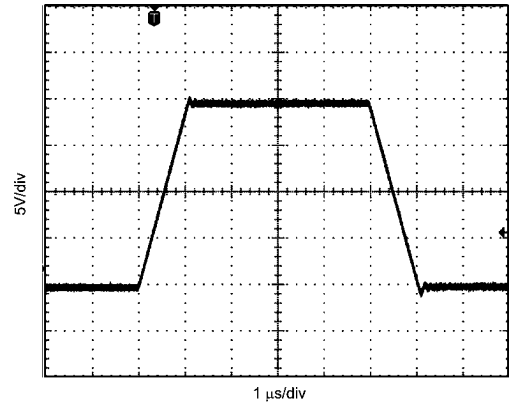

202104a3

Application Hints

The LME49710 is a high speed op amp with excellent phase margin and stability. Capacitive loads up to 100pF will cause little change in the phase characteristics of the amplifiers and are therefore allowable.

Capacitive loads greater than 100pF must be isolated from the output. The most straight forward way to do this is to put a resistor in series with the output. This resistor will also prevent excess power dissipation if the output is accidentally shorted.

Noise Measurement Circuit

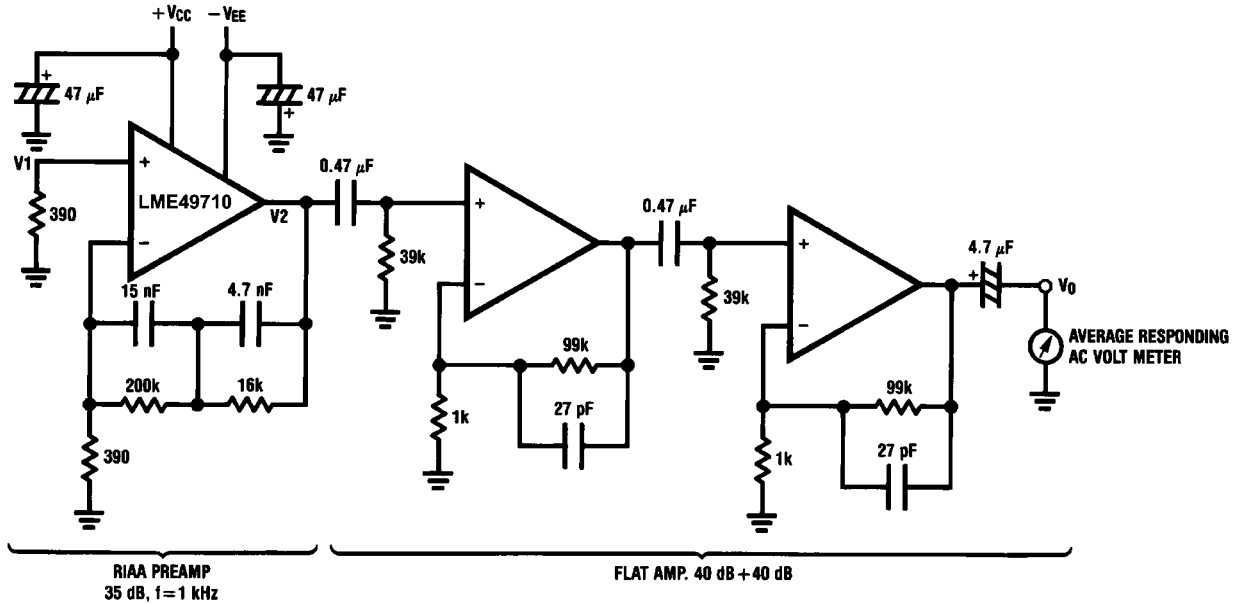

Complete shielding is required to prevent induced pick up from external sources. Always check with oscilloscope for power line noise.

20210427

Total Gain: 115 dB at f = 1 kHz
Input Referred Noise Voltage: $e_n = V_o / 560,000$ (V)

RIAA Preamp Voltage Gain
RIAA Deviation vs Frequency
 $V_{IN} = 10mV, A_V = 35.0dB, f = 1kHz$

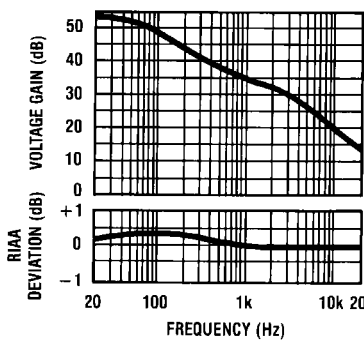

20210428

Flat Amp Voltage Gain vs Frequency
 $V_o = 0dB, A_V = 80.0dB, f = 1kHz$

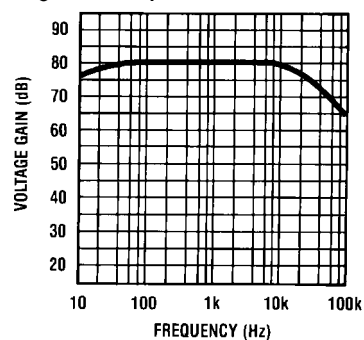

20210429

Typical Applications

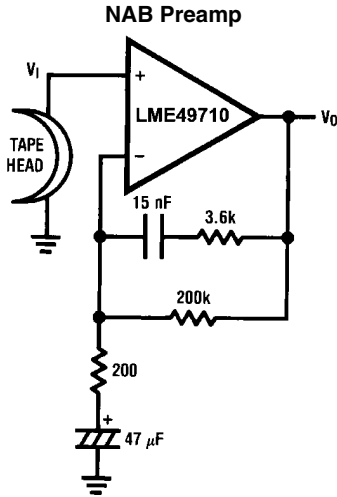

NAB Preamp Voltage Gain vs Frequency
 $V_{IN} = 10mV, 34.5dB, f = 1kHz$

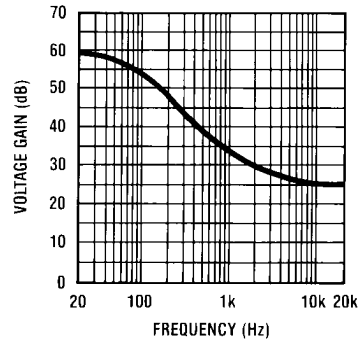

20210431

$A_V = 34.5$
 $F = 1 \text{ kHz}$
 $E_n = 0.38 \mu V$
 A Weighted

20210430

Balanced to Single Ended Converter

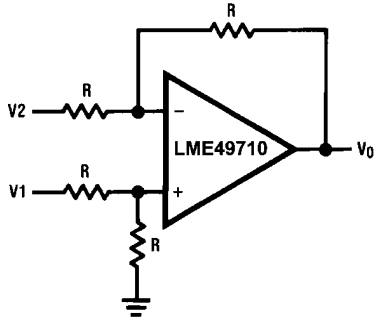

$V_O = V1 - V2$

20210432

Adder/Subtractor

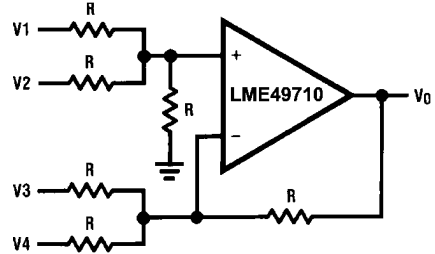

$V_O = V1 + V2 - V3 - V4$

20210433

Sine Wave Oscillator

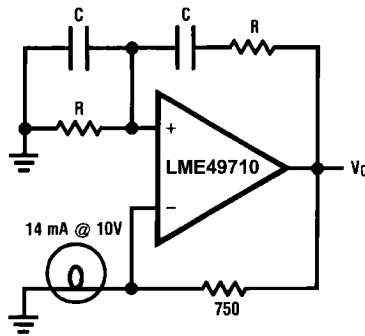

20210434

$f_o = \frac{1}{2\pi RC}$

Second Order High Pass Filter (Butterworth)

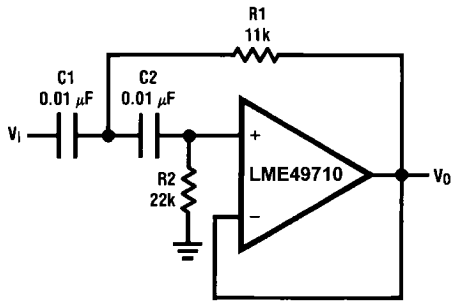

20210435

if $C1 = C2 = C$

$$R1 = \frac{\sqrt{2}}{2\omega_0 C}$$

$$R2 = 2 \cdot R1$$

Illustration is $f_0 = 1 \text{ kHz}$

Second Order Low Pass Filter (Butterworth)

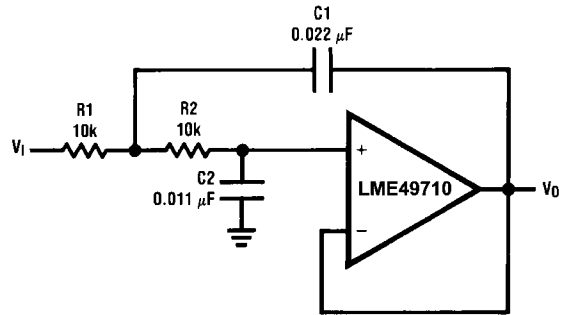

20210436

if $R1 = R2 = R$

$$C1 = \frac{\sqrt{2}}{\omega_0 R}$$

$$C2 = \frac{C1}{2}$$

Illustration is $f_0 = 1 \text{ kHz}$

State Variable Filter

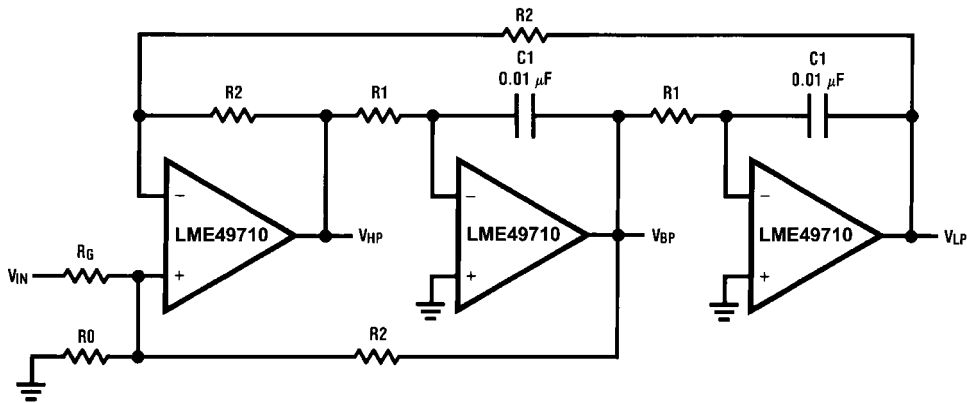

20210437

$$f_0 = \frac{1}{2\pi C1 R1}, Q = \frac{1}{2} \left(1 + \frac{R2}{R0} + \frac{R2}{RG} \right), A_{BP} = Q A_{LP} = Q A_{LH} = \frac{R2}{RG}$$

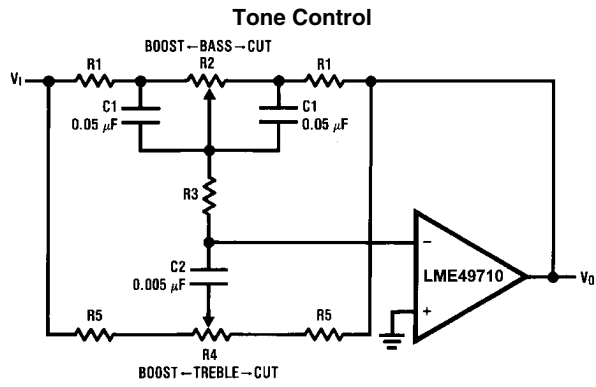
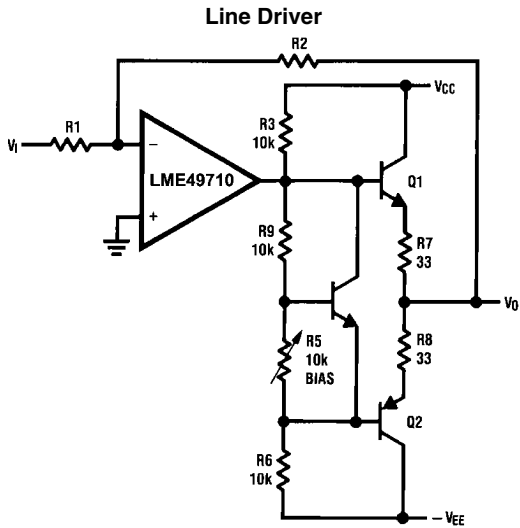

$$f_L = \frac{1}{2\pi R_2 C_1}, f_{LB} = \frac{1}{2\pi R_1 C_1}$$

$$f_H = \frac{1}{2\pi R_5 C_2}, f_{HB} = \frac{1}{2\pi(R_1 + R_5 + 2R_3)C_2}$$

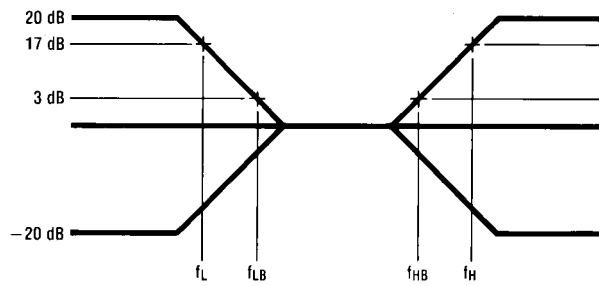

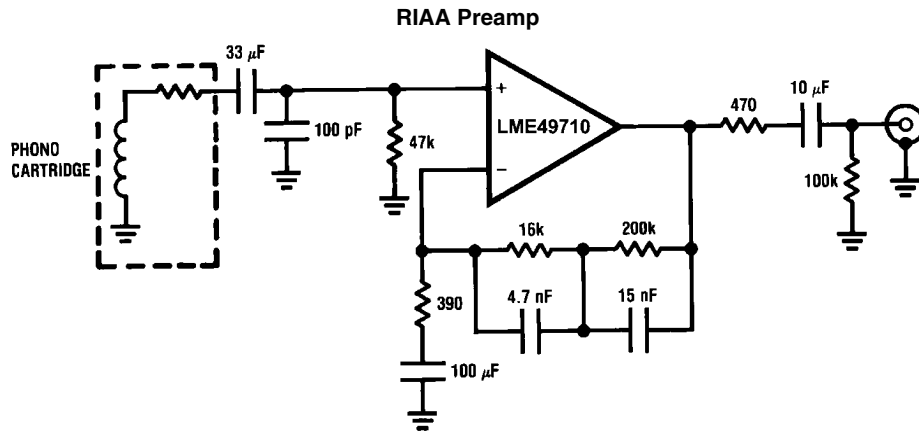

20210403

$A_v = 35 \text{ dB}$
 $E_n = 0.33 \mu\text{V}$
 $S/N = 90 \text{ dB}$
 $f = 1 \text{ kHz}$
 A Weighted
 A Weighted, $V_{IN} = 10 \text{ mV}$
 @ $f = 1 \text{ kHz}$

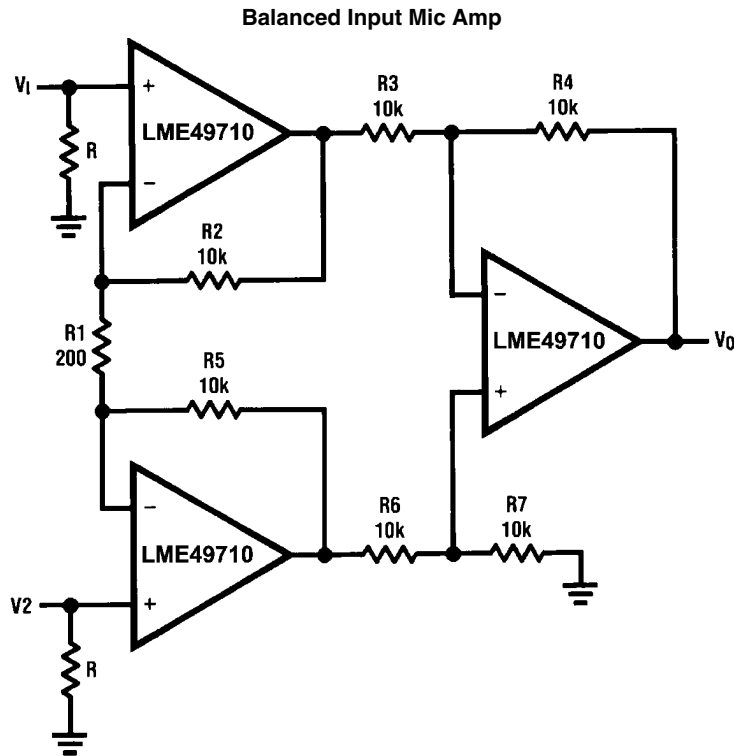

20210443

If $R_2 = R_5, R_3 = R_6, R_4 = R_7$

$$V_0 = \left(1 + \frac{2R_2}{R_1} \right) \frac{R_4}{R_3} (V_2 - V_1)$$

Illustration is:
 $V_0 = 101(V_2 - V_1)$

Application Information

DISTORTION MEASUREMENTS

The vanishingly low residual distortion produced by LME49710 is below the capabilities of all commercially available equipment. This makes distortion measurements just slightly more difficult than simply connecting a distortion meter to the amplifier's inputs and outputs. The solution, however, is quite simple: an additional resistor. Adding this resistor extends the resolution of the distortion measurement equipment.

The LME49710's low residual distortion is an input referred internal error. As shown in Figure 2, adding the 10Ω resistor connected between the amplifier's inverting and non-inverting

inputs changes the amplifier's noise gain. The result is that the error signal (distortion) is amplified by a factor of 101. Although the amplifier's closed-loop gain is unaltered, the feedback available to correct distortion errors is reduced by 101, which means that measurement resolution increases by 101. To ensure minimum effects on distortion measurements, keep the value of R1 low as shown in Figure 2.

This technique is verified by duplicating the measurements with high closed loop gain and/or making the measurements at high frequencies. Doing so produces distortion components that are within the measurement equipment's capabilities. This datasheet's THD+N and IMD values were generated using the above described circuit connected to an Audio Precision System Two Cascade.

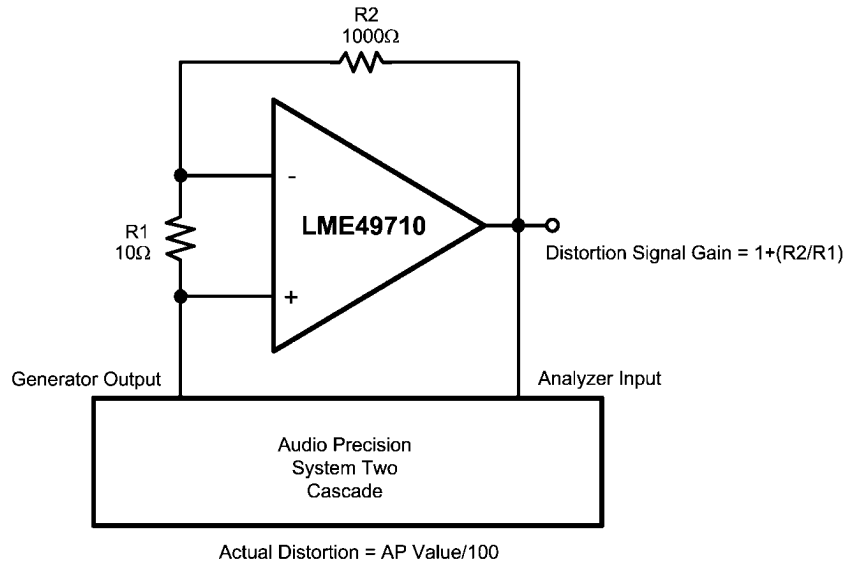

20210407

FIGURE 2. THD+N and IMD Distortion Test Circuit

Revision History

| Rev | Date | Description |
|-----|----------|--|
| 1.0 | 11/16/07 | Initial release. |
| 1.1 | 12/12/06 | Added the Typical Performance curves. |
| 1.2 | 01/15/07 | Added more curves and input some text edits. |
| 1.3 | 03/09/07 | Fixed graphics 20210489 and 90. |

Physical Dimensions inches (millimeters) unless otherwise noted

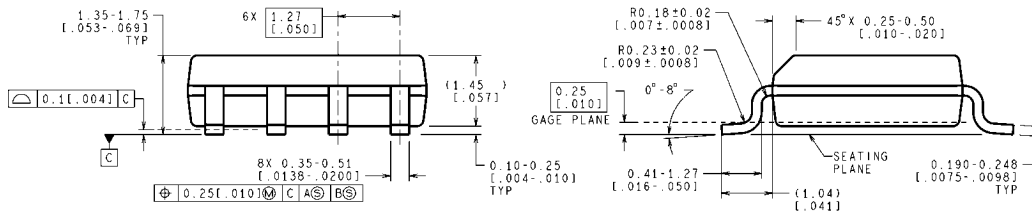
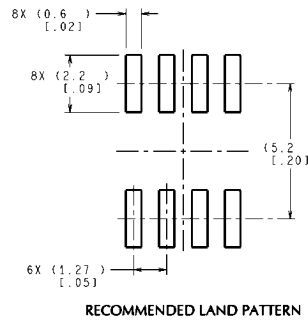
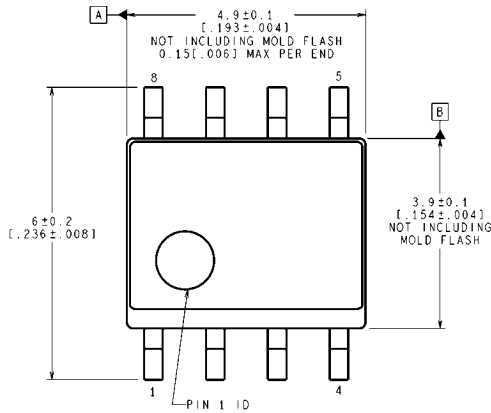

CONTROLLING DIMENSION IS MILLIMETER
VALUES IN [] ARE INCHES
DIMENSIONS IN () FOR REFERENCE ONLY

M08A (Rev L)

Dual-In-Line Package
Order Number LME49710MA
NS Package Number M08A

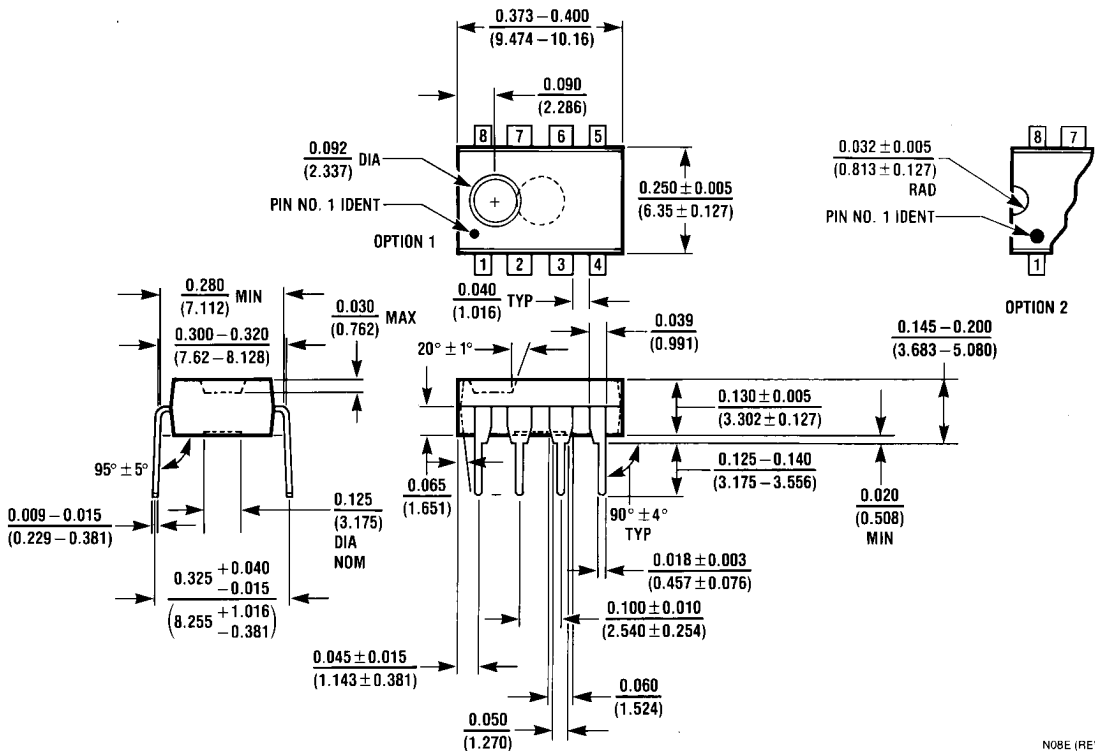

Dual-In-Line Package
Order Number LME49710NA
NS Package Number N08E

N08E (REV F)

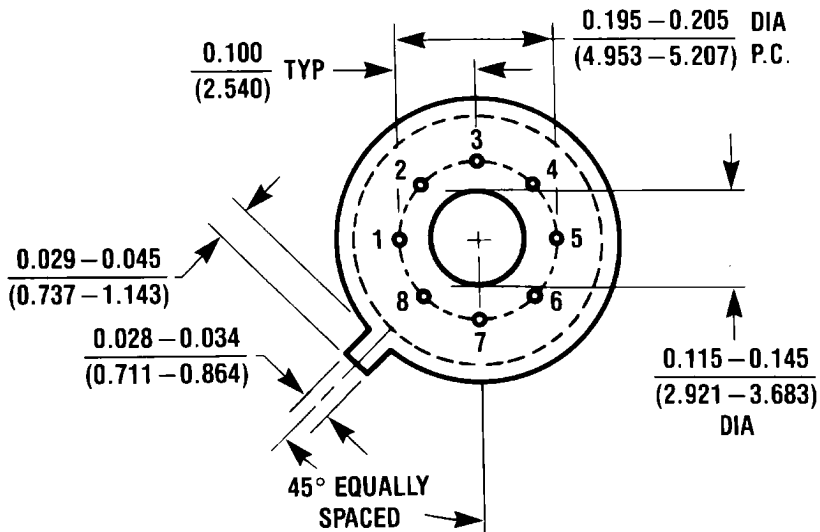
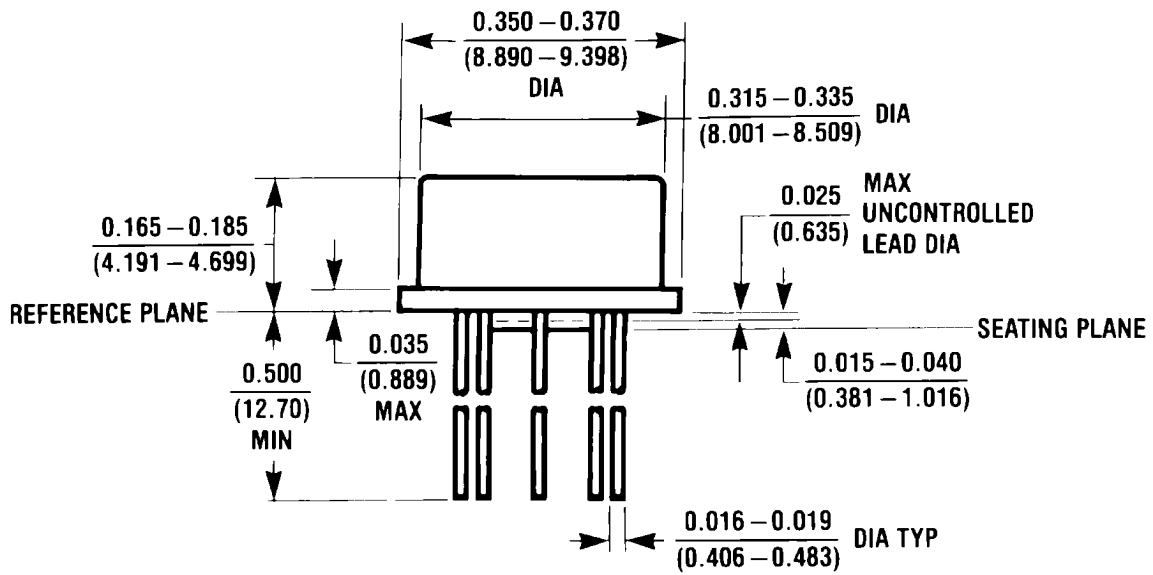

TO-99 Metal Can
Order Number LME49710HA
NS Package Number H08C

H08C (REV E)

Notes

THE CONTENTS OF THIS DOCUMENT ARE PROVIDED IN CONNECTION WITH NATIONAL SEMICONDUCTOR CORPORATION ("NATIONAL") PRODUCTS. NATIONAL MAKES NO REPRESENTATIONS OR WARRANTIES WITH RESPECT TO THE ACCURACY OR COMPLETENESS OF THE CONTENTS OF THIS PUBLICATION AND RESERVES THE RIGHT TO MAKE CHANGES TO SPECIFICATIONS AND PRODUCT DESCRIPTIONS AT ANY TIME WITHOUT NOTICE. NO LICENSE, WHETHER EXPRESS, IMPLIED, ARISING BY ESTOPPEL OR OTHERWISE, TO ANY INTELLECTUAL PROPERTY RIGHTS IS GRANTED BY THIS DOCUMENT.

TESTING AND OTHER QUALITY CONTROLS ARE USED TO THE EXTENT NATIONAL DEEMS NECESSARY TO SUPPORT NATIONAL'S PRODUCT WARRANTY. EXCEPT WHERE MANDATED BY GOVERNMENT REQUIREMENTS, TESTING OF ALL PARAMETERS OF EACH PRODUCT IS NOT NECESSARILY PERFORMED. NATIONAL ASSUMES NO LIABILITY FOR APPLICATIONS ASSISTANCE OR BUYER PRODUCT DESIGN. BUYERS ARE RESPONSIBLE FOR THEIR PRODUCTS AND APPLICATIONS USING NATIONAL COMPONENTS. PRIOR TO USING OR DISTRIBUTING ANY PRODUCTS THAT INCLUDE NATIONAL COMPONENTS, BUYERS SHOULD PROVIDE ADEQUATE DESIGN, TESTING AND OPERATING SAFEGUARDS.

EXCEPT AS PROVIDED IN NATIONAL'S TERMS AND CONDITIONS OF SALE FOR SUCH PRODUCTS, NATIONAL ASSUMES NO LIABILITY WHATSOEVER, AND NATIONAL DISCLAIMS ANY EXPRESS OR IMPLIED WARRANTY RELATING TO THE SALE AND/OR USE OF NATIONAL PRODUCTS INCLUDING LIABILITY OR WARRANTIES RELATING TO FITNESS FOR A PARTICULAR PURPOSE, MERCHANTABILITY, OR INFRINGEMENT OF ANY PATENT, COPYRIGHT OR OTHER INTELLECTUAL PROPERTY RIGHT.

LIFE SUPPORT POLICY

NATIONAL'S PRODUCTS ARE NOT AUTHORIZED FOR USE AS CRITICAL COMPONENTS IN LIFE SUPPORT DEVICES OR SYSTEMS WITHOUT THE EXPRESS PRIOR WRITTEN APPROVAL OF THE CHIEF EXECUTIVE OFFICER AND GENERAL COUNSEL OF NATIONAL SEMICONDUCTOR CORPORATION. As used herein:

Life support devices or systems are devices which (a) are intended for surgical implant into the body, or (b) support or sustain life and whose failure to perform when properly used in accordance with instructions for use provided in the labeling can be reasonably expected to result in a significant injury to the user. A critical component is any component in a life support device or system whose failure to perform can be reasonably expected to cause the failure of the life support device or system or to affect its safety or effectiveness.

National Semiconductor and the National Semiconductor logo are registered trademarks of National Semiconductor Corporation. All other brand or product names may be trademarks or registered trademarks of their respective holders.

Copyright© 2007 National Semiconductor Corporation

For the most current product information visit us at www.national.com



National Semiconductor Americas Customer Support Center
 Email: new.feedback@nsc.com
 Tel: 1-800-272-9959

National Semiconductor Europe Customer Support Center
 Fax: +49 (0) 180-530-85-86
 Email: europe.support@nsc.com
 Deutsch Tel: +49 (0) 69 9508 6208
 English Tel: +49 (0) 870 24 0 2171
 Français Tel: +33 (0) 1 41 91 8790

National Semiconductor Asia Pacific Customer Support Center
 Email: ap.support@nsc.com

National Semiconductor Japan Customer Support Center
 Fax: 81-3-5639-7507
 Email: jpn.feedback@nsc.com
 Tel: 81-3-5639-7560