



## STX13003

# HIGH VOLTAGE FAST-SWITCHING NPN POWER TRANSISTOR

- ST13003 SILICON IN TO-92 PACKAGE
- MEDIUM VOLTAGE CAPABILITY
- LOW SPREAD OF DYNAMIC PARAMETERS
- MINIMUM LOT-TO-LOT SPREAD FOR RELIABLE OPERATION
- VERY HIGH SWITCHING SPEED

### APPLICATIONS:

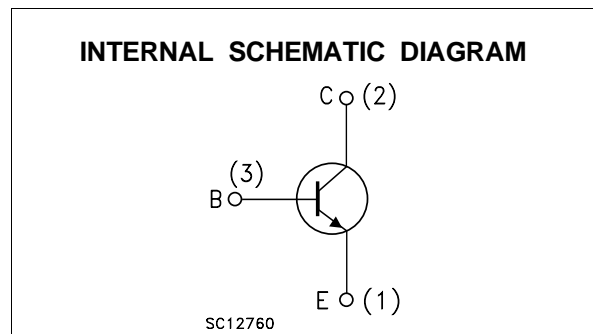
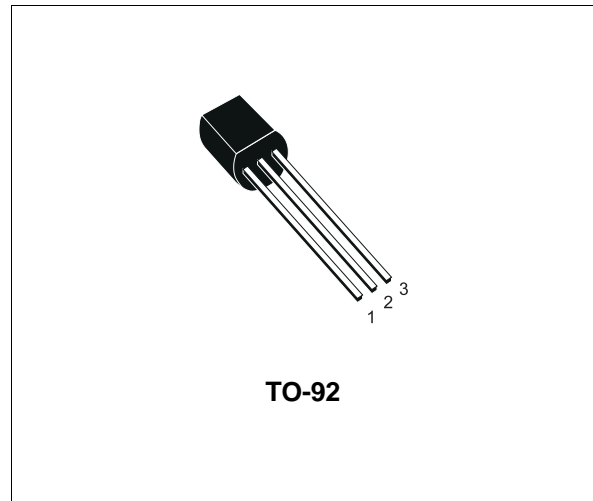
- ELECTRONIC BALLASTS FOR FLUORESCENT LIGHTING

### DESCRIPTION

The device is manufactured using high voltage Multi Epitaxial Planar technology for high switching speeds and medium voltage capability.

It uses a Cellular Emitter structure with planar edge termination to enhance switching speeds while maintaining the wide RBSOA.

The STX13003 is designed for use in compact fluorescent lamp application.



### ABSOLUTE MAXIMUM RATINGS

Symbol	Parameter	Value	Unit
$V_{CES}$	Collector-Emitter Voltage ( $V_{BE} = 0$ )	700	V
$V_{CEO}$	Collector-Emitter Voltage ( $I_B = 0$ )	400	V
$V_{EBO}$	Emitter-Base Voltage ( $I_C = 0, I_B = 0.5 \text{ A}, t_p < 10 \mu\text{s}, T_j < 150^\circ\text{C}$ )	$BV_{EBO}$	V
$I_C$	Collector Current	1	A
$I_{CM}$	Collector Peak Current ( $t_p < 5 \text{ ms}$ )	3	A
$I_B$	Base Current	0.5	A
$I_{BM}$	Base Peak Current ( $t_p < 5 \text{ ms}$ )	1.5	A
$P_{tot}$	Total Dissipation at $T_C = 25^\circ\text{C}$	1.5	W
$T_{stg}$	Storage Temperature	-65 to 150	$^\circ\text{C}$
$T_j$	Max. Operating Junction Temperature	150	$^\circ\text{C}$

## STX13003

### THERMAL DATA

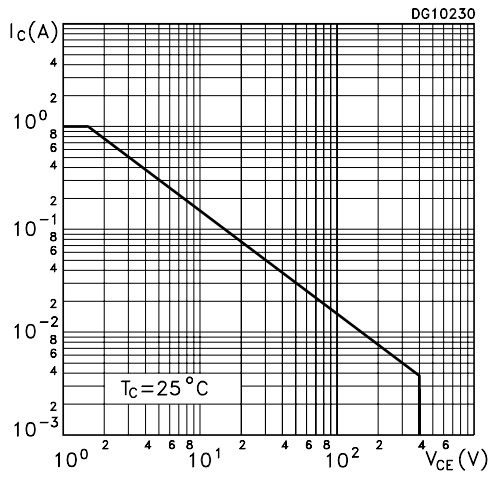
R <sub>thj-case</sub>	Thermal Resistance Junction-case	Max	83.3	°C/W
-----------------------	----------------------------------	-----	------	------

### ELECTRICAL CHARACTERISTICS (T<sub>case</sub> = 25 °C unless otherwise specified)

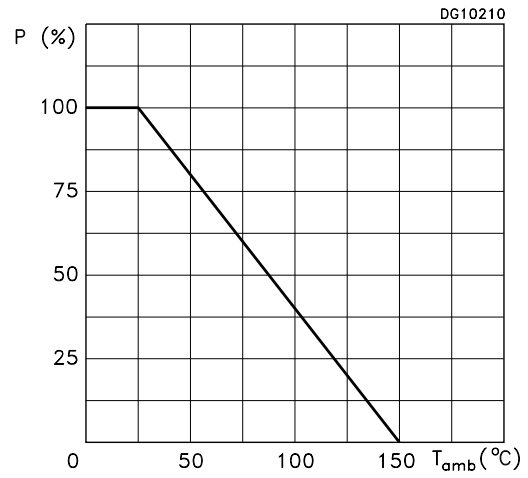
Symbol	Parameter	Test Conditions	Min.	Typ.	Max.	Unit
I <sub>CEV</sub>	Collector Cut-off Current (V <sub>BE</sub> = -1.5V)	V <sub>CE</sub> = 700V V <sub>CE</sub> = 700V T <sub>j</sub> = 125°C			1 5	mA mA
BV <sub>EBO</sub>	Emitter-Base Breakdown Voltage (I <sub>C</sub> = 0)	I <sub>E</sub> = 10 mA	9		18	V
V <sub>CEO(sus)*</sub>	Collector-Emitter Sustaining Voltage (I <sub>B</sub> = 0)	I <sub>C</sub> = 10 mA L = 25 mH	400			V
V <sub>CE(sat)*</sub>	Collector-Emitter Saturation Voltage	I <sub>C</sub> = 0.5 A I <sub>C</sub> = 1 A I <sub>C</sub> = 1.5 A			0.5 1 3	V V V
V <sub>BE(sat)*</sub>	Base-Emitter Saturation Voltage	I <sub>C</sub> = 0.5 A I <sub>C</sub> = 1 A			1 1.2	V V
h <sub>FE*</sub>	DC Current Gain	I <sub>C</sub> = 0.5 A I <sub>C</sub> = 1 A			8 5	
t <sub>r</sub> t <sub>s</sub> t <sub>f</sub>	RESISTIVE LOAD Rise Time Storage Time Fall Time	I <sub>C</sub> = 1 A I <sub>B1</sub> = 0.2 A T <sub>p</sub> = 25 μs			1 4 0.7	μs μs μs
t <sub>s</sub>	INDUCTIVE LOAD Storage Time	I <sub>C</sub> = 1 A V <sub>BE</sub> = -5 V V <sub>clamp</sub> = 300 V		0.8		μs

\* Pulsed: Pulse duration = 300μs, duty cycle = 1.5 %.

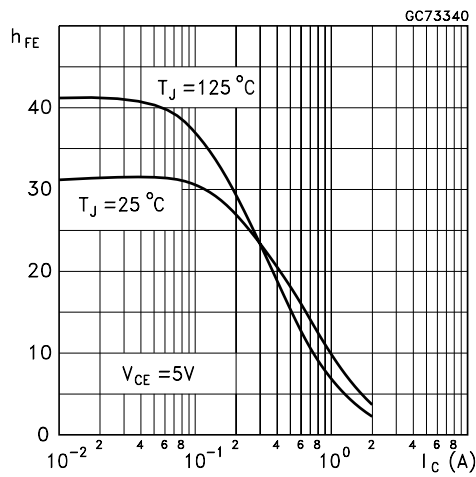
Safe Operating Area



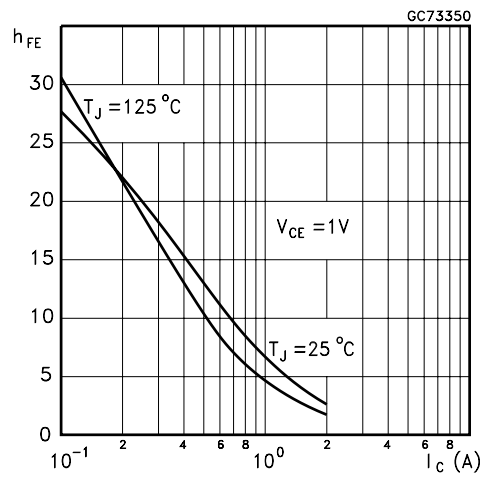
Derating Curve



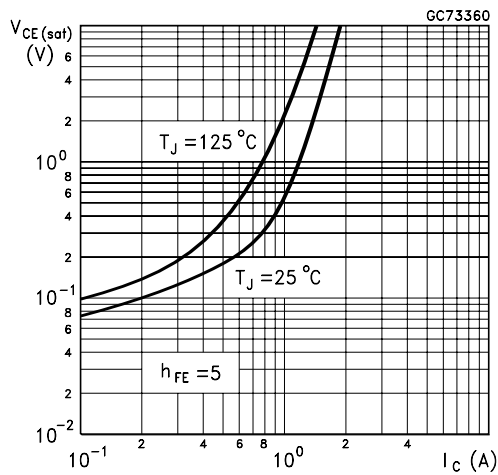
DC Current Gain



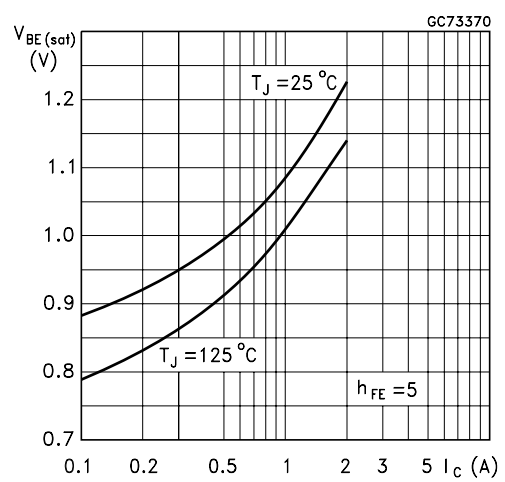
DC Current Gain



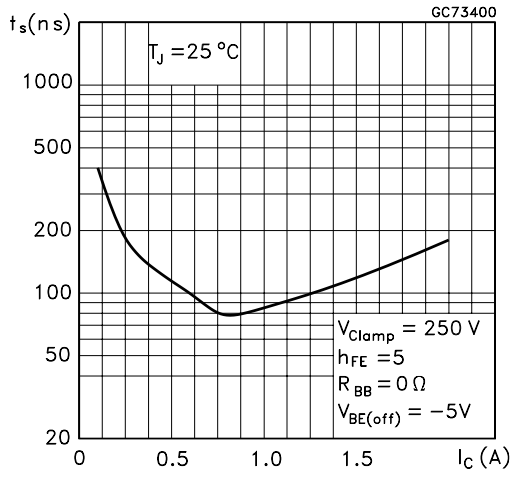
Collector Emitter Saturation Voltage



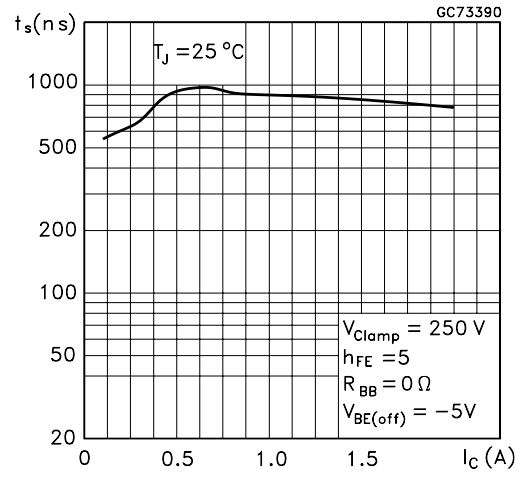
Base Emitter Saturation Voltage



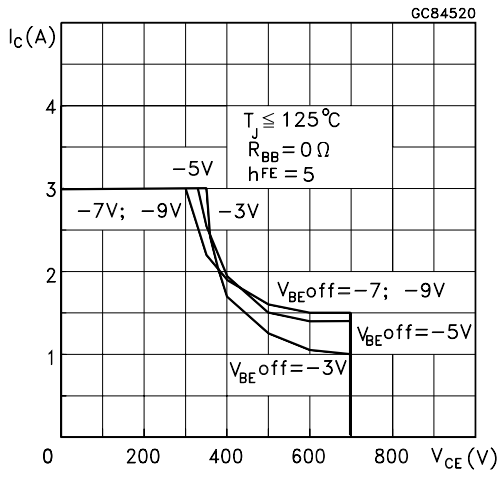
Inductive Fall Time



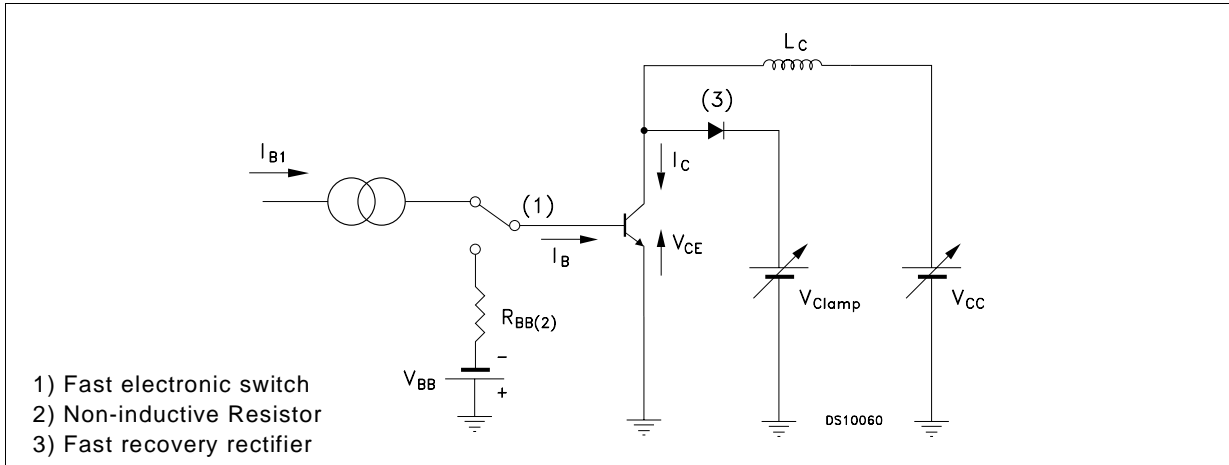
Inductive Storage Time



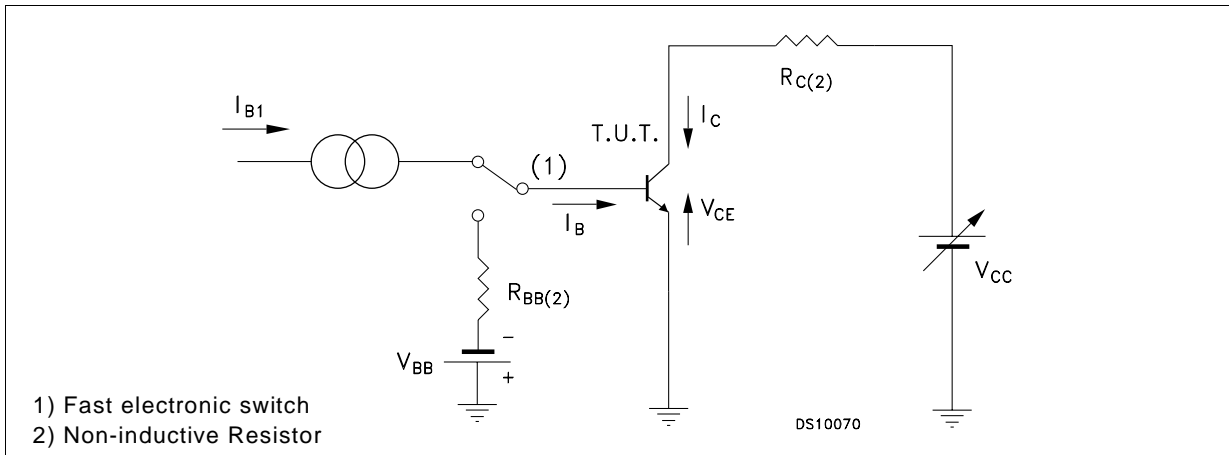
Reverse Biased SOA



**Figure 1: Inductive Load Switching Test Circuits.**

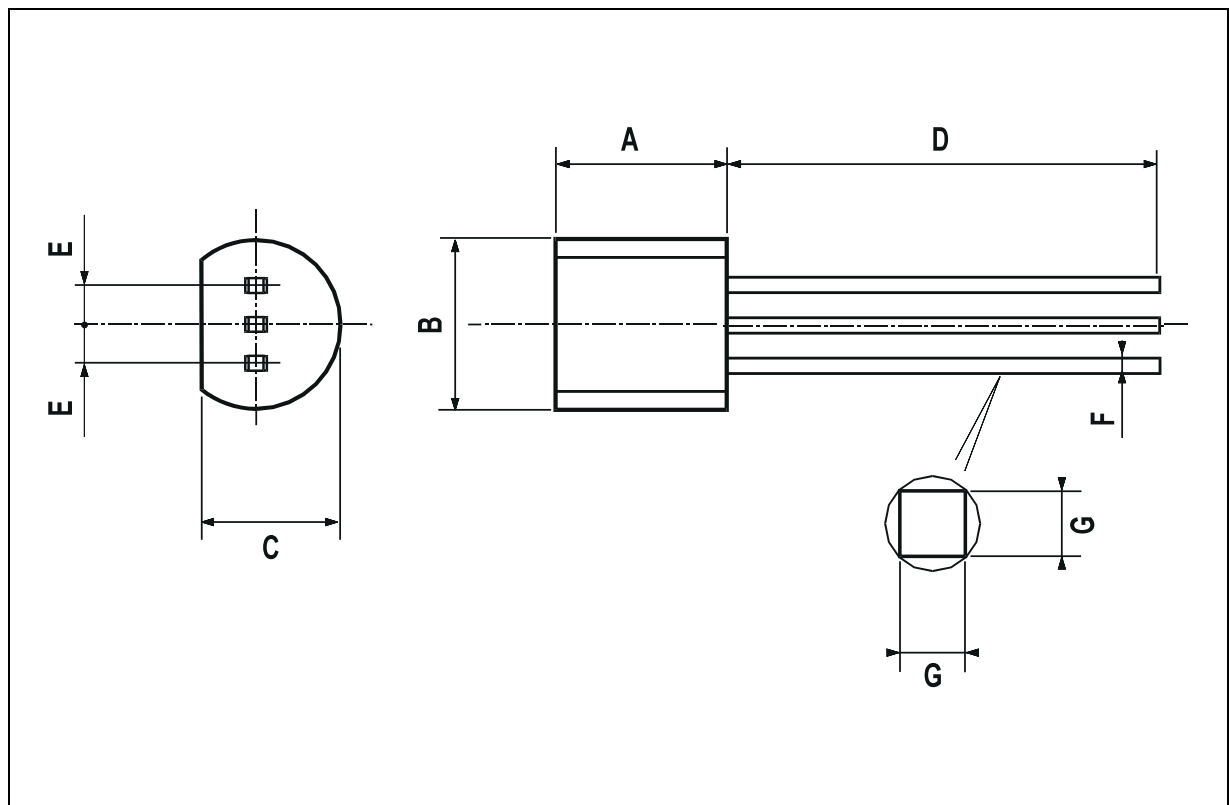


**Figure 2: Resistive Load Switching Test Circuits.**



**TO-92 MECHANICAL DATA**

DIM.	mm			inch		
	MIN.	TYP.	MAX.	MIN.	TYP.	MAX.
A	4.58		5.33	0.180		0.210
B	4.45		5.2	0.175		0.204
C	3.2		4.2	0.126		0.165
D	12.7			0.500		
E		1.27			0.050	
F	0.4		0.51	0.016		0.020
G	0.35			0.14		



Information furnished is believed to be accurate and reliable. However, STMicroelectronics assumes no responsibility for the consequences of use of such information nor for any infringement of patents or other rights of third parties which may result from its use. No license is granted by implication or otherwise under any patent or patent rights of STMicroelectronics. Specification mentioned in this publication are subject to change without notice. This publication supersedes and replaces all information previously supplied. STMicroelectronics products are not authorized for use as critical components in life support devices or systems without express written approval of STMicroelectronics.

The ST logo is a trademark of STMicroelectronics

© 2001 STMicroelectronics – Printed in Italy – All Rights Reserved

STMicroelectronics GROUP OF COMPANIES

Australia - Brazil - China - Finland - France - Germany - Hong Kong - India - Italy - Japan - Malaysia - Malta - Morocco - Singapore - Spain - Sweden - Switzerland - United Kingdom - U.S.A.

<http://www.st.com>