

## True +3.0V to +5.5V RS-232 Transceivers

- Meets true EIA/TIA-232-F Standards from a +3.0V to +5.5V power supply
- Minimum 120Kbps Data Rate Under Full Load
- 1 $\mu$ A Low-Power Shutdown with Receivers Active (**SP3222E**)
- Interoperable with RS-232 down to +2.7V power source
- Enhanced ESD Specifications:
  - ±15kV Human Body Model
  - ±15kV IEC1000-4-2 Air Discharge
  - ±8kV IEC1000-4-2 Contact Discharge



### DESCRIPTION

The **SP3222E/3232E** series is an RS-232 transceiver solution intended for portable or hand-held applications such as notebook or palmtop computers. The **SP3222E/3232E** series has a high-efficiency, charge-pump power supply that requires only 0.1 $\mu$ F capacitors in 3.3V operation. This charge pump allows the **SP3222E/3232E** series to deliver true RS-232 performance from a single power supply ranging from +3.3V to +5.0V. The **SP3222E/3232E** are 2-driver/2-receiver devices. This series is ideal for portable or hand-held applications such as notebook or palmtop computers. The ESD tolerance of the **SP3222E/3232E** devices are over  $\pm$ 15kV for both Human Body Model and IEC1000-4-2 Air discharge test methods. The **SP3222E** device has a low-power shutdown mode where the devices' driver outputs and charge pumps are disabled. During shutdown, the supply current falls to less than 1 $\mu$ A.

### SELECTION TABLE

MODEL	Power Supplies	RS-232 Drivers	RS-232 Receivers	External Components	Shutdown	TTL 3-State	No. of Pins
<b>SP3222</b>	+3.0V to +5.5V	2	2	4	Yes	Yes	18, 20
<b>SP3232</b>	+3.0V to +5.5V	2	2	4	No	No	16

## ABSOLUTE MAXIMUM RATINGS

These are stress ratings only and functional operation of the device at these ratings or any other above those indicated in the operation sections of the specifications below is not implied. Exposure to absolute maximum rating conditions for extended periods of time may affect reliability and cause permanent damage to the device.

$V_{CC}$ .....-0.3V to +6.0V  
 $V+$  (NOTE 1).....-0.3V to +7.0V  
 $V-$  (NOTE 1).....+0.3V to -7.0V  
 $V+ + |V-|$  (NOTE 1).....+13V

$I_{CC}$  (DC  $V_{CC}$  or GND current).....±100mA

## Input Voltages

$TxIN, \overline{EN}$  ..... -0.3V to +6.0V  
 $RxIN$  ..... ±15V

## Output Voltages

$TxOUT$  ..... ±15V  
 $RxOUT$  ..... -0.3V to ( $V_{CC} + 0.3V$ )

## Short-Circuit Duration

$TxOUT$  ..... Continuous

Storage Temperature ..... -65°C to +150°C

## Power Dissipation Per Package

20-pin SSOP (derate 9.25mW/°C above +70°C) ..... 750mW  
 18-pin PDIP (derate 15.2mW/°C above +70°C) .... 1220mW  
 18-pin SOIC (derate 15.7mW/°C above +70°C) ... 1260mW  
 20-pin TSSOP (derate 11.1mW/°C above +70°C) .. 890mW  
 16-pin SSOP (derate 9.69mW/°C above +70°C) ..... 775mW  
 16-pin PDIP (derate 14.3mW/°C above +70°C) .... 1150mW  
 16-pin Wide SOIC (derate 11.2mW/°C above +70°C) 900mW  
 16-pin TSSOP (derate 10.5mW/°C above +70°C) .. 850mW  
 16-pin nSOIC (derate 13.57mW/°C above +70°C) .. 1086mW

**NOTE 1:**  $V+$  and  $V-$  can have maximum magnitudes of 7V, but their absolute difference cannot exceed 13V.

## SPECIFICATIONS

Unless otherwise noted, the following specifications apply for  $V_{CC} = +3.0V$  to +5.0V with  $T_{AMB} = T_{MIN}$  to  $T_{MAX}$

PARAMETER	MIN.	TYP.	MAX.	UNITS	CONDITIONS
DC CHARACTERISTICS					
Supply Current		0.3	1.0	mA	no load, $T_{AMB} = +25^{\circ}C$ , $V_{CC} = 3.3V$
Shutdown Supply Current		1.0	10	μA	$\overline{SHDN} = GND$ , $T_{AMB} = +25^{\circ}C$ , $V_{CC} = +3.3V$
LOGIC INPUTS AND RECEIVER OUTPUTS					
Input Logic Threshold LOW			0.8	V	$TxIN, \overline{EN}, \overline{SHDN}$ , Note 2
Input Logic Threshold HIGH	2.0 2.4			V	$V_{CC} = 3.3V$ , Note 2 $V_{CC} = 5.0V$ , Note 2
Input Leakage Current		±0.01	±1.0	μA	$TxIN, \overline{EN}, \overline{SHDN}$ , $T_{AMB} = +25^{\circ}C$
Output Leakage Current		±0.05	±10	μA	receivers disabled
Output Voltage LOW			0.4	V	$I_{OUT} = 1.6mA$
Output Voltage HIGH	$V_{CC}-0.6$	$V_{CC}-0.1$		V	$I_{OUT} = -1.0mA$
DRIVER OUTPUTS					
Output Voltage Swing	±5.0	±5.4		V	3kΩ load to ground at all driver outputs, $T_{AMB} = +25^{\circ}C$
Output Resistance	300			Ω	$V_{CC} = V+ = V- = 0V$ , $T_{OUT} = \pm 2V$
Output Short-Circuit Current		±35 ±70	±60 ±100	mA mA	$V_{OUT} = 0V$ $V_{OUT} = \pm 15V$
Output Leakage Current			±25	μA	$V_{OUT} = \pm 12V, V_{CC} = 0V$ to 5.5V, drivers disabled

## SPECIFICATIONS (continued)

Unless otherwise noted, the following specifications apply for  $V_{CC} = +3.0V$  to  $+5.0V$  with  $T_{AMB} = T_{MIN}$  to  $T_{MAX}$ .  
 Typical Values apply at  $V_{CC} = +3.3V$  or  $+5.0V$  and  $T_{AMB} = 25^{\circ}C$ .

PARAMETER	MIN.	TYP.	MAX.	UNITS	CONDITIONS
RECEIVER INPUTS					
Input Voltage Range	-15		+15	V	
Input Threshold LOW	0.6 0.8	1.2 1.5		V	$V_{CC}=3.3V$ $V_{CC}=5.0V$
Input Threshold HIGH		1.5 1.8	2.4 2.4	V	$V_{CC}=3.3V$ $V_{CC}=5.0V$
Input Hysteresis		0.3		V	
Input Resistance	3	5	7	k $\Omega$	
TIMING CHARACTERISTICS					
Maximum Data Rate	120	235		kbps	$R_L=3k\Omega$ , $C_L=1000pF$ , one driver switching
Driver Propagation Delay		1.0 1.0		$\mu s$ $\mu s$	$t_{PHL}$ , $R_L = 3K\Omega$ , $C_L = 1000pF$ $t_{PLH}$ , $R_L = 3K\Omega$ , $C_L = 1000pF$
Receiver Propagation Delay		0.3 0.3		$\mu s$	$t_{PHL}$ , RxIN to RxOUT, $C_L=150pF$ $t_{PLH}$ , RxIN to RxOUT, $C_L=150pF$
Receiver Output Enable Time		200		ns	
Receiver Output Disable Time		200		ns	
Driver Skew		100	500	ns	$ t_{PHL} - t_{PLH} $ , $T_{AMB} = 25^{\circ}C$
Receiver Skew		200	1000	ns	$ t_{PHL} - t_{PLH} $
Transition-Region Slew Rate			30	V/ $\mu s$	$V_{CC} = 3.3V$ , $R_L = 3K\Omega$ , $T_{AMB} = 25^{\circ}C$ , measurements taken from $-3.0V$ to $+3.0V$ or $+3.0V$ to $-3.0V$

**NOTE 2:** Driver input hysteresis is typically 250mV.

## TYPICAL PERFORMANCE CHARACTERISTICS

Unless otherwise noted, the following performance characteristics apply for  $V_{CC} = +3.3V$ , 120kbps data rates, all drivers loaded with  $3k\Omega$ ,  $0.1\mu F$  charge pump capacitors, and  $T_{AMB} = +25^{\circ}C$ .

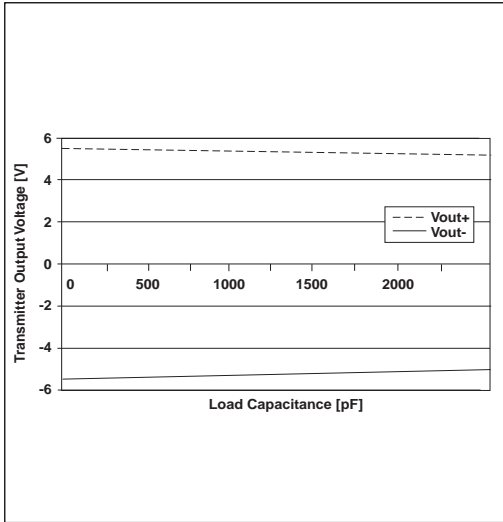


Figure 1. Transmitter Output Voltage VS. Load Capacitance for the SP3222 and the SP3232

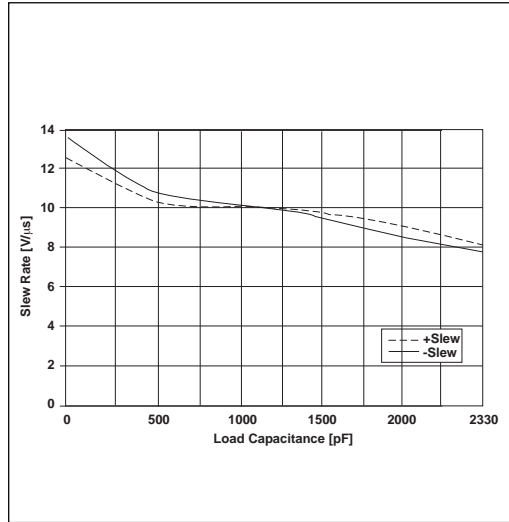


Figure 2. Slew Rate VS. Load Capacitance for the SP3222 and the SP3232

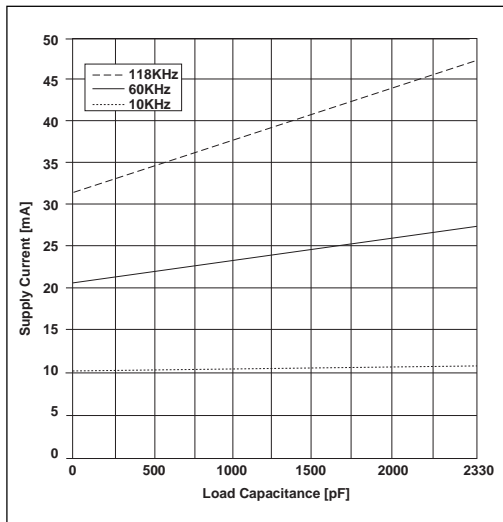


Figure 3. Supply Current VS. Load Capacitance when Transmitting Data for the SP3222 and the SP3232

NAME	FUNCTION	PIN NUMBER		
		SP3222E		SP3232E
		DIP/SO	SSOP/ TSSOP	
$\overline{\text{EN}}$	Receiver Enable. Apply logic LOW for normal operation. Apply logic HIGH to disable the receiver outputs (high-Z state).	1	1	-
C1+	Positive terminal of the voltage doubler charge-pump capacitor.	2	2	1
V+	+5.5V generated by the charge pump.	3	3	2
C1-	Negative terminal of the voltage doubler charge-pump capacitor.	4	4	3
C2+	Positive terminal of the inverting charge-pump capacitor.	5	5	4
C2-	Negative terminal of the inverting charge-pump capacitor.	6	6	5
V-	-5.5V generated by the charge pump.	7	7	6
T1OUT	RS-232 driver output.	15	17	14
T2OUT	RS-232 driver output.	8	8	7
R1IN	RS-232 receiver input.	14	16	13
R2IN	RS-232 receiver input.	9	9	8
R1OUT	TTL/CMOS receiver output.	13	15	12
R2OUT	TTL/CMOS receiver output.	10	10	9
T1IN	TTL/CMOS driver input.	12	13	11
T2IN	TTL/CMOS driver input.	11	12	10
GND	Ground.	16	18	15
V <sub>cc</sub>	+3.0V to +5.5V supply voltage	17	19	16
$\overline{\text{SHDN}}$	Shutdown Control Input. Drive HIGH for normal device operation. Drive LOW to shutdown the drivers (high-Z output) and the on-board power supply.	18	20	-
N.C.	No Connect.	-	11, 14	-

*Table 1. Device Pin Description*

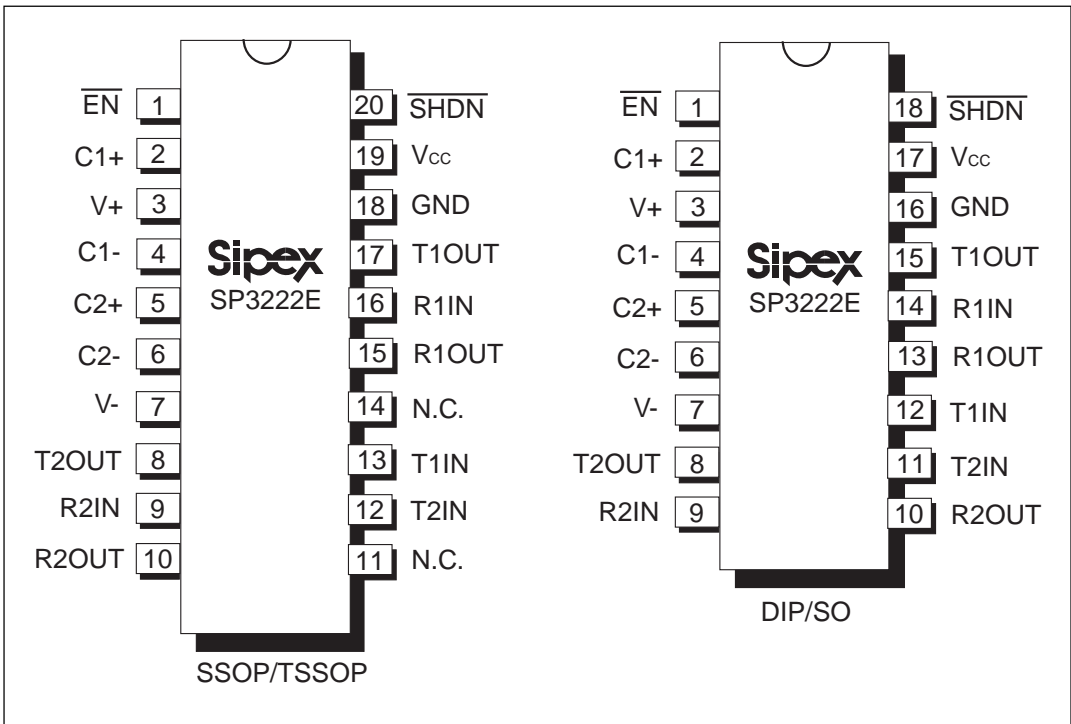


Figure 4. Pinout Configurations for the SP3222E

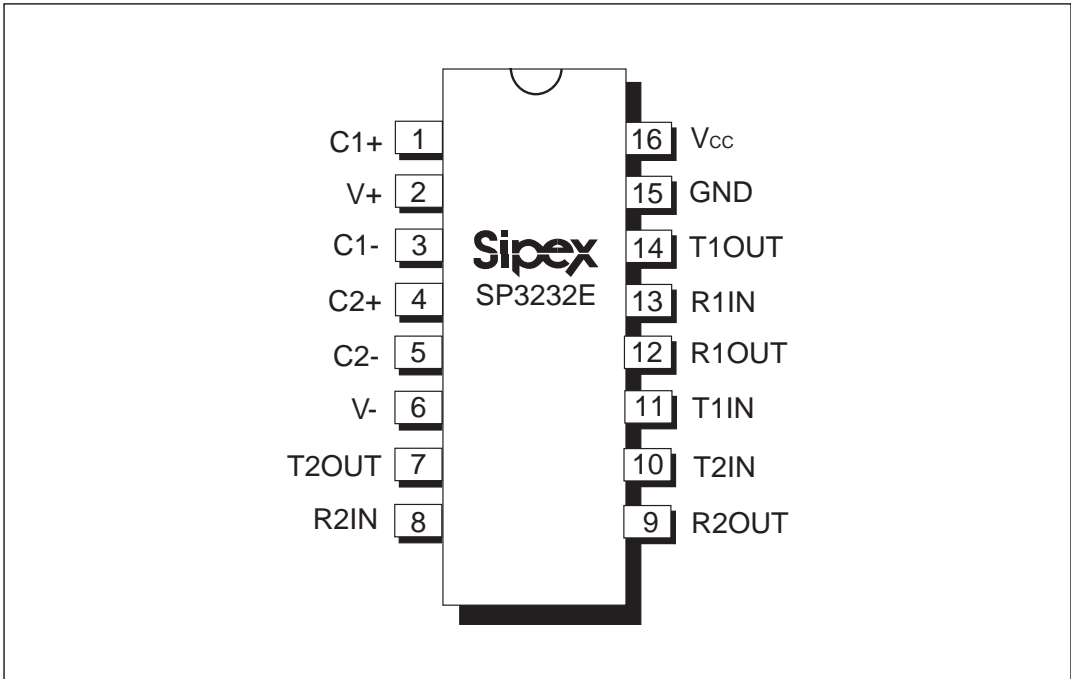


Figure 5. Pinout Configuration for the SP3232E

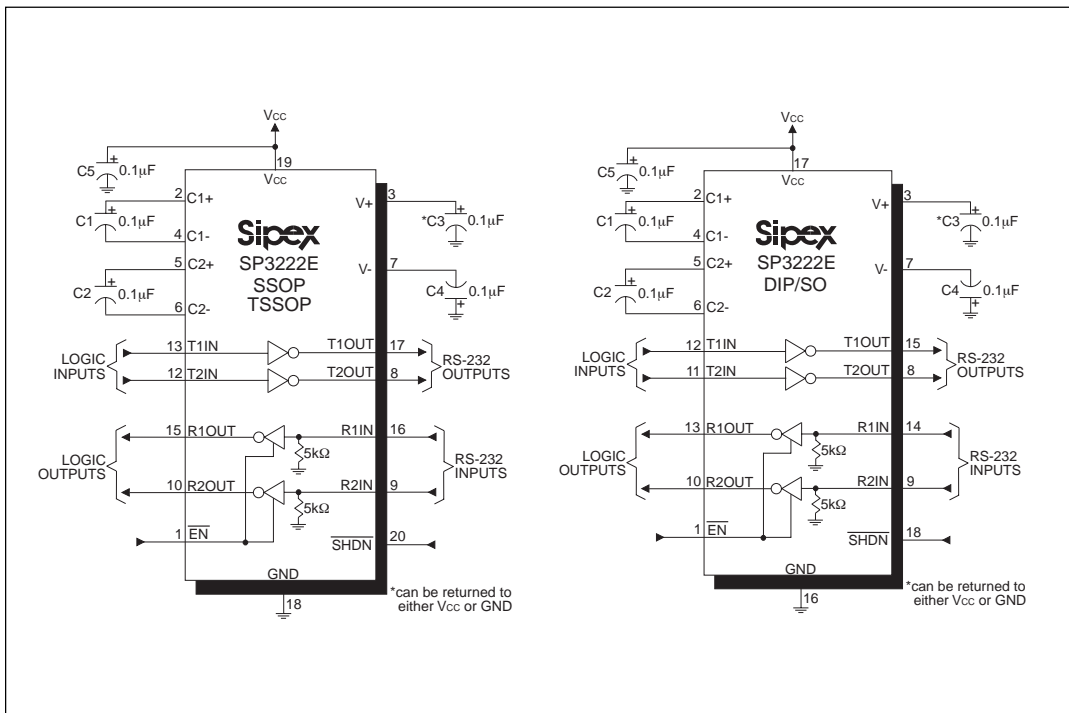


Figure 6. SP3222E Typical Operating Circuits

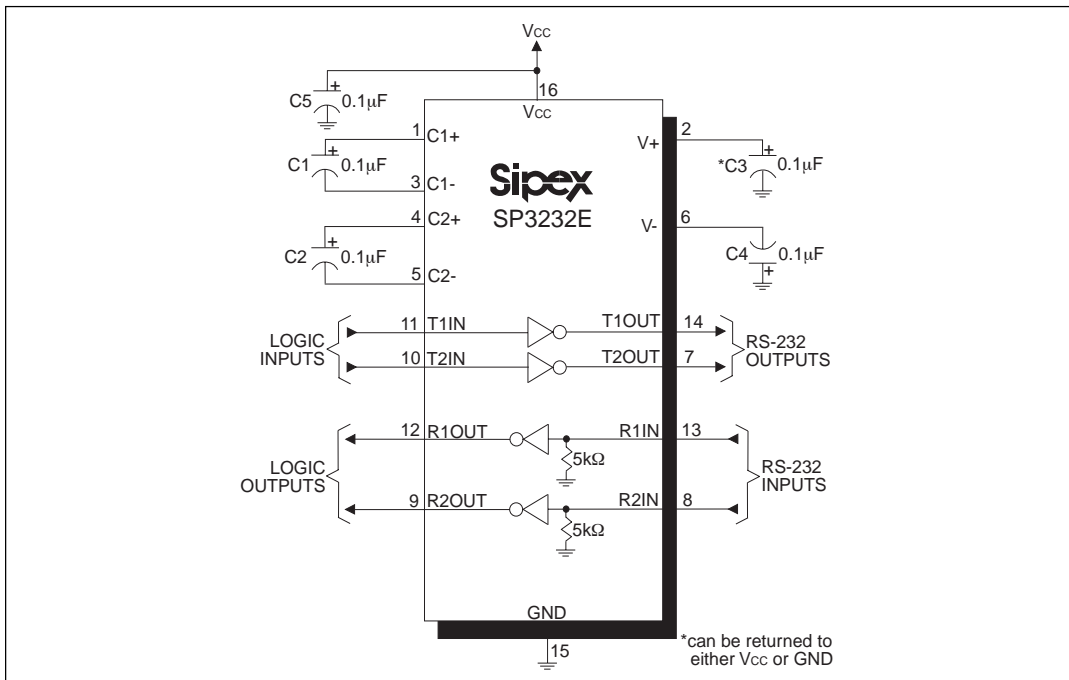


Figure 7. SP3232E Typical Operating Circuit

## DESCRIPTION

The **SP3222E/3232E** transceivers meet the EIA/TIA-232 and V.28/V.24 communication protocols and can be implemented in battery-powered, portable, or hand-held applications such as notebook or palmtop computers. The **SP3222E/3232E** devices all feature **Sipex's** proprietary on-board charge pump circuitry that generates  $2 \times V_{CC}$  for RS-232 voltage levels from a single +3.0V to +5.5V power supply. This series is ideal for +3.3V-only systems, mixed +3.3V to +5.5V systems, or +5.0V-only systems that require true RS-232 performance. The **SP3222E/3232E** series have drivers that operate at a typical data rate of 235Kbps fully loaded.

The **SP3222E** and **SP3232E** are 2-driver/2-receiver devices ideal for portable or hand-held applications. The **SP3222E** features a  $1\mu\text{A}$  shutdown mode that reduces power consumption and extends battery life in portable systems. Its receivers remain active in shutdown mode, allowing external devices such as modems to be monitored using only  $1\mu\text{A}$  supply current.

## THEORY OF OPERATION

The **SP3222E/3232E** series are made up of three basic circuit blocks: 1. Drivers, 2. Receivers, and 3. the Sipex proprietary charge pump.

### Drivers

The drivers are inverting level transmitters that convert TTL or CMOS logic levels to  $\pm 5.0\text{V}$  EIA/TIA-232 levels inverted relative to the input logic levels. Typically, the RS-232 output voltage swing is  $\pm 5.5\text{V}$  with no load and at least  $\pm 5\text{V}$  minimum fully loaded. The driver outputs are protected against infinite short-circuits to ground without degradation in reliability. Driver outputs will meet EIA/TIA-562 levels of  $\pm 3.7\text{V}$  with supply voltages as low as  $2.7\text{V}$ .

The drivers typically can operate at a data rate of 235Kbps. The drivers can guarantee a data rate of 120Kbps fully loaded with  $3\text{K}\Omega$  in parallel with  $1000\text{pF}$ , ensuring compatibility with PC-to-PC communication software.

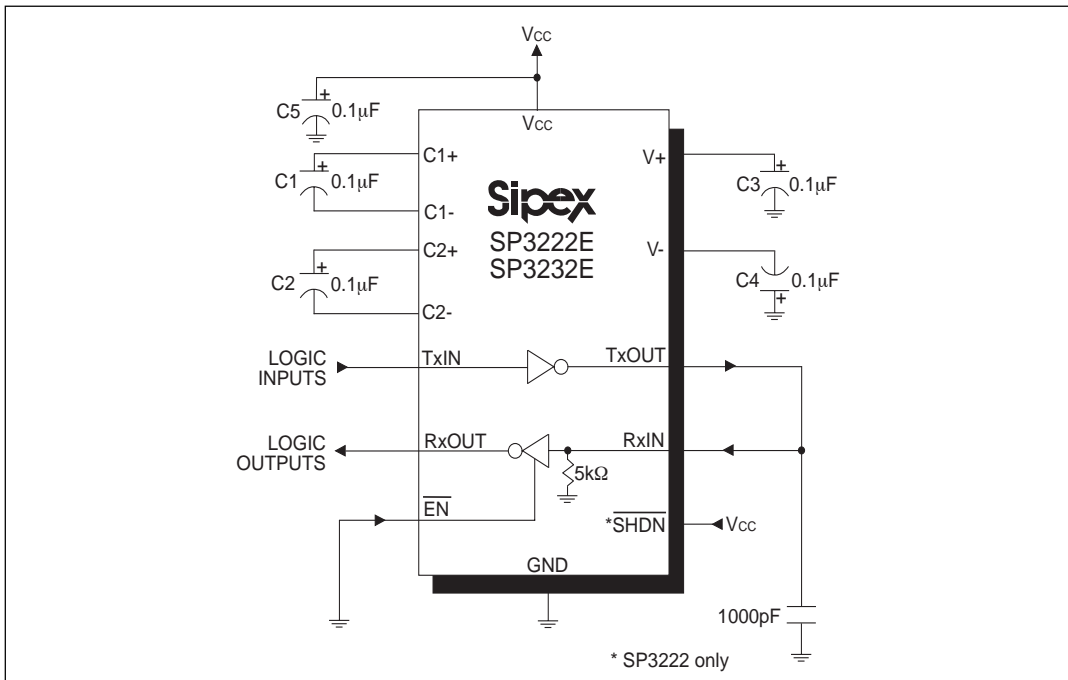
The slew rate of the driver output is internally limited to a maximum of  $30\text{V}/\mu\text{s}$  in order to meet the EIA standards (EIA RS-232D 2.1.7, Paragraph 5). The transition of the loaded output from HIGH to LOW also meets the monotonicity requirements of the standard.

The **SP3222E/3232E** drivers can maintain high data rates up to 235Kbps fully loaded. *Figure 8* shows a loopback test circuit used to test the RS-232 drivers. *Figure 9* shows the test results of the loopback circuit with all drivers active at 120Kbps with RS-232 loads in parallel with  $1000\text{pF}$  capacitors. *Figure 10* shows the test results where one driver was active at 235Kbps and all drivers loaded with an RS-232 receiver in parallel with a  $1000\text{pF}$  capacitor. A solid RS-232 data transmission rate of 120Kbps provides compatibility with many designs in personal computer peripherals and LAN applications.

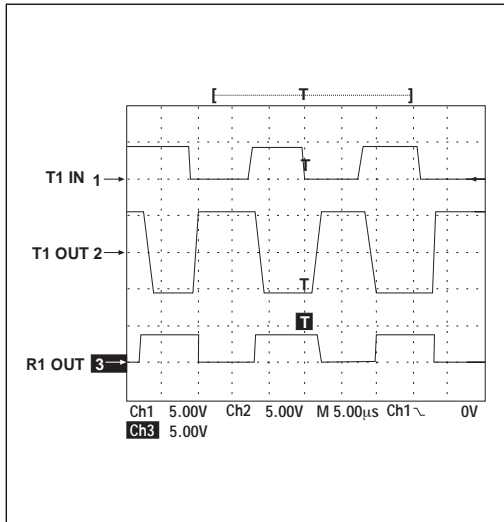
The **SP3222E** driver's output stages are turned off (tri-state) when the device is in shutdown mode. When the power is off, the **SP3222E** device permits the outputs to be driven up to  $\pm 12\text{V}$ . The driver's inputs do not have pull-up resistors. Designers should connect unused inputs to  $V_{CC}$  or GND.

In the shutdown mode, the supply current falls to less than  $1\mu\text{A}$ , where  $\overline{\text{SHDN}} = \text{LOW}$ . When the **SP3222E** device is shut down, the device's driver outputs are disabled (tri-stated) and the charge pumps are turned off with  $V+$  pulled down to  $V_{CC}$  and  $V-$  pulled to GND. The time required to exit shutdown is typically  $100\mu\text{s}$ . Connect  $\overline{\text{SHDN}}$  to  $V_{CC}$  if the shutdown mode is not used.  $\overline{\text{SHDN}}$  has no effect on RxOUT or RxOUTB. As they become active, the two driver outputs go to opposite RS-232 levels where one driver input is HIGH and the other LOW. Note that the drivers are enabled only when the magnitude of  $V-$  exceeds approximately  $3\text{V}$ .

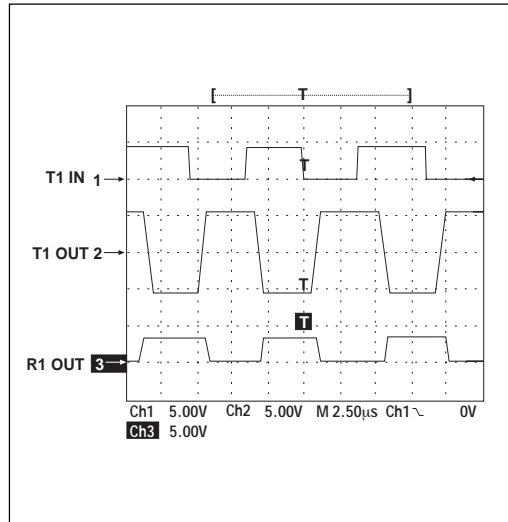




**Figure 8. SP3222E/3232E Driver Loopback Test Circuit**



**Figure 9. Driver Loopback Test Results at 120kbps**



**Figure 10. Driver Loopback Test Results at 235kbps**

## Receivers

The receivers convert EIA/TIA-232 levels to TTL or CMOS logic output levels. All receivers have an inverting tri-state output. These receiver outputs ( $\overline{\text{RxOUT}}$ ) are tri-stated when the enable control  $\overline{\text{EN}} = \text{HIGH}$ . In the shutdown mode, the receivers can be active or inactive.  $\overline{\text{EN}}$  has no effect on TxOUT. The truth table logic of the **SP3222E/3232E** driver and receiver outputs can be found in *Table 2*.

Since receiver input is usually from a transmission line where long cable lengths and system interference can degrade the signal, the inputs have a typical hysteresis margin of 300mV. This ensures that the receiver is virtually immune to noisy transmission lines. Should an input be left unconnected, a 5k $\Omega$  pull-down resistor to ground will commit the output of the receiver to a HIGH state.

## Charge Pump

The charge pump is a **Sipex**-patented design (5,306,954) and uses a unique approach compared to older less-efficient designs. The charge pump still requires four external capacitors, but uses a four-phase voltage shifting technique to attain symmetrical 5.5V power supplies. The internal power supply consists of a regulated dual charge pump that provides output voltages 5.5V regardless of the input voltage ( $V_{\text{CC}}$ ) over the +3.0V to +5.5V range.

$\overline{\text{SHDN}}$	$\overline{\text{EN}}$	TxOUT	RxOUT
0	0	Tri-state	Active
0	1	Tri-state	Tri-state
1	0	Active	Active
1	1	Active	Tri-state

*Table 2. Truth Table Logic for Shutdown and Enable Control*

In most circumstances, decoupling the power supply can be achieved adequately using a 0.1 $\mu\text{F}$  bypass capacitor at C5 (refer to *Figures 6* and *7*). In applications that are sensitive to power-supply noise, decouple  $V_{\text{CC}}$  to ground with a capacitor of the same value as charge-pump capacitor C1. Physically connect bypass capacitors as close to the IC as possible.

The charge pumps operate in a discontinuous mode using an internal oscillator. If the output voltages are less than a magnitude of 5.5V, the charge pumps are enabled. If the output voltage exceed a magnitude of 5.5V, the charge pumps are disabled. This oscillator controls the four phases of the voltage shifting. A description of each phase follows.

### Phase 1

—  $V_{\text{SS}}$  charge storage — During this phase of the clock cycle, the positive side of capacitors  $C_1$  and  $C_2$  are initially charged to  $V_{\text{CC}}$ .  $C_1^+$  is then switched to GND and the charge in  $C_1^-$  is transferred to  $C_2^-$ . Since  $C_2^+$  is connected to  $V_{\text{CC}}$ , the voltage potential across capacitor  $C_2$  is now 2 times  $V_{\text{CC}}$ .

### Phase 2

—  $V_{\text{SS}}$  transfer — Phase two of the clock connects the negative terminal of  $C_2$  to the  $V_{\text{SS}}$  storage capacitor and the positive terminal of  $C_2$  to GND. This transfers a negative generated voltage to  $C_3$ . This generated voltage is regulated to a minimum voltage of -5.5V. Simultaneous with the transfer of the voltage to  $C_3$ , the positive side of capacitor  $C_1$  is switched to  $V_{\text{CC}}$  and the negative side is connected to GND.

### Phase 3

—  $V_{\text{DD}}$  charge storage — The third phase of the clock is identical to the first phase — the charge transferred in  $C_1$  produces  $-V_{\text{CC}}$  in the negative terminal of  $C_1$ , which is applied to the negative side of capacitor  $C_2$ . Since  $C_2^+$  is at  $V_{\text{CC}}$ , the voltage potential across  $C_2$  is 2 times  $V_{\text{CC}}$ .

## Phase 4

—  $V_{DD}$  transfer — The fourth phase of the clock connects the negative terminal of  $C_2$  to GND, and transfers this positive generated voltage across  $C_2$  to  $C_4$ , the  $V_{DD}$  storage capacitor. This voltage is regulated to +5.5V. At this voltage, the internal oscillator is disabled. Simultaneous with the transfer of the voltage to  $C_4$ , the positive side of capacitor  $C_1$  is switched to  $V_{CC}$  and the negative side is connected to GND, allowing the charge pump cycle to begin again. The charge pump cycle will continue as long as the operational conditions for the internal oscillator are present.

Since both  $V^+$  and  $V^-$  are separately generated from  $V_{CC}$ ; in a no-load condition  $V^+$  and  $V^-$  will be symmetrical. Older charge pump approaches that generate  $V^-$  from  $V^+$  will show a decrease in the magnitude of  $V^-$  compared to  $V^+$  due to the inherent inefficiencies in the design.

The clock rate for the charge pump typically operates at 250kHz. The external capacitors can be as low as 0.1 $\mu$ F with a 16V breakdown voltage rating.

## ESD Tolerance

The **SP3222E/3232E** series incorporates ruggedized ESD cells on all driver output and receiver input pins. The ESD structure is improved over our previous family for more rugged applications and environments sensitive to electro-static discharges and associated transients. The improved ESD tolerance is at least  $\pm 15$ kV without damage nor latch-up.

There are different methods of ESD testing applied:

- a) MIL-STD-883, Method 3015.7
- b) IEC1000-4-2 Air-Discharge
- c) IEC1000-4-2 Direct Contact

The Human Body Model has been the generally accepted ESD testing method for semiconductors. This method is also specified in MIL-STD-883, Method 3015.7 for ESD testing. The premise of this ESD test is to simulate the human body's

potential to store electro-static energy and discharge it to an integrated circuit. The simulation is performed by using a test model as shown in *Figure 17*. This method will test the IC's capability to withstand an ESD transient during normal handling such as in manufacturing areas where the ICs tend to be handled frequently.

The IEC-1000-4-2, formerly IEC801-2, is generally used for testing ESD on equipment and systems. For system manufacturers, they must guarantee a certain amount of ESD protection since the system itself is exposed to the outside environment and human presence. The premise with IEC1000-4-2 is that the system is required to withstand an amount of static electricity when ESD is applied to points and surfaces of the equipment that are accessible to personnel during normal usage. The transceiver IC receives most of the ESD current when the ESD source is applied to the connector pins. The test circuit for IEC1000-4-2 is shown on *Figure 18*. There are two methods within IEC1000-4-2, the Air Discharge method and the Contact Discharge method.

With the Air Discharge Method, an ESD voltage is applied to the equipment under test (EUT) through air. This simulates an electrically charged person ready to connect a cable onto the rear of the system only to find an unpleasant zap just before the person touches the back panel. The high energy potential on the person discharges through an arcing path to the rear panel of the system before he or she even touches the system. This energy, whether discharged directly or through air, is predominantly a function of the discharge current rather than the discharge voltage. Variables with an air discharge such as approach speed of the object carrying the ESD potential to the system and humidity will tend to change the discharge current. For example, the rise time of the discharge current varies with the approach speed.

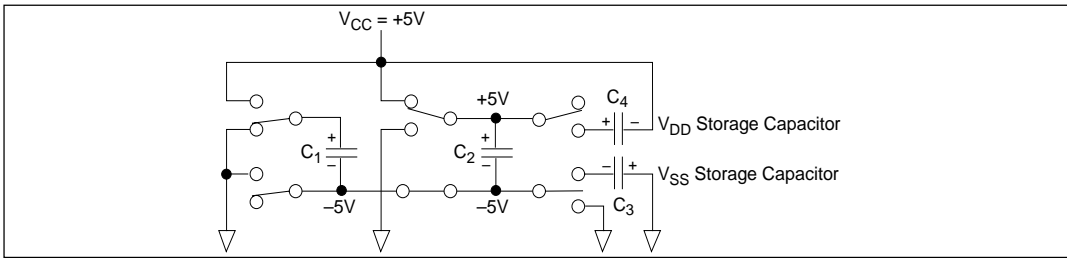


Figure 12. Charge Pump — Phase 1

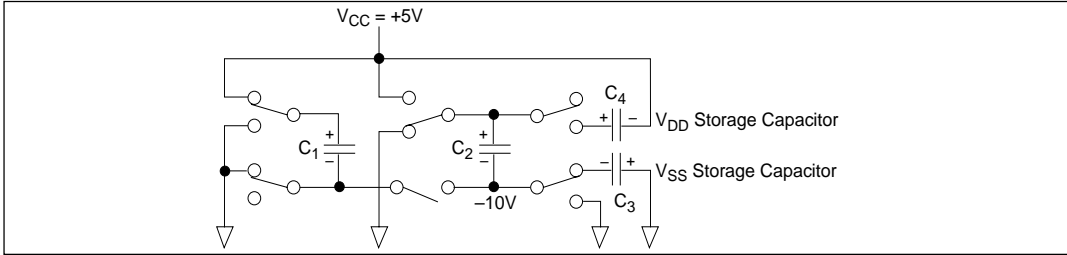


Figure 13. Charge Pump — Phase 2

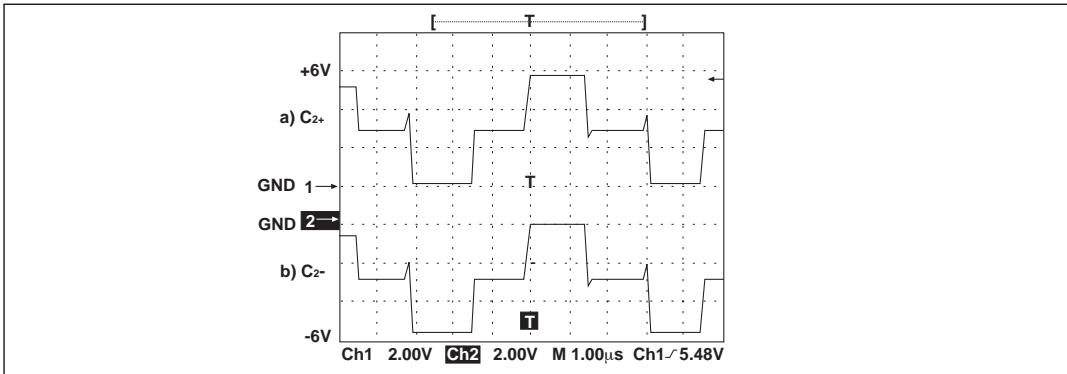


Figure 14. Charge Pump Waveforms

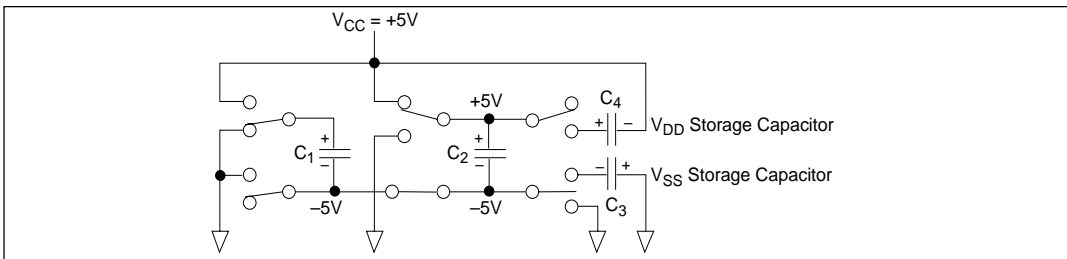


Figure 15. Charge Pump — Phase 3

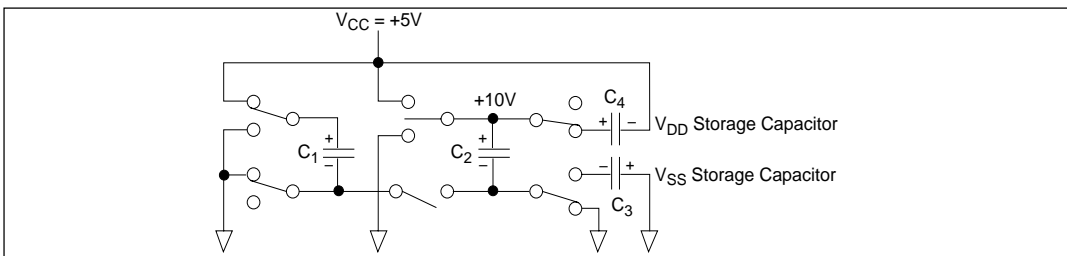


Figure 16. Charge Pump — Phase 4

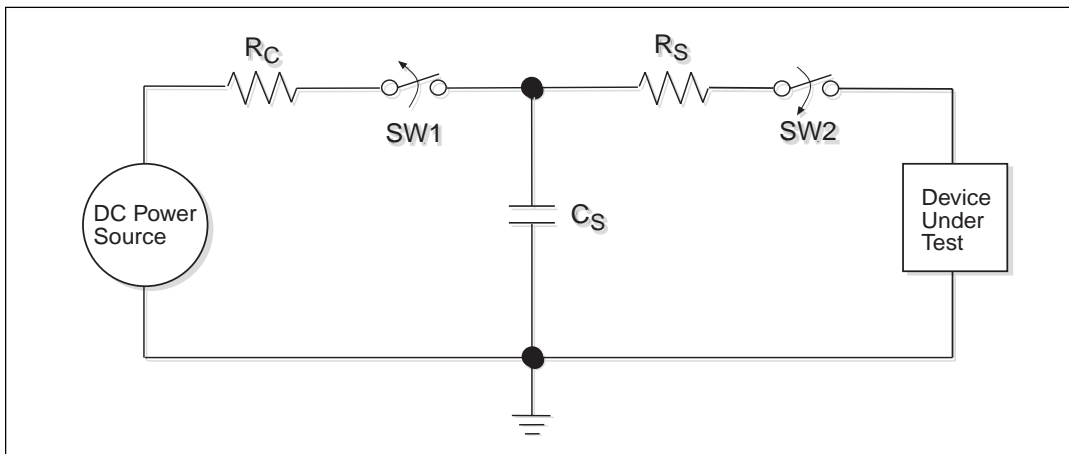


Figure 17. ESD Test Circuit for Human Body Model

The Contact Discharge Method applies the ESD current directly to the EUT. This method was devised to reduce the unpredictability of the ESD arc. The discharge current rise time is constant since the energy is directly transferred without the air-gap arc. In situations such as hand held systems, the ESD charge can be directly discharged to the equipment from a person already holding the equipment. The current is transferred on to the keypad or the serial port of the equipment directly and then travels through the PCB and finally to the IC.

The circuit models in Figures 17 and 18 represent the typical ESD testing circuits used for all three methods. The  $C_S$  is initially charged with the DC power supply when the first switch (SW1) is on. Now that the capacitor is charged, the second switch (SW2) is on while SW1 switches off. The voltage stored in the capacitor is then applied through  $R_S$ , the current limiting resistor, onto the device under test (DUT). In ESD tests, the SW2 switch is pulsed so that the device under test receives a duration of voltage.

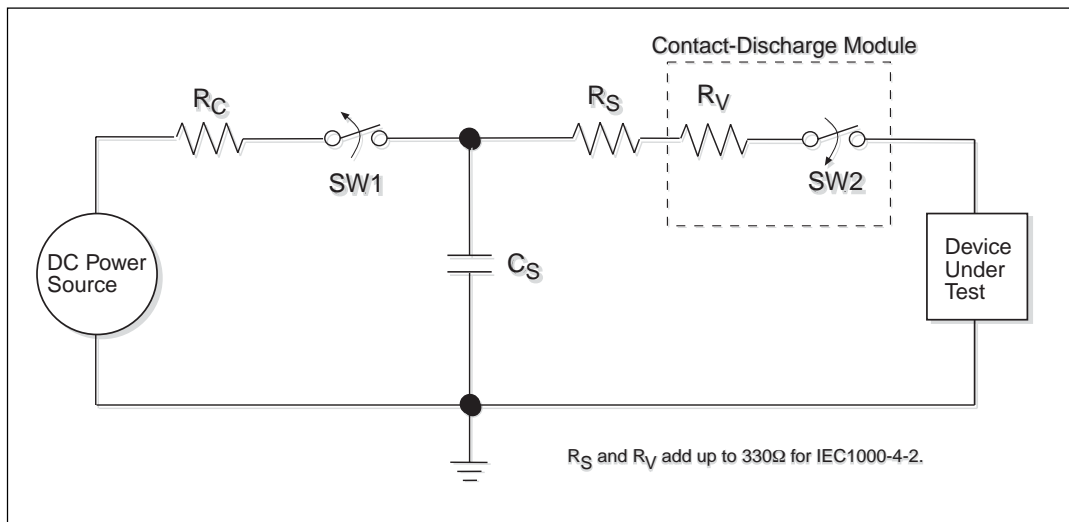


Figure 18. ESD Test Circuit for IEC1000-4-2

For the Human Body Model, the current limiting resistor ( $R_s$ ) and the source capacitor ( $C_s$ ) are  $1.5k\Omega$  and  $100pF$ , respectively. For IEC-1000-4-2, the current limiting resistor ( $R_s$ ) and the source capacitor ( $C_s$ ) are  $330\Omega$  and  $150pF$ , respectively.

The higher  $C_s$  value and lower  $R_s$  value in the IEC1000-4-2 model are more stringent than the Human Body Model. The larger storage capacitor injects a higher voltage to the test point when SW2 is switched on. The lower current limiting resistor increases the current charge onto the test point.

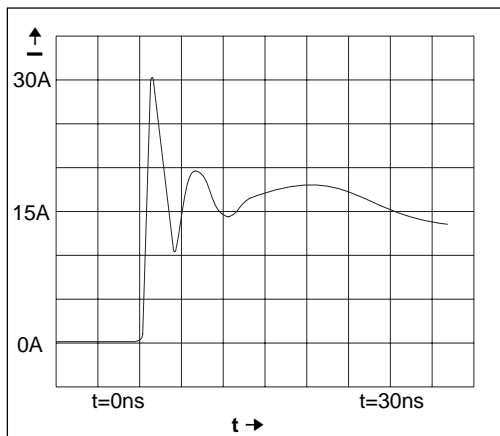
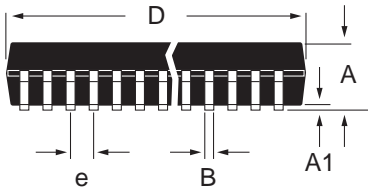
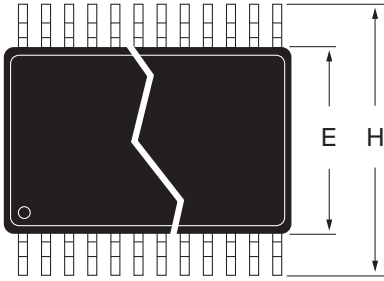


Figure 19. ESD Test Waveform for IEC1000-4-2

Device Pin Tested	Human Body Model	IEC1000-4-2		
		Air Discharge	Direct Contact	Level
Driver Outputs	$\pm 15kV$	$\pm 15kV$	$\pm 8kV$	4
Receiver Inputs	$\pm 15kV$	$\pm 15kV$	$\pm 8kV$	4

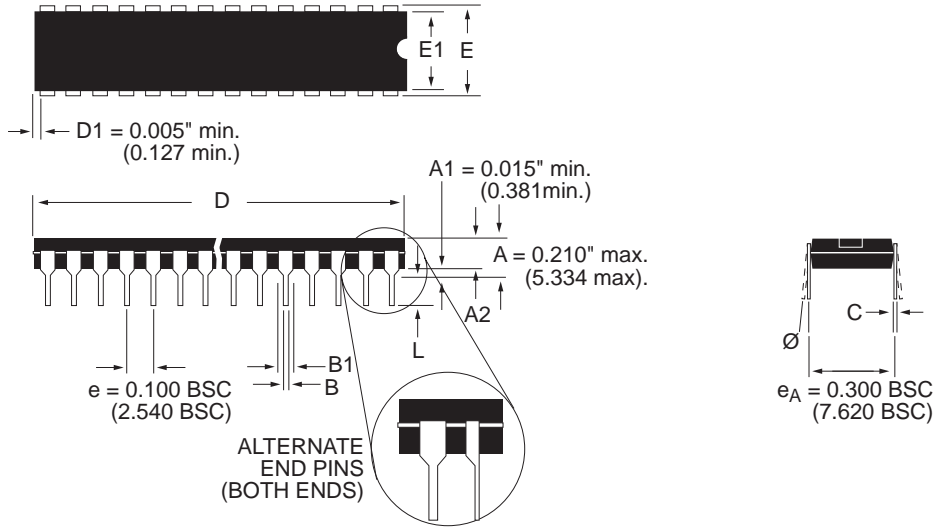
Table 3. Transceiver ESD Tolerance Levels

# PACKAGE: PLASTIC SHRINK SMALL OUTLINE (SSOP)



DIMENSIONS (Inches) Minimum/Maximum (mm)	16-PIN	20-PIN
A	0.068/0.078 (1.73/1.99)	0.068/0.078 (1.73/1.99)
A1	0.002/0.008 (0.05/0.21)	0.002/0.008 (0.05/0.21)
B	0.010/0.015 (0.25/0.38)	0.010/0.015 (0.25/0.38)
D	0.239/0.249 (6.07/6.33)	0.278/0.289 (7.07/7.33)
E	0.205/0.212 (5.20/5.38)	0.205/0.212 (5.20/5.38)
e	0.0256 BSC (0.65 BSC)	0.0256 BSC (0.65 BSC)
H	0.301/0.311 (7.65/7.90)	0.301/0.311 (7.65/7.90)
L	0.022/0.037 (0.55/0.95)	0.022/0.037 (0.55/0.95)
Ø	0°/8° (0°/8°)	0°/8° (0°/8°)

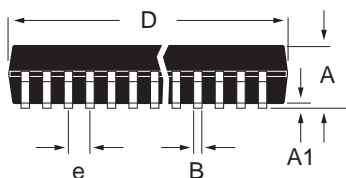
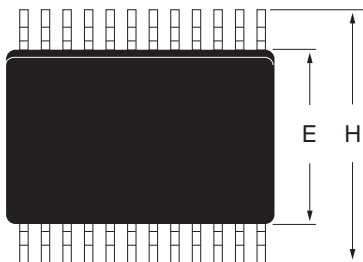
**PACKAGE: PLASTIC  
DUAL-IN-LINE  
(NARROW)**



DIMENSIONS (Inches) Minimum/Maximum (mm)	16-PIN	18-PIN
A2	0.115/0.195 (2.921/4.953)	0.115/0.195 (2.921/4.953)
B	0.014/0.022 (0.356/0.559)	0.014/0.022 (0.356/0.559)
B1	0.045/0.070 (1.143/1.778)	0.045/0.070 (1.143/1.778)
C	0.008/0.014 (0.203/0.356)	0.008/0.014 (0.203/0.356)
D	0.780/0.800 (19.812/20.320)	0.880/0.920 (22.352/23.368)
E	0.300/0.325 (7.620/8.255)	0.300/0.325 (7.620/8.255)
E1	0.240/0.280 (6.096/7.112)	0.240/0.280 (6.096/7.112)
L	0.115/0.150 (2.921/3.810)	0.115/0.150 (2.921/3.810)
$\varnothing$	0°/15° (0°/15°)	0°/15° (0°/15°)

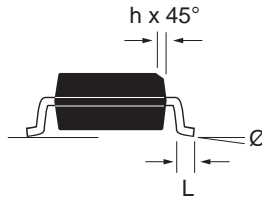
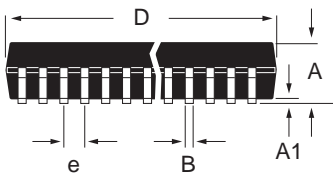
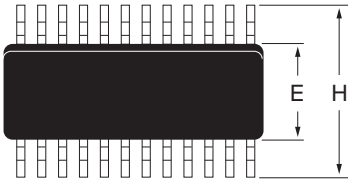


**PACKAGE: PLASTIC  
SMALL OUTLINE (SOIC)  
(WIDE)**



<b>DIMENSIONS (Inches) Minimum/Maximum (mm)</b>	<b>16-PIN</b>	<b>18-PIN</b>
<b>A</b>	<b>0.090/0.104 (2.29/2.649)</b>	<b>0.090/0.104 (2.29/2.649)</b>
<b>A1</b>	<b>0.004/0.012 (0.102/0.300)</b>	<b>0.004/0.012 (0.102/0.300)</b>
<b>B</b>	<b>0.013/0.020 (0.330/0.508)</b>	<b>0.013/0.020 (0.330/0.508)</b>
<b>D</b>	<b>0.398/0.413 (10.10/10.49)</b>	<b>0.447/0.463 (11.35/11.74)</b>
<b>E</b>	<b>0.291/0.299 (7.402/7.600)</b>	<b>0.291/0.299 (7.402/7.600)</b>
<b>e</b>	<b>0.050 BSC (1.270 BSC)</b>	<b>0.050 BSC (1.270 BSC)</b>
<b>H</b>	<b>0.394/0.419 (10.00/10.64)</b>	<b>0.394/0.419 (10.00/10.64)</b>
<b>L</b>	<b>0.016/0.050 (0.406/1.270)</b>	<b>0.016/0.050 (0.406/1.270)</b>
<b>∅</b>	<b>0°/8° (0°/8°)</b>	<b>0°/8° (0°/8°)</b>

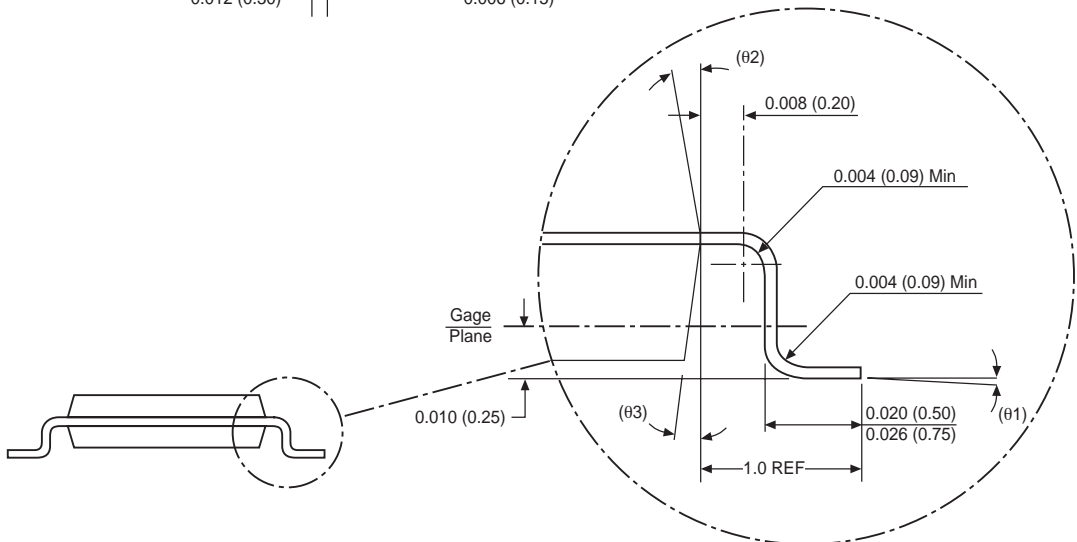
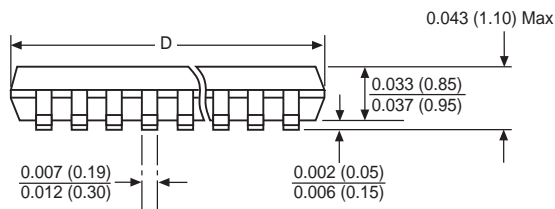
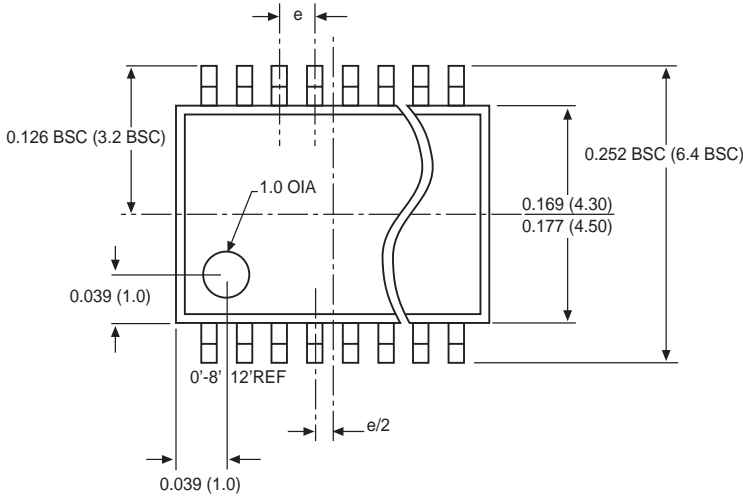
**PACKAGE: PLASTIC  
SMALL OUTLINE (SOIC)  
(NARROW)**



DIMENSIONS (Inches) Minimum/Maximum (mm)	16-PIN
A	0.053/0.069 (1.346/1.748)
A1	0.004/0.010 (0.102/0.249)
B	0.013/0.020 (0.330/0.508)
D	0.386/0.394 (9.802/10.000)
E	0.150/0.157 (3.802/3.988)
e	0.050 BSC (1.270 BSC)
H	0.228/0.244 (5.801/6.198)
h	0.010/0.020 (0.254/0.498)
L	0.016/0.050 (0.406/1.270)
Ø	0°/8° (0°/8°)

DIMENSIONS in inches (mm) Minimum/Maximum		
Symbol	16 Lead	20 Lead
D	0.193/0.201 (4.90/5.10)	0.252/0.260 (6.40/6.60)
e	0.026 BSC (0.65 BSC)	0.026 BSC (0.65 BSC)

## PACKAGE: PLASTIC THIN SMALL OUTLINE (TSSOP)



## ORDERING INFORMATION

Model	Temperature Range	Package Type
SP3222ECA .....	0°C to +70°C .....	20-Pin SSOP
SP3222ECP .....	0°C to +70°C .....	18-Pin PDIP
SP3222ECT .....	0°C to +70°C .....	18-Pin WSOIC
SP3222ECY .....	0°C to +70°C .....	20-Pin TSSOP
SP3222EEA .....	-40°C to +85°C .....	20-Pin SSOP
SP3222EEP .....	-40°C to +85°C .....	18-Pin PDIP
SP3222EET .....	-40°C to +85°C .....	18-Pin WSOIC
SP3222EEY .....	-40°C to +85°C .....	20-Pin TSSOP
SP3232ECA .....	0°C to +70°C .....	16-Pin SSOP
SP3232ECP .....	0°C to +70°C .....	16-Pin PDIP
SP3232ECT .....	0°C to +70°C .....	16-Pin WSOIC
SP3232ECN .....	0°C to +70°C .....	16-Pin nSOIC
SP3232ECY .....	0°C to +70°C .....	16-Pin TSSOP
SP3232EEA .....	-40°C to +85°C .....	16-Pin SSOP
SP3232EEP .....	-40°C to +85°C .....	16-Pin PDIP
SP3232EET .....	-40°C to +85°C .....	16-Pin WSOIC
SP3232EEN .....	-40°C to +85°C .....	16-Pin nSOIC
SP3232EEY .....	-40°C to +85°C .....	16-Pin TSSOP

Please consult the factory for pricing and availability on a Tape-On-Reel option.



SIGNAL PROCESSING EXCELLENCE

### Sipex Corporation

#### Headquarters and Sales Office

22 Linnell Circle  
 Billerica, MA 01821  
 TEL: (978) 667-8700  
 FAX: (978) 670-9001  
 e-mail: sales@sipex.com

#### Sales Office

233 South Hillview Drive  
 Milpitas, CA 95035  
 TEL: (408) 934-7500  
 FAX: (408) 935-7600

Sipex Corporation reserves the right to make changes to any products described herein. Sipex does not assume any liability arising out of the application or use of any product or circuit described hereing; neither does it convey any license under its patent rights nor the rights of others.