

# SONY®

3-286-586-11(1)

*Digital HD Video Camera Recorder*

## HANDYCAM®

### Operating Guide

### **HDR-SR11E/SR12E**

www.DataSheet4U.com

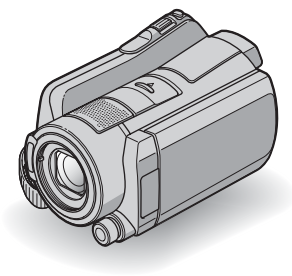

**AVCHD**



**HDMI**

For details on the advanced operations, please refer to  
“Handycam Handbook” (PDF).



www.DataSheet4U.com

# Read this first

Before operating the unit, please read this manual thoroughly, and retain it for future reference.

## WARNING

**To reduce fire or shock hazard, do not expose the unit to rain or moisture.**

**Do not expose the batteries to excessive heat such as sunshine, fire or the like.**



## CAUTION

**Replace the battery with the specified type only. Otherwise, fire or injury may result.**

**Excessive sound pressure from earphones and headphones cause hearing loss.**

## Notice for customers in the United Kingdom

A moulded plug complying with BS 1363 is fitted to this equipment for your safety and convenience.

Should the fuse in the plug supplied need to be replaced, a fuse of the same rating as the supplied one and approved by ASTA or BSI to BS 1362 (i.e., marked with an  or  mark) must be used.

If the plug supplied with this equipment has a detachable fuse cover, be sure to attach the fuse cover after you change the fuse. Never use the plug without the fuse cover. If you should lose the fuse cover, please contact your nearest Sony service station.

## FOR CUSTOMERS IN EUROPE

### ATTENTION

The electromagnetic fields at the specific frequencies may influence the picture and sound of this unit.

This product has been tested and found compliant with the limits set out in the EMC Directive for using connection cables shorter than 3 meters (9.8 feet).

### Notice

If static electricity or electromagnetism causes data transfer to discontinue midway (fail), restart the application or disconnect and connect the communication cable (USB, etc.) again.



**Disposal of Old Electrical & Electronic Equipment (Applicable in the European Union and other European countries with separate collection systems)**

This symbol on the product or on its packaging indicates that this product shall not be treated as household waste. Instead it shall be handed over to the applicable collection point for the recycling of electrical and electronic equipment.

By ensuring this product is disposed of correctly, you will help prevent potential negative consequences for the environment and human health, which could otherwise be caused by inappropriate waste handling of this product. The recycling of materials will help to conserve natural resources.

For more detailed information about recycling of this product, please contact your local Civic Office, your household waste disposal service or the shop where you purchased the product.

Applicable Accessory: Remote Commander



**Disposal of waste batteries  
(applicable in the European  
Union and other European  
countries with separate  
collection systems)**

This symbol on the battery or on the packaging indicates that the battery provided with this product shall not be treated as household waste.

By ensuring these batteries are disposed of correctly, you will help prevent potentially negative consequences for the environment and human health which could otherwise be caused by inappropriate waste handling of the battery. The recycling of the materials will help to conserve natural resources.

In case of products that for safety, performance or data integrity reasons require a permanent connection with an incorporated battery, this battery should be replaced by qualified service staff only. To ensure that the battery will be treated properly, hand over the product at end-of-life to the applicable collection point for the recycling of electrical and electronic equipment.

For all other batteries, please view the section on how to remove the battery from the product safely. Hand the battery over to the applicable collection point for the recycling of waste batteries.

For more detailed information about recycling of this product or battery, please contact your local Civic Office, your household waste disposal service or the shop where you purchased the product.

**Notice for the customers in the  
countries applying EU Directives**

The manufacturer of this product is Sony Corporation, 1-7-1 Konan Minato-ku Tokyo, 108-0075 Japan. The Authorized Representative for EMC and product safety is Sony Deutschland GmbH, Hedelfinger Strasse 61, 70327 Stuttgart, Germany. For any service or guarantee matters please refer to the addresses given in separate service or guarantee documents.

**For customers in the U.S.A.**

If you have any questions about this product, you may call:  
Sony Customer Information Center 1-800-222-SONY (7669).

The number below is for the FCC related matters only.

**Regulatory Information**

**Declaration of Conformity**

Trade Name: SONY

Model No.: HDR-SR11E

Responsible Party: Sony Electronics Inc.

Address: 16530 Via Esprillo, San Diego, CA 92127 U.S.A.

Telephone number: 858-942-2230

This device complies with Part 15 of the FCC Rules. Operation is subject to the following two conditions: (1) This device may not cause harmful interference, and (2) this device must accept any interference received, including interference that may cause undesired operation.

**Declaration of Conformity**

Trade Name: SONY

Model No.: HDR-SR12E

Responsible Party: Sony Electronics Inc.

Address: 16530 Via Esprillo, San Diego, CA 92127 U.S.A.

Telephone number: 858-942-2230

This device complies with Part 15 of the FCC Rules. Operation is subject to the following two conditions: (1) This device may not cause harmful interference, and (2) this device must accept any interference received, including interference that may cause undesired operation.

**Notes**

HDR-SR11E/HDR-SR12E is to be used with the Handycam Station Model DCRA-C210 and AC Adaptor Model AC-L200/L200B.

## CAUTION

You are cautioned that any changes or modifications not expressly approved in this manual could void your authority to operate this equipment.

## Note

This equipment has been tested and found to comply with the limits for a Class B digital device, pursuant to Part 15 of the FCC Rules.

These limits are designed to provide reasonable protection against harmful interference in a residential installation. This equipment generates, uses, and can radiate radio frequency energy and, if not installed and used in accordance with the instructions, may cause harmful interference to radio communications.

However, there is no guarantee that interference will not occur in a particular installation. If this equipment does cause harmful interference to radio or television reception, which can be determined by turning the equipment off and on, the user is encouraged to try to correct the interference by one or more of the following measures:

- Reorient or relocate the receiving antenna.
- Increase the separation between the equipment and receiver.
- Connect the equipment into an outlet on a circuit different from that to which the receiver is connected.
- Consult the dealer or an experienced radio/TV technician for help.

The supplied interface cable must be used with the equipment in order to comply with the limits for a digital device pursuant to Subpart B of Part 15 of FCC Rules.

## Battery pack

This device complies with Part 15 of the FCC Rules. Operation is subject to the following two conditions:

(1) This device may not cause harmful interference, and (2) this device must accept any interference received, including interference that may cause undesired operation.

## Notes on use

### Supplied items

The numbers in ( ) are the supplied quantity.



- AC Adaptor (1)
- Power cord (Mains lead) (1)
- Handycam Station (1) **A**
- Component A/V cable (1) **B**
- A/V connecting cable (1) **C**
- USB cable (1) **D**
- 21-pin adaptor (1)

For the models with the **CE** mark printed on their bottom surfaces only.

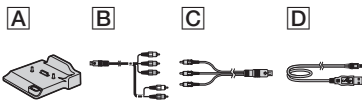
- Wireless Remote Commander (1)
- A button-type lithium battery is already installed.
- Rechargeable battery pack NP-FH60 (1)
  - CD-ROM “Handycam Application Software” (1) (p. 25)
    - Picture Motion Browser (Software)
    - PMB Guide
    - Handycam Handbook (PDF)
  - “Operating Guide” (This manual) (1)



### Using the camcorder

- The camcorder is not dustproofed, dripproofed or waterproofed. See “Precautions” (p. 31).
- Do not do any of the following when the  (Movie) or  (Still) mode lamps or the ACCESS lamps (p. 12, 16) are lit or flashing. Otherwise, the media may be damaged, recorded images may be lost or other malfunctions could occur.
  - Eject the “Memory Stick PRO Duo”
  - Remove the battery pack or AC Adaptor from the camcorder
  - Apply mechanical shock or vibration to the camcorder
- When connecting your camcorder to another device with communication cables, be sure to insert the connector plug in the correct way. Pushing the plug forcibly into the terminal will damage the terminal. [www.DataSheet4U.com](http://www.DataSheet4U.com) malfunction of your camcorder.

- Connect cables to the connectors of the Handycam Station when using your camcorder attached to the Handycam Station. Do not connect the cables to both the Handycam Station and your camcorder.
- Do not apply shock or vibration to your camcorder. The internal hard disk of the camcorder may not be recognized or recording/playback may not be possible.
- Do not use your camcorder in very loud areas. The hard disk of your camcorder may not be recognized, or recording may not be possible.
- To protect the internal hard disk from shock by dropping, the camcorder has drop sensor function\*. When a drop occurs, or under a non-gravity condition, the block noise made when this function is activated by the camcorder may also be recorded. If the drop sensor catches a drop repeatedly, recording/playback may be stopped.
- When the temperature of the camcorder becomes extremely high or extremely low, you may not be able to record or play back on the camcorder, due to the protection features of the camcorder being activated in such situations. In this case, a message appears on the LCD screen or in the viewfinder (p. 29).
- Do not turn on the camcorder in a low-pressure area, where the altitude is more than 3,000 meters (9,800 feet). Doing so may damage the hard disk drive of your camcorder.
- If you repeat recording/deleting images for a long time, fragmentation of data occurs on the media. Images cannot be saved or recorded. In such a case, save your images on some type of external media first, and then perform [MEDIA FORMAT]\*.
- Fasten the grip belt and hold your camcorder correctly while recording.

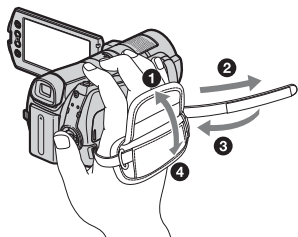

- To adjust the LCD panel, open the LCD panel 90 degrees to the camcorder (①), then rotate it to the best angle to record or play (②). You can rotate the LCD panel 180 degrees to the lens side (②) to record in mirror mode.

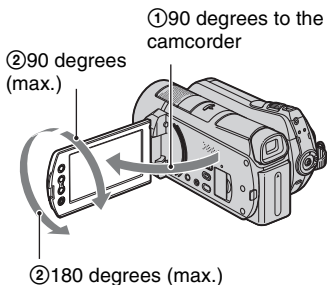

- The viewfinder and the LCD screen are manufactured using extremely high-precision technology, so over 99.99% of the pixels are operational for effective use. However, there may be some tiny black points and/or bright points (white, red, blue, or green in color) that appear constantly on the LCD screen. These points are normal results of the manufacturing process and do not affect the recording in any way.
- Remove the insulation sheet before using the Remote Commander.

Insulation sheet

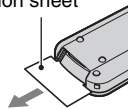

## Types of “Memory Stick” you can use with your camcorder

- For recording movies, it is recommended that you use a “Memory Stick PRO Duo” of 1 GB or larger marked with:
  - MEMORY STICK PRO DUO (“Memory Stick PRO Duo”)\*
  - MEMORY STICK PRO-HG DUO (“Memory Stick PRO-HG Duo”)

\* Marked with Mark2 or not, either can be used.
- A “Memory Stick PRO Duo” of up to 8 GB has been confirmed to operate correctly with this camcorder.

- See page 11 for the recordable time of a “Memory Stick PRO Duo.”
- “Memory Stick PRO Duo” and “Memory Stick PRO-HG Duo” are both called as “Memory Stick PRO Duo” in this manual.

## On recording

- Before starting to record, test the recording function to make sure the image and sound are recorded without any problems.
- Compensation for the contents of recordings cannot be provided, even if recording or playback is not possible due to a malfunction of the camcorder, recording media, etc.
- TV color systems differ depending on the country/region. To view your recordings on a TV, you need a PAL system-based TV.
- Television programs, films, video tapes, and other materials may be copyrighted. Unauthorized recording of such materials may be contrary to the copyright laws.

## On playing back recorded images on other devices

- Your camcorder is compatible with MPEG-4 AVC/H.264 High Profile for HD (high definition) image quality recording. Therefore, you cannot play back images recorded with HD (high definition) image quality on your camcorder with the following devices;
  - Other AVCHD format compatible devices which are not compatible with High Profile
  - Devices which are not compatible with the AVCHD format

## Save all your recorded image data

- To prevent your image data from being lost, save all your recorded images on external media periodically. It is recommended that you save the image data on a disc such as DVD-R using your computer\*. Also, you can save your image data using a VCR, or a DVD/HDD recorder\*.

## When the camcorder is connected to a computer

- Do not try to format the hard disk of the camcorder using a computer. If you do so, your camcorder may not operate correctly.

## Note on disposal/transfer

- Even if you perform [MEDIA FORMAT]\* or formatting the hard disk of the camcorder, you may not delete data from the hard disk completely. When you transfer the camcorder, it is recommended that you perform [⊖ EMPTY]\* to prevent the recovery of your data. Also, when you dispose of the camcorder, it is recommended that you destroy the actual body of the camcorder.

## About language setting

- The on-screen displays in each local language are used for illustrating the operating procedures. Change the screen language before using your camcorder if necessary (p. 10).

## About this manual

- The images of the LCD screen used in this manual for illustration purposes are captured using a digital still camera, and therefore may appear different from the actual images of the LCD screen.
- In this Operating Guide, the hard disk of your camcorder and “Memory Stick PRO Duo” are called “media.”
- The screenshots are from Windows Vista. The scenes may vary depending on the operating system of the computer.
- \* Refer also to “Handycam Handbook” (PDF) and “PMB Guide.”



# Table of Contents

Read this first .....	2
-----------------------	---

## Getting Started

Step 1: Charging the battery pack .....	8
Step 2: Turning the power on, and setting the date and time .....	10
Changing the language setting .....	10
Step 3: Selecting the media .....	11

## Recording/Playback

Recording .....	13
Playback .....	14
Playing the image on a TV .....	15
Name and functions of each part .....	16
Indicators displayed during recording/playback .....	18
Performing various functions - “  HOME” and “  OPTION” .....	20
Saving images .....	23
Deleting images .....	24

## Enjoying with a computer

Performing with a computer .....	25
Installing and viewing “Handycam Handbook” (PDF) .....	25
Installing “Picture Motion Browser” .....	25

## Troubleshooting

Troubleshooting .....	28
-----------------------	----

## Additional Information

Precautions .....	31
Specifications .....	33

# Step 1: Charging the battery pack

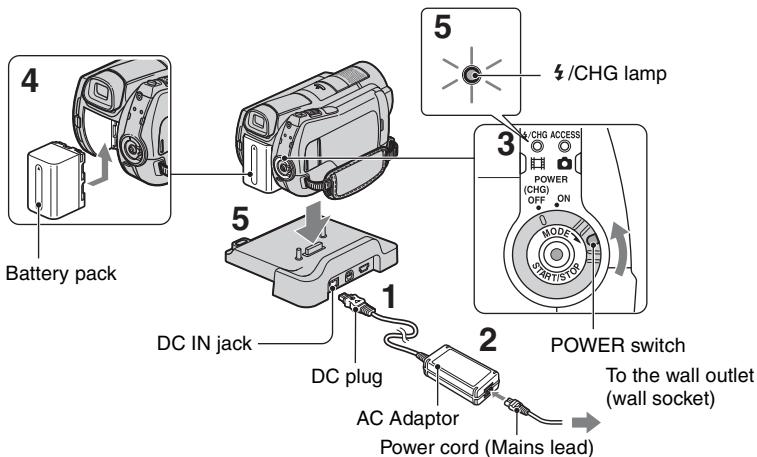

www.DataSheet4U.com

You can charge the “InfoLITHIUM” battery pack (H series) after attaching it to your camcorder.

## Notes

- You cannot attach any “InfoLITHIUM” battery pack other than the H series to your camcorder.

### 1 Connect the AC Adaptor to the DC IN jack on the Handycam Station.

Be sure that the ▲ mark on the DC plug is facing up.

### 2 Connect the power cord (mains lead) to the AC Adaptor and the wall outlet (wall socket).

### 3 Turn the POWER switch in the direction of the arrow to OFF (CHG) (the default setting).

### 4 Attach the battery pack by sliding it in the direction of the arrow until it clicks.

### 5 Set the camcorder onto the Handycam Station securely.

The ⚡/CHG (charge) lamp lights up and charging starts. The ⚡/CHG (charge) lamp turns off when the battery pack is fully charged. Remove the camcorder from the Handycam Station.

### To remove the battery pack

Turn the POWER switch to OFF (CHG). Slide the BATT (battery release) lever and remove the battery pack.

BATT (battery release) lever

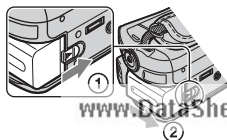

www.DataSheet4U.com



## To charge the battery pack using only the AC Adaptor

Turn the POWER switch to OFF (CHG), then connect the AC Adaptor directly to the DC IN jack on the camcorder.

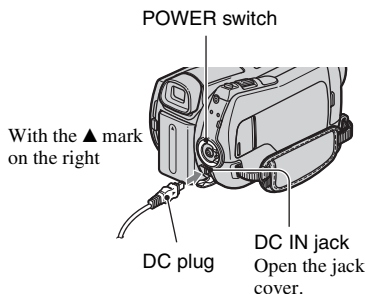

## Available running time for the supplied battery pack

**Charging time:**

Approximate time (min.) required when you fully charge a completely exhausted battery pack.

**Recording/Playback time:**

Approximate time (min.) available when you use a fully charged battery pack.

“HD” stands for high definition image quality, and “SD” stands for standard image quality.

(Unit:min.)



	Hard disk		“Memory Stick PRO Duo”	
	HD	SD	HD	SD
Charging time	135			
Recording time*1*2				
Continuous recording time	90	110	90	110
Typical recording time*3	40	50	40	50
Playback time*2	130	130	140	140

\*1 [REC MODE]: SP

\*2 When the LCD backlight is on

\*3 Typical recording time shows the time when you repeat recording start/stop, turning the power on/off and zooming.

## On the battery pack

- When you remove the battery pack or disconnect the AC Adaptor, turn the POWER switch to OFF (CHG) and make sure that the  (Movie) lamp/ (Still) lamp (p. 10)/ACCESS lamps (p. 12, 16) are turned off.
- The power will not be supplied from the battery as long as the AC Adaptor is connected to the DC IN jack of your camcorder or the Handycam Station, even when the power cord (mains lead) is disconnected from the wall outlet (wall socket).

## On the charging/recording/playback time

- Times measured when using the camcorder at 25°C (77°F) (10°C to 30°C (50°F to 86°F) is recommended).
- The available recording and playback time will be shorter when you use your camcorder in low temperatures.
- The available recording and playback time will be shorter depending on the conditions under which you use your camcorder.

## On the AC Adaptor

- Use the nearby wall outlet (wall socket) when using the AC Adaptor. Disconnect the AC Adaptor from the wall outlet (wall socket) immediately if any malfunction occurs while using your camcorder.
- Do not use the AC Adaptor placed in a narrow space, such as between a wall and furniture.
- Do not short-circuit the DC plug of the AC Adaptor or battery terminal with any metallic objects. This may cause a malfunction.
- Even if your camcorder is turned off, AC power source (mains) is still supplied to it while connected to the wall outlet (wall socket) via the AC Adaptor.

# Step 2: Turning the power on, and setting the date and time

↑ (HOME) (p. 20)

Touch the button on the LCD screen.

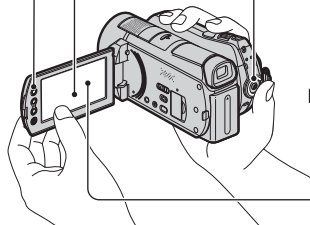

POWER switch

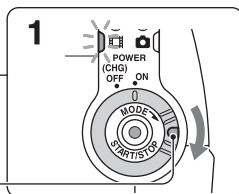

2

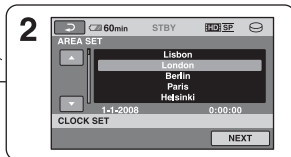

When using the camcorder for the first time, the [CLOCK SET] screen appears on the LCD screen.

**1** While pressing the green button, turn the **POWER** switch repeatedly in the direction of the arrow until the respective lamp lights up.

(Movie): To record movies

(Still): To record still images

Go to step **3** when you turn on your camcorder for the first time.

- When you turn on (Still) lamp, the screen aspect ratio is changed to 4:3 automatically.

**2** Touch (HOME) → (SETTINGS) → [CLOCK/LANG] → [CLOCK SET].

**3** Select the desired geographical area with / , then touch [NEXT].

**4** Set [SUMMERTIME], [Y] (year), [M] (month), [D] (day), hour and minute, then touch [OK].



The clock starts.

## Tips

- The date and time does not appear during recording, but they are automatically recorded on the media, and can be displayed during playback.
- You can turn off the operation beeps by touching (HOME) → (SETTINGS) → [SOUND/DISP SET] → [BEEP] → [OFF].

## Changing the language setting

You can change the on-screen displays to show messages in a specified language. Touch (HOME) → (SETTINGS) → [CLOCK/LANG] → [LANGUAGE SET], then select the desired language.

## Step 3: Selecting the media

You can select the hard disk or “Memory Stick PRO Duo” as the recording/playback/editing media on your camcorder. Select the media for movies and still images separately.

The default setting is hard disk for movies and still images.

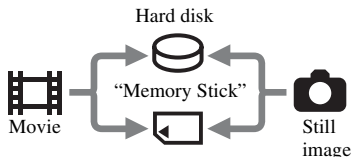

### Notes

- You can do recording/playback/editing operations for the selected media. When you want to change media, reselect the media.
- The recordable time with [HD SP] recording mode (the default setting) is as follows:
  - On the internal hard disk: approx. 17 h 50 m (HDR-SR11E), approx. 36 h (HDR-SR12E)
  - On a “Memory Stick PRO Duo” (4 GB) made by Sony Corporation: approx. 1 h 5 m

### Tips

- Check the number of recordable still images on the LCD screen of your camcorder (p. 18).

## 1 Touch (HOME) → (MANAGE MEDIA).



## 2 Touch [MOVIE MEDIA SET] to select the media for movies.

The media setting screen appears.

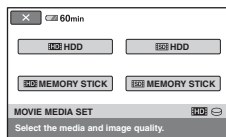

## 3 Touch the desired media and image quality.

indicates HD (high definition) image quality, and indicates SD (standard definition) image quality.

## 4 Touch [YES] → [OK].

The media is changed.

## To select the media for still images

Touch [PHOTO MEDIA SET] in step 2, then touch the desired media.

## To check the media setting

- Turn the POWER switch repeatedly to light up the (Movie)/ (Still) lamp, depending on which media setting you want to check.
- Check the media icon on the screen.

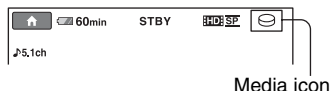

: Hard disk

: “Memory Stick PRO Duo”

## Inserting a “Memory Stick PRO Duo”

Insert a “Memory Stick PRO Duo” if “Memory Stick PRO Duo” has been selected as the media.

For types of “Memory Stick” you can use in your camcorder, see page 5.

---

## 1 Insert the “Memory Stick PRO Duo.”

- 1 Open the Memory Stick Duo cover in the direction of the arrow.
- 2 Insert the “Memory Stick PRO Duo” into the Memory Stick Duo slot in the right direction until it clicks.
- 3 Close the Memory Stick Duo cover.

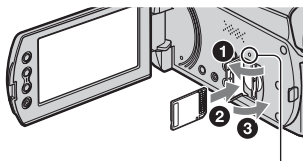

ACCESS lamp (“Memory Stick PRO Duo”)

---

## 2 If you have selected “Memory Stick PRO Duo” as the movie media, turn the POWER switch until the (Movie) lamp lights up.

If the POWER switch is set to OFF (CHG), turn it on while pressing the green button.

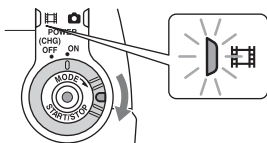

The [Create a new Image Database File.] screen appears on the LCD screen when you insert a new “Memory Stick PRO Duo.”

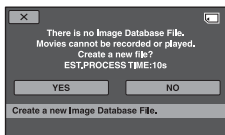

---

## 3 Touch [YES].

To record only still images on a “Memory Stick PRO Duo,” touch [NO].

---

## To eject the “Memory Stick PRO Duo”

Open the Memory Stick Duo cover and lightly push the “Memory Stick PRO Duo” in once.

### Notes

- Do not open the Memory Stick Duo cover during recording.
- If you force the “Memory Stick PRO Duo” into the slot in the wrong direction, the “Memory Stick PRO Duo,” the Memory Stick Duo slot, or image data may be damaged.
- If [Failed to create a new Image Database File. It may be possible that there is not enough free space.] is displayed in step 3, format the “Memory Stick PRO Duo.” Note that formatting will delete all data recorded on the “Memory Stick PRO Duo.”
- When inserting or ejecting the “Memory Stick PRO Duo,” be careful so that the “Memory Stick PRO Duo” does not pop out and drop.

# Recording

The images are recorded on the media selected in the media setting (p. 11). In the default setting, both movies and still images are recorded on the hard disk.

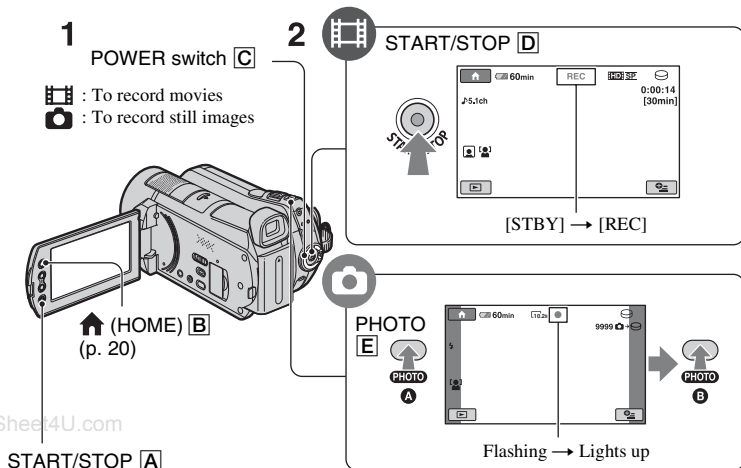

## 1 Turn the POWER switch [C] until the respective lamp lights up.

Press the green button only when the POWER switch [C] is in the OFF (CHG) position.

## 2 Start recording.

### Movies



Press START/STOP [D] (or [A]).

To stop recording, press START/STOP [D] (or [A]) again.

### Still Images



Press PHOTO [E] lightly to adjust the focus **A** (a beep sounds), then press it fully **B** (a shutter click sounds).

appears beside or . When disappears, the image has been recorded.

### Tips

- You can check the recordable time and the remaining capacity by pressing (HOME) [B] → (MANAGE MEDIA) → [MEDIA INFO].
- You can capture still images by pressing PHOTO [E] during movie recording.
- The maximum continuous recordable time of movies is approximately 13 hours.

- When a movie file exceeds 2 GB, the next movie file is created automatically.

# Playback

You can play back the image recorded in the media that has been set on the media setting (p. 11). In the default setting, the images on the hard disk are played back.

▶ (VIEW IMAGES) **A**

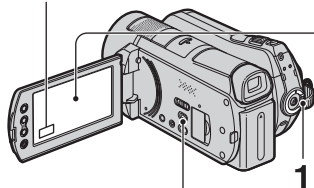

POWER switch **B**

▶ (VIEW IMAGES) **C**

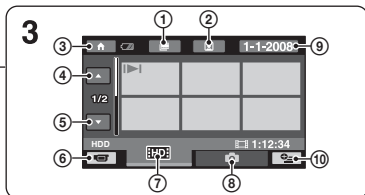

- ① Goes to the (Film Roll Index) screen
- ② Goes to the (Face Index) screen
- ③ Goes to (HOME)
- ④ Previous 6 images
- ⑤ Next 6 images
- ⑥ Returns to the recording screen

- ⑦ Displays movies with HD (high definition) image quality\*
- ⑧ Displays still images
- ⑨ Searches for images by date
- ⑩ (OPTION)

\* appears when you select the movie with SD (standard definition) image quality in [MOVIE MEDIA SET] (p. 11).

www.DataSheet4U.com

**1** Turn the POWER switch **B** to turn on your camcorder.

**2** Press ▶ (VIEW IMAGES) **C** (or **A**).

The VISUAL INDEX screen appears on the LCD screen (It may take some seconds).

**3** Start playback.

## Movies



Touch the or tab, then select the desired movie to play back.

Beginning of the movie/previous movie      Toggles Play or Pause as you touch      Next movie

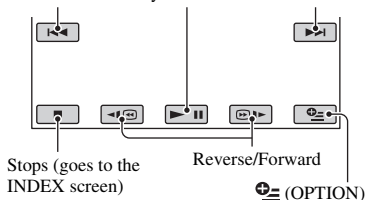

## Still Images



Touch the tab, then select the desired still image to play back.

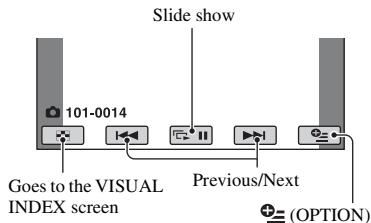

www.DataSheet4U.com

## To adjust the sound volume of movies

When playing back a movie, touch (OPTION) → tab → [VOLUME], then adjust the volume with / .

### Tips

- On the VISUAL INDEX screen, appears with the image on the tab that was most recently played back/recorded. When you touch an image marked with , you can play it back from the point it was previously stopped.

## Playing the image on a TV

Connection methods and quality of the image (HD (high definition)/SD (standard definition)) viewed on the TV screen differ depending on what type of TV is connected, and the connectors used.

Use the supplied AC Adaptor as the power source (p. 8).

Refer also to the instruction manuals supplied with the device to be connected.

### Notes

- When recording, set [X.V.COLOR] to [ON] to play back on an x.v.Color-compliant TV. Some settings may need to be adjusted on the TV when playing back. Refer to the instruction manual of your TV for details.

## Operation flow

### Switch the input on the TV to the connected jack.

Refer to the instruction manuals of the TV.

### Connect your camcorder and TV referring to [TV CONNECT Guide].

Touch (HOME) → (OTHERS) → [TV CONNECT Guide].

### Make the required output settings on your camcorder.

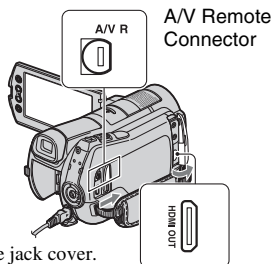
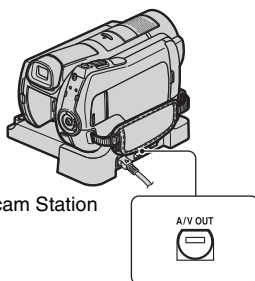

Open the jack cover.

### Notes

- When the A/V connecting cable is used to output images, images are output with SD (standard definition) image quality.
- Your camcorder and the Handycam Station are equipped with A/V Remote Connector or A/V OUT jack (p. 16). Connect the A/V connecting cable or component A/V cable either to the Handycam Station or to your camcorder. If you connect A/V connecting cables or component A/V cable to both the Handycam Station and your camcorder at the same time, image disturbance may occur.

# Name and functions of each part

Buttons, jacks, etc., which are not explained in other chapters, are explained here.

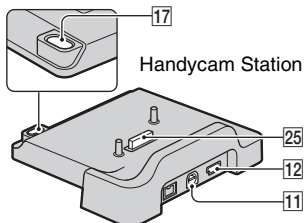
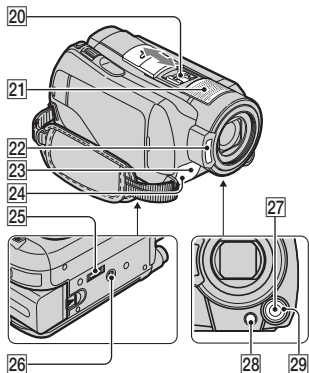
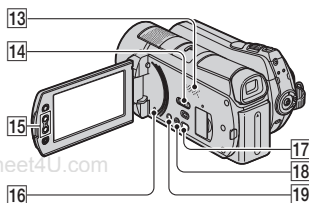
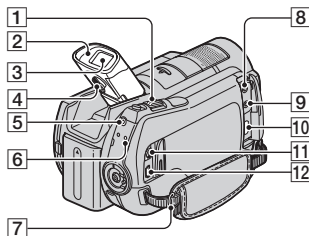

## Recording/Playback

### 1 Power zoom lever

Move the power zoom lever slightly for a slower zoom. Move it further for a faster zoom.

You can magnify still images from about 1.1 to 5 times the original size (Playback zoom).

- When you touch the screen during playback zoom, the point you touched will be displayed in the center of the LCD screen.

### 2 Eyecup

### 3 Viewfinder

You can view images on the viewfinder with the LCD panel closed. The viewfinder is useful when you want to avoid wearing down the battery, or when the image seen on the LCD panel is poor.

### 4 Viewfinder lens adjustment lever

Move up the viewfinder and move the viewfinder lens adjustment lever until the image is clear.

### 5 QUICK ON button

When you press QUICK ON, the camcorder goes to sleep mode (power saving mode) instead of turning off. The QUICK ON lamp keeps flashing during sleep mode. Press QUICK ON again to start recording next time. Your camcorder returns to recording standby in approximately 1 second.

The power turns off automatically if you do not operate your camcorder for a certain period during sleep mode.

### 6 ACCESS lamp (Hard disk)

When the ACCESS lamp is lit or flashing, your camcorder is writing/reading data.

### 7 Hook for a shoulder belt

Attach the shoulder belt (optional).

### 13 Speaker

### 14 NIGHTSHOT switch

Set the NIGHTSHOT switch to ON (☐ appears) to record in dark places.



**15 Zoom buttons**

Press for zooming in/out.

You can magnify still images from about 1.1 to 5 times the original size (Playback zoom).

- When you touch the screen during playback zoom, the point you touched will be displayed in the center of the LCD screen.

**16 RESET button**

Press RESET to initialize all the settings including the clock setting.

**18 EASY button**

Press EASY to display **EASY** and most of the settings are set automatically for easy recording/playback. To cancel, press EASY again.

**19 DISP/BATT INFO button**



You can switch the screen display when you press while the power is set to on. When you press while the POWER switch is set to OFF (CHG), you can check the remaining battery.

**21 Built-in microphone**

Sound picked up by the internal microphone is converted to 5.1ch surround sound and recorded.

**22 Flash**

The flash will flash automatically depending on recording conditions in the default setting.

Touch  (HOME) →  (SETTINGS) → [PHOTO SETTINGS] → [FLASH MODE] to change the setting.

**23 Remote sensor/Infrared port**

Receives the signal from the Remote Commander.

**24 Camera recording lamp**

The camera recording lamp lights up in red during recording. The lamp flashes when the remaining media capacity or battery power is low.

**26 Tripod receptacle (Bottom surface)**



Attach a tripod (optional) to the tripod receptacle using a tripod screw (optional:

the length of the screw must be less than 5.5 mm (7/32 in.)).

**27 MANUAL button**

You can display the [DIAL SETTING] screen with pressing and holding the manual button.

**28  (back light) button**

Press  (back light) to display  for adjusting the exposure for backlit subject. Press  (back light) again to cancel the backlight function.

**29 CAM CTRL dial**

You can use the menu item assigned on the [DIAL SETTING] screen.

## Connecting to other devices

**8 MIC (PLUG IN POWER) jack**

When an external microphone (optional) is connected, it takes precedence over the Built-in microphone (p. 17).

**9  (headphones) jack****10 HDMI OUT (mini) jack**

Connect with the HDMI cable (optional).

**11 A/V Remote Connector/A/V OUT jack**

Connect with the component A/V cable or A/V connecting cable.

**12  (USB) jack**

Connect with the USB cable.

**17  (DISC BURN) button**

Create a disc by connecting the camcorder to a computer, etc. For details, see “PMB Guide” (p. 27).

**20 Active Interface Shoe **

The Active Interface Shoe supplies power to optional accessories such as a video light, a flash, or a microphone. The accessory can be turned on or off as you operate the POWER switch on your camcorder.

**25 Interface connector**

Connect your camcorder and the Handycam Station.

# Indicators displayed during recording/playback

## Recording movies

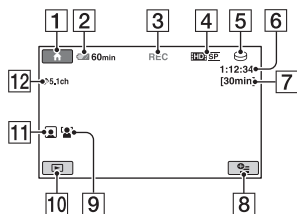

## Recording still images

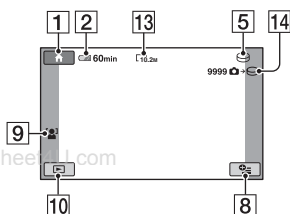

## Viewing movies

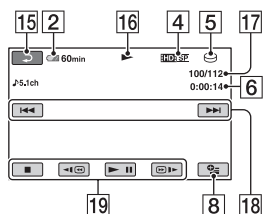

## Viewing still images

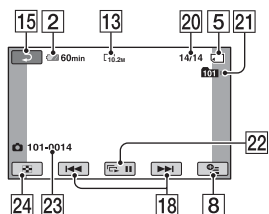

- 1 HOME button
- 2 Remaining battery (approx.)
- 3 Recording status ([STBY] (standby) or [REC] (recording))
- 4 Recording quality (HD/SD) and Recording mode (FH/HQ/SP/LP)
- 5 Recording/playback media
- 6 Counter (hour/minute/second)
- 7 Recording remaining time
- 8 OPTION button
- 9 FACE DETECTION
- 10 VIEW IMAGES button
- 11 Face Index set
- 12 5.1ch surround recording
- 13 Image size
- 14 Approximate number of recordable still images and media/During still image recording
- 15 Return button
- 16 Playback mode
- 17 Current playing movie number/Number of total recorded movies
- 18 Previous/Next button
- 19 Video operation buttons
- 20 Current playing still image number/ Number of total recorded still images
- 21 Playback folder  
Displays only when the playback media of still images is a "Memory Stick PRO Duo."
- 22 Slide show button
- 23 Data file name
- 24 VISUAL INDEX button

## Indicators when you made changes

Following indicators appear during recording/playback to indicate the settings of your camcorder.

Upper left      Center      Upper right

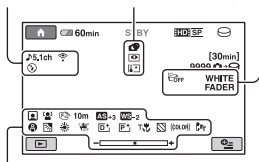

Bottom

### Upper left

Indicator	Meaning
	AUDIO MODE
	Self-timer recording
	Flash, REDEYE REDUC
	BLT-IN ZOOM MIC
	MICREF LEVEL low
	WIDE SELECT

### Center

Indicator	Meaning
	IMAGE SIZE
	Slide show set
	NightShot
	Super NightShot
	Color Slow Shutter
	PictBridge connecting
	Warning

### Upper right

Indicator	Meaning
	FADER
	LCD backlight off
	Drop sensor off
	Drop sensor activated
	Media for still images

### Bottom





Indicator	Meaning
	Face Index
	FACE DETECTION
	Picture effect
	Digital effect
	Manual focus
	SCENE SELECTION
	Backlight
	White balance
	SteadyShot off
	EXPOSURE/ SPOT METER
	AE SHIFT
	WB SHIFT
	TELE MACRO
	ZEBRA
	X.V.COLOR
	CONVERSION LENS

### Tips

- Indicators and their positions are approximate and differ from what you actually see. See "Handycam Handbook" (PDF) for details.
- The recording date and time is recorded automatically on the media. They are not displayed while recording. However, you can check them as [DATA CODE] during playback.



[www.DataSheet4U.com](http://www.DataSheet4U.com)

# Performing various functions - “ HOME” and “ OPTION”

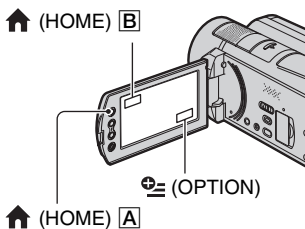
You can display the menu screen by pressing  (HOME)  (or ) /  (OPTION). For details of the menu items, see “Handycam Handbook” (PDF) (p. 25).



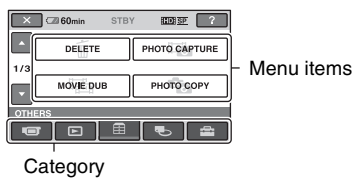

## Using the HOME MENU

You can change the operating settings for your convenience. Press  (HOME)  (or ) to display the menu screen.







- 1 Touch the desired category then item to change the setting.
- 2 Follow the instructions on the screen.

### Tips

- If the item is not on the screen, touch  /  to change the page.
- To hide the HOME MENU screen, touch .
- You cannot simultaneously select or activate the grayed items in the current recording/playback situation.



## To see the explanation of the HOME MENU (HELP)

- ① Press  (HOME)  (or ) .
  - ② Touch  (HELP).
- The bottom of  (HELP) turns orange.



- ③ Touch the item you want to learn about. When you touch an item, its explanation appears on the screen. To apply the selected item, touch [YES].

## Using the OPTION MENU

The  (OPTION) MENU appears just like the pop-up window that appears when you right-click the mouse on a computer. Press  (OPTION) to display the menu items you can change in the current situation.

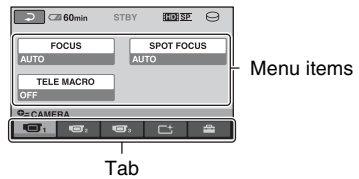

- 1 Touch the desired tab then item to change the setting.
- 2 After completing the setting, touch .

## Notes

- When the item you want is not on the screen, touch another tab. If you cannot find the item anywhere, the function is not available under the current situation.
- The  (OPTION) MENU cannot be used during Easy Handycam operation.

## Items of the HOME MENU

### (CAMERA) category

MOVIE\*

PHOTO\*

SMTH SLW  
REC

### (VIEW IMAGES) category

VISUAL  
INDEX\*

 INDEX\*

 INDEX\*

PLAYLIST

### (OTHERS) category











DELETE\*  DELETE],  
 DELETE]

PHOTO  
CAPTURE

MOVIE DUB   →  DUB],  
  →  DUB]

PHOTO  
COPY [COPY by select], [COPY by  
date]

EDIT  DELETE],  
 DELETE], [DIVIDE]

PLAYLIST  ADD],  ADD],  
EDIT  ADD by date],  
 ADD by date],  
 ERASE],  ERASE],  
 ERASE ALL],  
 ERASE ALL],  
 MOVE],  MOVE]

PRINT

USB  
CONNECT  USB CONNECT],  
 USB CONNECT], [DISC  
BURN]

TV  
CONNECT  
Guide\*

### (MANAGE MEDIA) category

MOVIE  
MEDIA  
SET\*

PHOTO  
MEDIA  
SET\*

MEDIA  
INFO

MEDIA [HDD], [MEMORY STICK]  
FORMAT\*

REPAIR [HDD], [MEMORY STICK]  
IMG.DB F.

### (SETTINGS) category





MOVIE [REC MODE], [AUDIO  
SETTINGS MODE], [AE SHIFT], [WB  
SHIFT], [NIGHTSHOT  
LIGHT], [WIDE SELECT],  
[DIGITAL ZOOM],  
[STEADYSHOT], [AUTO  
SLW SHUTTR],  
[X.V.COLOR],  
[GUIDEFAME], [ZEBRA],  
 REMAINING SET],  
[SUB-T DATE], [FLASH  
MODE]\*, [FLASH LEVEL],  
[REDEYE REDUC], [DIAL  
SETTING], [FACE  
DETECTION], [ INDEX  
SET]\*, [CONVERSION  
LENS]

PHOTO [  IMAGE SIZE]\*, [FILE  
SETTINGS NO.], [AE SHIFT], [WB  
SHIFT], [NIGHTSHOT  
LIGHT], [STEADYSHOT],  
[GUIDEFAME], [ZEBRA],  
[FLASH MODE]\*, [FLASH  
LEVEL], [REDEYE REDUC],  
[DIAL SETTING], [FACE  
DETECTION],  
[CONVERSION LENS]

VIEW [DATA CODE],  
IMAGES  DISPLAY]  
SET

www.DataSheet4U.com

SOUND/ DISP SET**	[VOLUME]*, [BEEP]*, [LCD BRIGHT], [LCD BL LEVEL], [LCD COLOR], [VF B.LIGHT]
OUTPUT SETTINGS	[TV TYPE], [DISP OUTPUT], [COMPONENT]
CLOCK/  LANG	[CLOCK SET]*, [AREA SET], [SUMMERTIME], [  LANGUAGE SET]*
GENERAL SET	[DEMO MODE], [REC LAMP], [CALIBRATION], [A.SHUT OFF], [QUICK ON STBY], [REMOTE CTRL], [DROP SENSOR], [CTRL FOR HDMI]

\* You can set these items also during Easy Handycam operation.

\*\*The menu name is changed to [SOUND SETTINGS] during Easy Handycam operation.

## Items of the OPTION MENU

Items you can set only on the OPTION MENU will be described below.

 tab

[FOCUS], [SPOT FOCUS], [TELE MACRO],  
[EXPOSURE], [SPOT METER], [SCENE  
SELECTION], [WHITE BAL.], [COLOR  
SLOW SHTR], [SUPER NIGHTSHOT]

 tab

[FADER], [D.EFFECT], [PICT.EFFECT]

 tab

[BLT-IN ZOOM MIC], [MICREF LEVEL],  
[SELF-TIMER], [TIMING], [RECORD  
SOUND]

– (The tab depends on the situation/No tab)

[SLIDE SHOW], [SLIDE SHOW SET],  
[COPIES], [DATE/TIME], [SIZE]

# Saving images

Due to the limited capacity of the media, make sure that you save the image data to some type of external media such as a DVD-R or a computer.

You can save the images recorded on the camcorder as described below.

## Using a computer

By using “Picture Motion Browser” on the supplied CD-ROM, you can save the images recorded on your camcorder with HD (high definition) image quality or SD (standard definition) image quality.

You can rewrite movies with HD (high definition) image quality from the computer to your camcorder, if necessary. For details, see “PMB Guide” (p. 27).

## Creating a disc with One Touch (One Touch Disc Burn)

You can save images recorded on the hard disk of your camcorder directly to a disc with ease by pressing the  (DISC BURN) button.

## Saving images on a computer (Easy PC Back-up)

You can save images recorded on the camcorder on the hard disk of a computer.

## Creating a disc with selected images

You can save images copied to your computer on a disc. You can also edit those images.

## Connecting your camcorder to other devices

For details, see “Handycam Handbook” (PDF).



## Connecting with the A/V connecting cable

You can dub to VCRs, DVD/HDD recorders with SD (standard definition) image quality.

## Connecting with the USB cable

You can dub to movie dubbing compatible DVD writers, etc., with HD (high definition) image quality.



### Tips

- You can dub movies or copy still images from the hard disk to a “Memory Stick PRO Duo.”  
Touch  (HOME) →  (OTHERS) → [MOVIE DUB]/[PHOTO COPY].

# Deleting images

Select the media which contains the image you want to delete before the operation (p. 11).

## Deleting movies

**1** Touch  (HOME) →   
(OTHERS) → [DELETE].



**2** Touch [] DELETE].

**3** Touch [] DELETE] or [] DELETE], then touch the movie to be deleted.

The selected movie is marked with ✓.

**4** Touch [OK] → [YES] → [OK].

### To delete all movies at one time

In step **3**, touch [] DELETE ALL]/[] DELETE ALL] → [YES] → [YES] → [OK].

### To delete still images

① In step **2**, touch [] DELETE].

② Touch [] DELETE], then touch the still image to be deleted.

The selected still image is marked with ✓.

③ Touch [OK] → [YES] → [OK].

### 💡 Tips

- To delete all still images on the media, in step ②, touch [] DELETE ALL] → [YES] → [YES] → [OK].



# Performing with a computer

## Handbook/software to be installed

### ■ “Handycam Handbook” (PDF)

“Handycam Handbook” (PDF) explains in detail about your camcorder and its practical use.

### ■ “Picture Motion Browser” (only for Windows users)

“Picture Motion Browser” is the supplied software. You can enjoy the following operations.

- Creating a disc with one touch operation
- Importing images to a computer
- Editing imported images
- Creating a disc

### 🔗 Notes

• The supplied software “Picture Motion Browser” is not supported by Macintosh computers. To use a Macintosh computer connected to your camcorder, see the following website for details.  
<http://guide.d-imaging.sony.co.jp/mac/ms/us/>

## Installing and viewing “Handycam Handbook” (PDF)

To view “Handycam Handbook” (PDF), you need to install Adobe Reader on your computer.

- ① Turn on the computer.
- ② Place the CD-ROM (supplied) in the disc drive of your computer.  
The select screen for installation appears.



- ③ Click [Handycam Handbook].  
The installation screen for “Handycam Handbook” (PDF) appears.

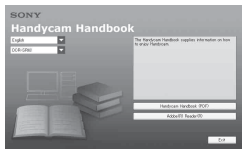

- ④ Select the desired language and the model name of your Handycam, then click [Handycam Handbook (PDF)].  
Installation starts. When the installation is completed, the short-cut icon of “Handycam Handbook” (PDF) appears on the desktop of your computer.
  - The model name of your Handycam is printed on its bottom surface.
- ⑤ Click [Exit] → [Exit], then remove the CD-ROM from the disc drive of your computer.  
To view “Handycam Handbook,” double-click the short-cut icon of “Handycam Handbook.”

### 💡 Tips

• For Macintosh users, follow the steps below.

- ① Turn on the computer.
- ② Place the CD-ROM (supplied) in the disc drive of your computer.
- ③ Open the [Handbook] folder in the CD-ROM, double-click the [GB] folder and then drag-and-drop the “Handbook.pdf” on the computer.  
To view “Handycam Handbook,” double-click “Handbook.pdf.”

## Installing “Picture Motion Browser”

### ■ System requirements

**OS:** Microsoft Windows 2000 Professional SP4/Windows XP SP2\*/Windows Vista\*

\* 64-bit editions and Starter (Edition) are not supported.

Standard installation is required. Operation is not assured if the above OS has been upgraded or in a multi-boot environment.

**CPU:** Intel Pentium 4 2.8 GHz or faster (Intel Pentium 4 3.6 GHz or faster, Intel Pentium D 2.8 GHz or faster, Intel Core Duo 1.66 GHz or faster, or Intel Core 2 Duo 1.66 GHz or faster is recommended.)

Intel Pentium III 1 GHz or faster enables the following operations:

- Importing the contents to the computer
- One Touch Disc Burn
- Creating an AVCHD format disc/DVD-video
- Copying a disc
- Processing only the contents in SD (standard definition) image quality

**Memory:** For Windows 2000/Windows XP: 512 MB or more (1 GB or more is recommended.)

For processing SD (standard definition) image quality content only, 256 MB of memory or more is necessary.

For Windows Vista: 1 GB or more

**Hard disk:** Disk volume required for installation: Approximately 500 MB (10 GB or more may be necessary when creating AVCHD format discs.)

**Display:** Minimum 1,024 × 768 dots

**Others:**  $\psi$  USB port (this must be provided as standard, Hi-Speed USB (USB 2.0 compatible) is recommended), DVD burner (CD-ROM drive is necessary for installation)

## Attention

This camcorder captures high definition footage in the AVCHD format. Using the enclosed PC software, high definition footage can be copied onto DVD media. However, DVD media containing AVCHD footage should not be used with DVD based players or recorders, as the DVD player/

recorder may fail to eject the media and may erase its contents without warning. DVD media containing AVCHD footage may be played on a compatible Blu-ray Disc™ player/recorder or other compatible device.

## ■ Installation procedure

You need to install the software to your Windows computer **before connecting your camcorder to the computer**. The installation is required only for the first time.

Contents to be installed and procedures may differ depending on your OS.

- ① Confirm that your camcorder is not connected to the computer.
- ② Turn on the computer.

## 🔗 Notes

- Log on as an Administrator for installation.
  - Close all applications running on the computer before installing the software.
- ③ Place the supplied CD-ROM in the disc drive of your computer.  
The installation screen appears.



## If the screen does not appear

- ① Click [Start], then click [My Computer]. (For Windows 2000, double-click [My Computer].)
- ② Double-click [SONYPICTUTIL (E:)] (CD-ROM) (disc drive).  
\* Drive names (such as (E:)) may vary depending on the computer.
- ④ Click [Install].
- ⑤ Select the language for the application to be installed, then click [Next].
- ⑥ As the screen to confirm the connection appears, connect your camcorder to the computer following the steps below.

- ❶ Connect the AC Adaptor to the Handycam Station and a wall outlet (wall socket).
- ❷ Set your camcorder onto the Handycam Station, then turn on your camcorder.
- ❸ Connect the  $\Psi$  (USB) jack of the Handycam Station (p. 17) to the computer using the supplied USB cable.  
The [USB SELECT] screen appears on your camcorder automatically.
- ❹ Touch  $\left[ \text{USB CONNECT} \right]$  or  $\left[ \text{USB CONNECT} \right]$  on the [USB SELECT] screen of your camcorder.



- ❺ Click [Continue].
- ❻ Read [License Agreement], select [I accept the terms of the license agreement] if you agree, then click [Next].
- ❼ Confirm the installation settings, then click [Install].
- ❽ Follow the on-screen instructions to install the software.  
Depending on the computer, you may need to install third party software. If the installation screen appears, follow the instructions to install the required software.
- ❾ Restart the computer if required to complete the installation.
- ❿ Remove the CD-ROM from the disc drive of your computer.

### To disconnect the USB cable

- ❶ Click the  $\left[ \text{Safely remove USB Mass Storage Device} \right]$  icon  $\rightarrow$  [Safely remove USB Mass Storage Device]  $\rightarrow$  [OK] (Windows 2000 only) on the task tray on the bottom right of the desktop of the computer.
- ❷ Touch [END]  $\rightarrow$  [YES] on the screen of your camcorder.
- ❸ Disconnect the USB cable.

### Operating the “Picture Motion Browser”

To start “Picture Motion Browser,” click [Start]  $\rightarrow$  [All Programs]  $\rightarrow$  [Sony Picture Utility]  $\rightarrow$  [PMB - Picture Motion Browser].

For the basic operation of “Picture Motion Browser,” see “PMB Guide.” To display “PMB Guide,” click [Start]  $\rightarrow$  [All Programs]  $\rightarrow$  [Sony Picture Utility]  $\rightarrow$  [Help]  $\rightarrow$  [PMB Guide].

#### Tips

- If the [USB SELECT] screen does not appear, touch  $\left[ \text{HOME} \right]$   $\rightarrow$   $\left[ \text{OTHERS} \right]$   $\rightarrow$  [USB CONNECT].

# Troubleshooting

If you run into any problems using your camcorder, use the following table to troubleshoot the problem. If the problem persists, disconnect the power source and contact your Sony dealer.

## Notes before sending your camcorder for repair

- Your camcorder may be required to initialize or change the current hard disk of the camcorder, depending on the problem. In the event of this, the data stored on the hard disk will be deleted. Be sure to save the data on the internal hard disk (see “Handycam Handbook” (PDF)) onto other media (backup) before sending your camcorder for repair. We will not compensate you for any loss of hard disk data.
- During repair, we may check a minimum amount of data stored on the hard disk in order to investigate the problem. However, your Sony dealer will neither copy nor retain your data.
- For the symptoms of your camcorder, see “Handycam Handbook” (PDF) and for connecting to the computer, see “PMB Guide.”

---

### The power does not turn on.

- Attach a charged battery pack to the camcorder (p. 8).
- Connect the plug of the AC Adaptor to the wall outlet (wall socket) (p. 8).

---

### The camcorder does not operate even when the power is set to on.

- It takes a few seconds for your camcorder to be ready to shoot after the power is turned on. This is not a malfunction.
- Disconnect the AC Adaptor from the wall outlet (wall socket) or remove the battery pack, then reconnect it after about 1 minute. If the functions still do not work, press the RESET button (p. 17) using a pointed object (If you press the RESET button, all settings, including the clock setting, are reset).

- The temperature of your camcorder is extremely high. Turn off your camcorder and leave it for a while in a cool place.
- The temperature of your camcorder is extremely low. Leave your camcorder with the power of your camcorder on. Turn off the camcorder and take it to a warm place. Leave the camcorder there for a while, then turn on the camcorder.

---

### Your camcorder gets warm.

- This is because the power has been turned on for a long time. This is not a malfunction.



---

### The power abruptly turns off.

- Use the AC Adaptor.
- Turn on the power again.
- Charge the battery pack (p. 8).

---

### Pressing START/STOP or PHOTO does not record images.

- Set the POWER switch to  (Movie) or  (Still) (p. 13).
- You cannot record images in sleep mode. Press the QUICK ON button (p. 16).
- Your camcorder is recording the image you have just shot on the media. You cannot make new recording during this period.
- The media is full. Delete unnecessary images (p. 24).
- Total number of movie scenes or still images exceeds the recordable capacity of the media. Delete unnecessary images (p. 24).

---

### The recording stops.

- The temperature of your camcorder is extremely high/low. Turn off your camcorder and leave it for a while in a cool/warm place.

---

### You cannot install “Picture Motion Browser.”

- Check the computer environment required to install “Picture Motion Browser.”
- Install “Picture Motion Browser” in the proper order (p. 26).

---

### “Picture Motion Browser” does not work correctly.

- Quit “Picture Motion Browser” and restart your computer.

---





### Your camcorder is not recognized by the computer.









- Disconnect devices from the USB jack of the computer other than the keyboard, mouse, and your camcorder.
- Disconnect the USB cable from the computer and the Handycam Station, and restart the computer, then connect the computer and your camcorder again in the proper order.

## Self-diagnosis display/Warning indicators

If indicators appear on the LCD screen or in the viewfinder, check the following.

If the problem persists even after you have tried to fix a couple of times, contact your Sony dealer or local authorized Sony service facility.

Indicators	Causes/Solutions
C:04:□□	<ul style="list-style-type: none"><li>• The battery pack is not an “InfoLITHIUM” battery pack (H series). Use an “InfoLITHIUM” battery pack (H series) (p. 8).</li><li>• Connect the DC plug of the AC Adaptor to the DC IN jack of the Handycam Station or your camcorder securely (p. 8).</li></ul>
C:13:□□ / C:32:□□	<ul style="list-style-type: none"><li>• Remove the power source. Reconnect it and operate your camcorder again.</li></ul>
E:20:□□ / E:31:□□ / E:61:□□ / E:62:□□ / E:91:□□ / E:94:□□	<ul style="list-style-type: none"><li>• A malfunction that you cannot service has occurred. Contact your Sony dealer or local authorized Sony service facility. Inform them of the 5-digit code, which starts from “E.”</li></ul>
101-0001	<ul style="list-style-type: none"><li>• When the indicator flashes slowly, the file is damaged or unreadable.</li></ul>
	<ul style="list-style-type: none"><li>• An error may have occurred with the hard disk drive in your camcorder.</li></ul>
	<ul style="list-style-type: none"><li>• The hard disk of the camcorder is full. Delete unnecessary images on the hard disk.</li><li>• An error may have occurred with the hard disk drive in your camcorder.</li></ul>
	<ul style="list-style-type: none"><li>• Battery power is low.</li></ul>
	<ul style="list-style-type: none"><li>• The temperature of your camcorder is getting high. Turn off your camcorder and</li></ul>

	<ul style="list-style-type: none"> <li>The temperature of your camcorder is low. Make the camcorder warm.</li> </ul>
	<ul style="list-style-type: none"> <li>When the indicator flashes slowly, free space for recording images are running out.</li> <li>No “Memory Stick PRO Duo” is inserted (p. 11).</li> <li>When the indicator flashes quickly, there are not enough free space for recording images.</li> <li>Delete unnecessary images, or format the “Memory Stick PRO Duo” after storing the images on other media (p. 23).</li> <li>The Image Database File is damaged.</li> </ul>
	<ul style="list-style-type: none"> <li>The “Memory Stick PRO Duo” is damaged. Format the “Memory Stick PRO Duo” with your camcorder.</li> </ul>
	<ul style="list-style-type: none"> <li>An incompatible “Memory Stick Duo” is inserted.</li> </ul>
	<ul style="list-style-type: none"> <li>Access to the “Memory Stick PRO Duo” was restricted on another device.</li> </ul>
	<ul style="list-style-type: none"> <li>There is something wrong with the flash.</li> </ul>
	<ul style="list-style-type: none"> <li>The amount of light is not sufficient. Use the flash.</li> <li>The camcorder is unsteady. Hold the camcorder steady with both hands. However, note that the camera-shake warning indicator does not disappear.</li> </ul>
	<ul style="list-style-type: none"> <li>The drop sensor function is activated. You may not record/play back images.</li> </ul>
	<ul style="list-style-type: none"> <li>The media is full.</li> <li>Still images cannot be recorded during processing. Wait for a while, then record.</li> </ul>

# Precautions

## On use and care

- Do not use or store the camcorder and accessories in the following locations:
  - Anywhere extremely hot, cold or humid. Never leave them exposed to temperatures above 60°C (140°F), such as under direct sunlight, near heaters or in a car parked in the sun. They may malfunction or become deformed.
  - Near strong magnetic fields or mechanical vibration. The camcorder may malfunction.
  - Near strong radio waves or radiation. The camcorder may not be able to record properly.
  - Near AM receivers and video equipment. Noise may occur.
  - On a sandy beach or anywhere dusty. If sand or dust gets in your camcorder, it may malfunction. Sometimes this malfunction cannot be repaired.
  - Near windows or outdoors, where the LCD screen, the viewfinder or the lens may be exposed to direct sunlight. This damages the inside of the LCD screen or the viewfinder.
- Operate your camcorder on DC 6.8 V/7.2 V (battery pack) or DC 8.4 V (AC Adaptor).
- For DC or AC operation, use the accessories recommended in these operating instructions.
- Do not let your camcorder get wet, for example, from rain or sea water. If your camcorder gets wet, it may malfunction. Sometimes this malfunction cannot be repaired.
- If any solid object or liquid gets inside the casing, unplug your camcorder and have it checked by a Sony dealer before operating it any further.
- Avoid rough handling, disassembling, modifying, physical shock, or impact such as hammering, dropping or stepping on the product. Be particularly careful of the lens.
- Keep the POWER switch setting to OFF (CHG) when you are not using your camcorder.
- Do not wrap your camcorder with a towel, for example, and operate it. Doing so might cause heat to build up inside.
- When disconnecting the power cord (mains lead), pull it by the plug and not the cord (lead).
- Do not damage the power cord (mains lead) such as by placing anything heavy on it.
- Keep metal contacts clean.

- Keep the Remote Commander and button-type battery out of children's reach. If the battery is accidentally swallowed, consult a doctor immediately.
- If the battery electrolytic liquid has leaked:
  - Consult your local authorized Sony service facility.
  - Wash off any liquid that may have contacted your skin.
  - If any liquid gets in your eyes, wash with plenty of water and consult a doctor.

## ■ When not using your camcorder for a long time

- Periodically turn it on and let it run such as by playing back or recording images for about 3 minutes.
- Use up the battery pack completely before storing it.

## LCD screen

- Do not exert excessive pressure on the LCD screen, as it may cause damage.
- If your camcorder is used in a cold place, a residual image may appear on the LCD screen. This is not a malfunction.
- While using your camcorder, the back of the LCD screen may heat up. This is not a malfunction.

## ■ To clean the LCD screen

If fingerprints or dust make the LCD screen dirty, it is recommended you use a soft cloth to clean it. When you use the LCD Cleaning Kit (optional), do not apply the cleaning liquid directly to the LCD screen. Use cleaning paper moistened with the liquid.

## On handling the casing

- If the casing is soiled, clean the camcorder body with a soft cloth lightly moistened with water, and then wipe the casing with a dry soft cloth.
- Avoid the following to avoid damage to the finish:
  - Using chemicals such as thinner, benzene, alcohol, chemical cloths, repellent, insecticide and sunscreen
  - Handling the camcorder with above substances

- Leaving the casing in contact with rubber or vinyl objects for a long period of time

## About care and storage of the lens

- Wipe the surface of the lens clean with a soft cloth in the following instances:
  - When there are fingerprints on the lens surface.
  - In hot or humid locations
  - When the lens is exposed to salty air such as at the seaside.
- Store in a well-ventilated location subject to little dirt or dust.
- To prevent mold, periodically clean the lens as described above. It is recommended that you operate your camcorder about once a month to keep it in optimum state for a long time.

## On charging the pre-installed rechargeable battery

Your camcorder has a pre-installed rechargeable battery to retain the date, time, and other settings even when the POWER switch is set to OFF (CHG). The pre-installed rechargeable battery is always charged while your camcorder is connected to the wall outlet (wall socket) via the AC Adaptor or while the battery pack is attached. The rechargeable battery will be fully discharged in **about 3 months** if you do not use your camcorder at all. Use your camcorder after charging the pre-installed rechargeable battery.

However, even if the pre-installed rechargeable battery is not charged, the camcorder operation will not be affected as long as you are not recording the date.

### ■ Procedures

Connect your camcorder to a wall outlet (wall socket) using the supplied AC Adaptor, and leave it with the POWER switch set to OFF (CHG) for more than 24 hours.

## To change the battery of the Remote Commander

- ① While pressing on the tab, inset your fingernail into the slit to pull out the battery case.
- ② Place a new battery with the + side facing up.
- ③ Insert the battery case back into the Remote Commander until it clicks.

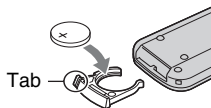

## WARNING

Battery may explode if mistreated. Do not recharge, disassemble or dispose of in fire.

- When the lithium battery becomes weak, the operating distance of the Remote Commander may shorten, or the Remote Commander may not function properly. In this case, replace the battery with a Sony CR2025 lithium battery. Use of another battery may present a risk of fire or explosion.



# Specifications

## System

Video compression format: AVCHD (HD)/  
MPEG2 (SD)/JPEG (Still images)

Audio compression format: Dolby Digital 2/5.1ch  
Dolby Digital 5.1 Creator

Video signal: PAL color, CCIR standards  
1080/50i specification

Hard disk: HDR-SR11E: 60 GB  
HDR-SR12E: 120 GB  
When measuring media capacity, 1 GB equals  
1 billion bytes, a portion of which is used for  
data management.

Recording format: Movie (HD): AVCHD 1080/  
50i  
Movie (SD): MPEG2-PS  
Still image: Exif Ver.2.2\*

Viewfinder: Electric viewfinder: color

Image device: 5.8 mm (1/3.13 type) CMOS sensor  
Recording pixels (still image, 4:3):  
Max. 10.2 mega (3 680 × 2 760) pixels\*\*  
Gross: Approx. 5 660 000 pixels  
Effective (movie, 16:9):  
Approx. 3 810 000 pixels  
Effective (still image, 16:9):  
Approx. 3 810 000 pixels  
Effective (still image, 4:3):  
Approx. 5 080 000 pixels

Lens: Carl Zeiss Vario-Sonnar T\*  
12 × (Optical), 24 ×, 150 × (Digital)

Focal length: F1.8 ~ 3.1  
Filter diameter: 37 mm (1 1/2 in.)  
f=4.9 ~ 58.8 mm (7/32 ~ 2 3/8 in.)  
When converted to a 35 mm still camera  
For movies: 40 ~ 480 mm (1 5/8 ~ 19 in.)  
(16:9)  
For still images: 37 ~ 444 mm (1 1/2 ~ 17 1/2  
in.) (4:3)

Color temperature: [AUTO], [ONE PUSH],  
[INDOOR] (3 200 K),  
[OUTDOOR] (5 800 K)

Minimum illumination: 5 lx (lux) ([AUTO SLW  
SHUTTR] [ON], Shutter speed 1/25 sec)  
0 lx (lux) (during NightShot function)

\* "Exif" is a file format for still images,  
established by the JEITA (Japan  
Electronics and Information Technology  
Industries Association). Files in this  
format can have additional information  
such as your camcorder's setting  
information at the time of recording.

\*\* The unique pixel array of Sony's ClearVid  
CMOS sensor and image processing  
system (BIONZ) allows for still image  
resolution equivalent to the sizes  
described.

## Input/Output connectors

A/V Remote Connector: Component/video and  
audio output jack

HDMI OUT jack: HDMI Type C mini connector

Headphone jack: Stereo minijack (Ø 3.5mm)

MIC input jack: Stereo minijack (Ø 3.5mm)

USB jack: mini-B

## LCD screen

Image: 8.0 cm (3.2 type, aspect ratio 16:9)

Total dot number: 921 600 (1 920 × 480)

## General

Power requirements: DC 6.8 V/7.2 V (battery  
pack)  
DC 8.4 V (AC Adaptor)

Average power consumption: During camera  
recording using the viewfinder with normal  
brightness:

Hard disk:

HD: 4.2 W SD: 3.6 W

"Memory Stick PRO Duo":

HD: 4.2 W SD: 3.5 W

During camera recording using the LCD with  
normal brightness:

Hard disk:

HD: 4.5 W SD: 3.8 W

"Memory Stick PRO Duo":

HD: 4.5 W SD: 3.8 W

Operating temperature: 0 °C to + 40 °C (32 °F to  
104 °F)

Storage temperature: -20 °C to + 60 °C (-4 °F to +  
140 °F)

Dimensions (approx.): 83 × 76 × 138 mm  
(3 3/8 × 3 × 5 1/2 in.) (w/h/d)  
including the projecting parts  
83 × 76 × 138 mm  
(3 3/8 × 3 × 5 1/2 in.) (w/h/d)  
including the projecting parts, and the supplied  
rechargeable battery pack attached

Mass (approx.): HDR-SR11E: 560 g (1 lb 3 oz)  
main unit only  
640 g (1 lb 6 oz) including the supplied  
rechargeable battery pack  
HDR-SR12E: 570 g (1 lb 4 oz) main unit only  
650 g (1 lb 6 oz) including the supplied  
rechargeable battery pack

## Handycam Station DCRA-C210

### Input/Output connectors

A/V OUT jack: Component/video and audio  
output jack

USB jack: mini-B

### AC Adaptor AC-L200/L200B

Power requirements: AC 100 V - 240 V, 50/60 Hz

Current consumption: 0.35 - 0.18 A

Power consumption: 18 W

Output voltage: DC 8.4 V\*

Operating temperature: 0 °C to + 40 °C (32 °F to  
104 °F)

Storage temperature: -20 °C to + 60 °C (-4 °F to +  
140 °F)

Dimensions (approx.): 48 × 29 × 81 mm  
(1 15/16 × 1 3/16 × 3 1/4 in.) (w/h/d)  
excluding the projecting parts

Mass (approx.): 170 g (6.0 oz) excluding the  
power cord (mains lead)

\* See the label on the AC Adaptor for other  
specifications.

### Rechargeable battery pack NP-FH60

Maximum output voltage: DC 8.4 V

Output voltage: DC 7.2 V

Capacity: 7.2 Wh (1 000 mAh)

Type: Li-ion

Design and specifications of your camcorder and  
accessories are subject to change without notice.

- Your camcorder is produced under the license of  
Dolby Laboratories.

## On trademarks

- “Handycam” and **HANDYCAM**  
are registered trademarks of Sony Corporation.
- “AVCHD” and “AVCHD” logotype are  
trademarks of Matsushita Electric Industrial  
Co., Ltd. and Sony Corporation.
- “Memory Stick,” “,” “Memory Stick  
Duo,” “**MEMORY STICK DUO**,” “Memory Stick  
PRO Duo,” “**MEMORY STICK PRO DUO**,”  
“Memory Stick PRO-HG Duo,”  
“**MEMORY STICK PRO-HG DUO**,” “MagicGate,”  
“**MAGICGATE**,” “MagicGate Memory  
Stick” and “MagicGate Memory Stick Duo” are  
trademarks or registered trademarks of Sony  
Corporation.
- “InfoLITHIUM” is a trademark of Sony  
Corporation.
- “x.v.Colour” is a trademark of Sony  
Corporation.
- “BIONZ” is a trademark of Sony Corporation.
- “BRAVIA” is a trademark of Sony Corporation.
- Dolby and the double-D symbol are trademarks  
of Dolby Laboratories.
- Dolby Digital 5.1 Creator is a trademark of  
Dolby Laboratories.
- HDMI, the HDMI logo and High-Definition  
Multimedia Interface are trademarks or  
registered trademarks of HDMI Licensing LLC.
- Microsoft, Windows, Windows Media,  
Windows Vista, and DirectX are either  
registered trademarks or trademarks of  
Microsoft Corporation in the United States and/  
or other countries.
- Macintosh and Mac OS are registered  
trademarks of Apple Inc. in the U.S. and other  
countries.
- Intel, Intel Core, and Pentium are trademarks or  
registered trademarks of Intel Corporation or its  
subsidiaries in the United States and other  
countries.
- Adobe, the Adobe logo, and Adobe Acrobat are  
either registered trademarks or trademarks of  
Adobe Systems Incorporated in the United  
States and/or other countries.

All other product names mentioned herein may be  
the trademarks or registered trademarks of their  
respective companies. Furthermore, <sup>TM</sup> and “®”  
are not mentioned in each case in this manual.

[www.DataSheet4U.com](http://www.DataSheet4U.com)

[www.DataSheet4U.com](http://www.DataSheet4U.com)

www.DataSheet4U.com

Additional information on this product and answers to frequently asked questions can be found at our Customer Support Website.

<http://www.sony.net/>



Printed on 70% or more recycled paper  
using VOC (Volatile Organic Compound)-  
free vegetable oil based ink.

Printed in Japan

[www.DataSheet4U.com](http://www.DataSheet4U.com)

3286586110