

### Features

- Glass Passivated Die Construction
- Diffused Junction
- Fast Switching for High Efficiency
- High Current Capability and Low Forward Voltage Drop
- Surge Overload Rating to 30A Peak
- Plastic Material: UL Flammability Classification Rating 94V-0

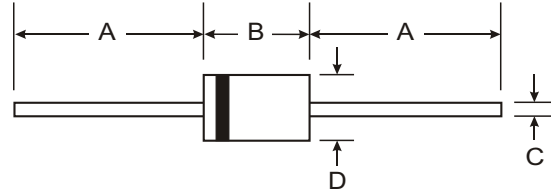

### Mechanical Data

- Case: Molded Plastic
- Terminals: Plated Leads Solderable per MIL-STD-202, Method 208
- Polarity: Cathode Band
- Marking: Type Number
- DO-41 Weight: 0.35 grams (approx.)
- A-405 Weight: 0.20 grams (approx.)

Dim	DO-41		A-405	
	Min	Max	Min	Max
A	25.40	—	25.40	—
B	4.06	5.21	4.10	5.20
C	0.71	0.864	0.53	0.64
D	2.00	2.72	2.00	2.70

All Dimensions in mm

“GL” Suffix Designates A-405 Package  
 “G” Suffix Designates DO-41 Package

### Maximum Ratings and Electrical Characteristics @ T<sub>A</sub> = 25°C unless otherwise specified

Single phase, half wave, 60Hz, resistive or inductive load.  
 For capacitive load, derate current by 20%.

Characteristic	Symbol	1N4933 G/GL	1N4934 G/GL	1N4935 G/GL	1N4936 G/GL	1N4937 G/GL	Unit
Peak Repetitive Reverse Voltage	V <sub>RRM</sub>	50	100	200	400	600	V
Working Peak Reverse Voltage	V <sub>RWM</sub>						
DC Blocking Voltage	V <sub>R</sub>						
RMS Reverse Voltage	V <sub>R(RMS)</sub>	35	70	140	280	420	V
Average Rectified Output Current (Note 1)	I <sub>O</sub>	1.0					A
		@ T <sub>A</sub> = 75°C					
Non-Repetitive Peak Forward Surge Current	I <sub>FSM</sub>	30					A
		8.3ms Single half sine-wave Superimposed on Rated Load (JEDEC Method)					
Forward Voltage	V <sub>FM</sub>	1.2					V
		@ I <sub>F</sub> = 1.0A					
Peak Reverse Current	I <sub>RM</sub>	5.0					μA
		@ T <sub>A</sub> = 25°C					
		@ T <sub>A</sub> = 100°C					
Reverse Recovery Time (Note 3)	t <sub>rr</sub>	200					ns
Typical Junction Capacitance (Note 2)	C <sub>j</sub>	15					pF
Typical Thermal Resistance Junction to Ambient	R <sub>θJA</sub>	100					K/W
Operating and Storage Temperature Range	T <sub>j</sub> , T <sub>STG</sub>	-65 to +150					°C

- Notes:
1. Valid provided that leads are maintained at ambient temperature at a distance of 9.5mm from the case.
  2. Measured at 1.0MHz and applied reverse voltage of 4.0V DC.
  3. Measured with I<sub>F</sub> 0.5A, I<sub>R</sub> = 1.0A, I<sub>rr</sub> = 0.25A.

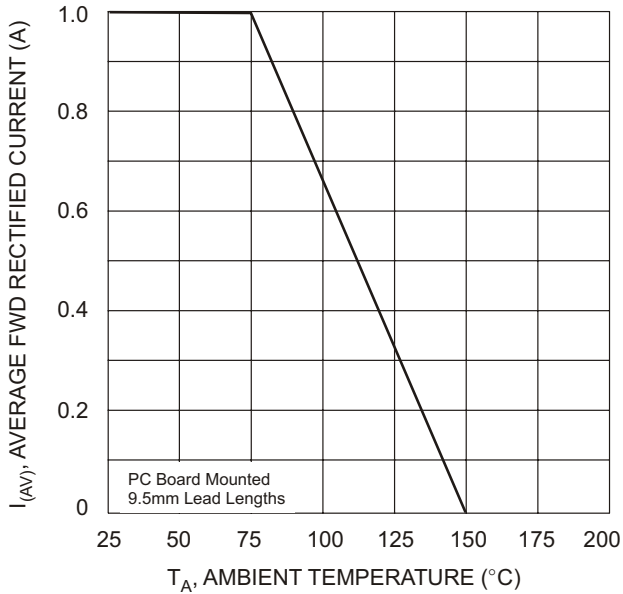

Fig. 1 Forward Current Derating Curves

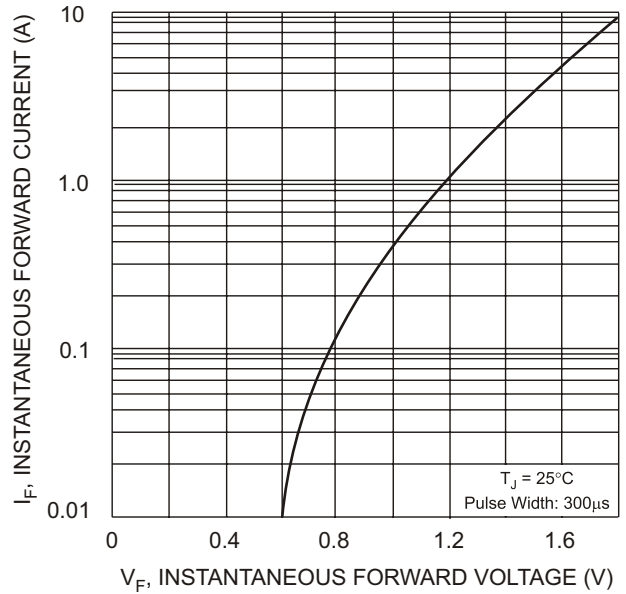

Fig. 2 Typical Forward Characteristics

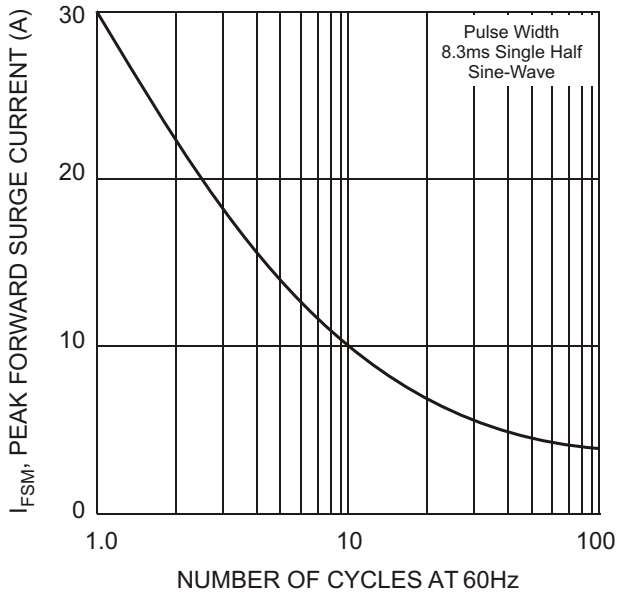

Fig. 3 Max Non-Repetitive Peak Fwd Surge Current

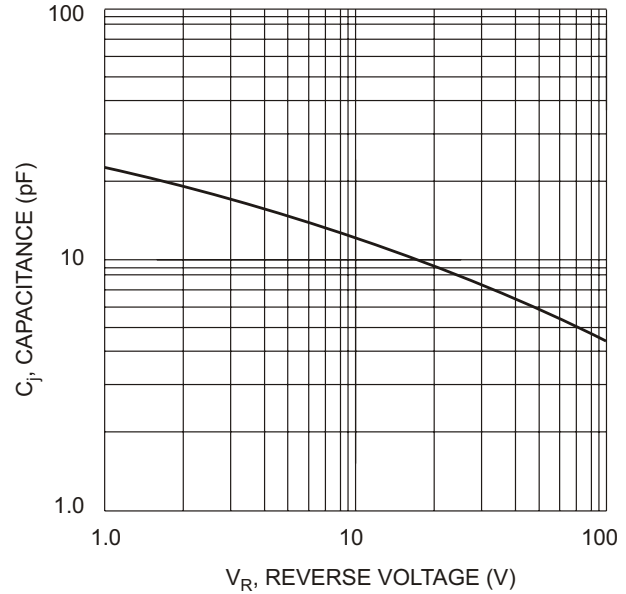
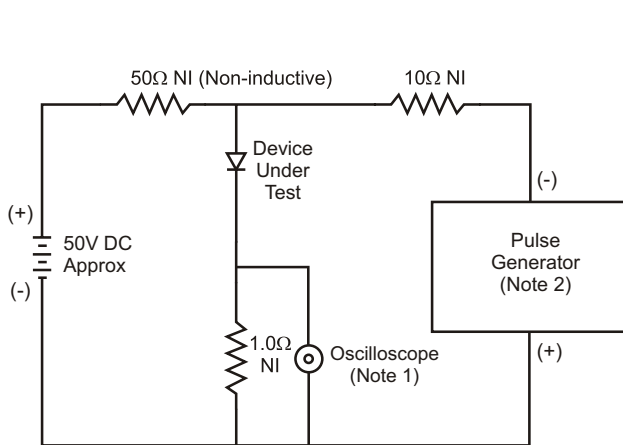
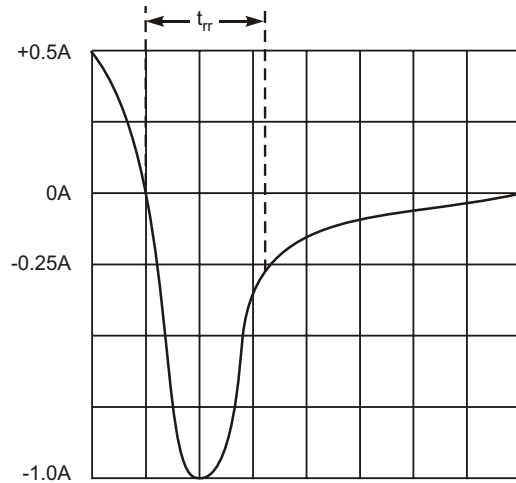

Fig. 4 Typical Junction Capacitance



- Notes:
1. Rise Time = 7.0ns max. Input Impedance = 1.0MΩ, 22pF.
  2. Rise Time = 10ns max. Input Impedance = 50Ω.



Set time base for 50/100 ns/cm

Fig. 5 Reverse Recovery Time Characteristic and Test Circuit