

# MC74HC1G14

## Single Inverter with Schmitt-Trigger Input

The MC74HC1G14 is a high speed CMOS inverter with Schmitt-Trigger input fabricated with silicon gate CMOS technology.

The internal circuit is composed of multiple stages, including a buffer output which provides high noise immunity and stable output.

The MC74HC1G14 output drive current is 1/2 compared to MC74HC series.

- High Speed:  $t_{PD} = 7 \text{ ns (Typ)}$  at  $V_{CC} = 5 \text{ V}$
- Low Power Dissipation:  $I_{CC} = 1 \mu\text{A (Max)}$  at  $T_A = 25^\circ\text{C}$
- High Noise Immunity
- Balanced Propagation Delays ( $t_{pLH} = t_{pHL}$ )
- Symmetrical Output Impedance ( $I_{OH} = I_{OL} = 2 \text{ mA}$ )
- Chip Complexity: FET = 101

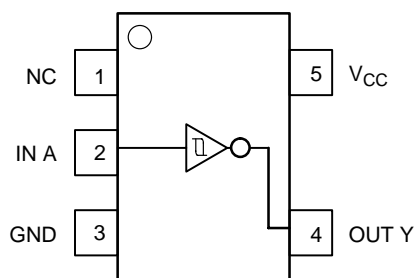

Figure 1. Pinout

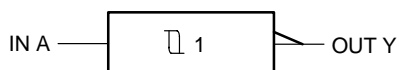
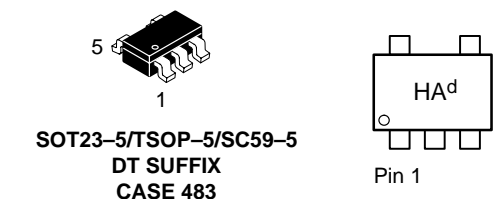
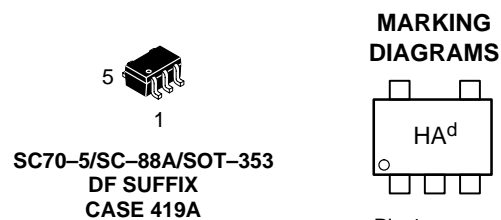

Figure 2. Logic Symbol



ON Semiconductor™

<http://onsemi.com>



d = Date Code

PIN ASSIGNMENT	
1	NC
2	IN A
3	GND
4	OUT Y
5	V <sub>CC</sub>

### FUNCTION TABLE

Inputs	Outputs
L	H
H	L

### ORDERING INFORMATION

See detailed ordering and shipping information in the package dimensions section on page 4 of this data sheet.

# MC74HC1G14

## MAXIMUM RATINGS

Symbol	Parameter	Value	Unit
V <sub>CC</sub>	DC Supply Voltage	-0.5 to +7.0	V
V <sub>IN</sub>	DC Input Voltage	-0.5 to V <sub>CC</sub> + 0.5	V
V <sub>OUT</sub>	DC Output Voltage	-0.5 to V <sub>CC</sub> + 0.5	V
I <sub>IK</sub>	DC Input Diode Current	±20	mA
I <sub>OK</sub>	DC Output Diode Current	±20	mA
I <sub>OUT</sub>	DC Output Sink Current	±12.5	mA
I <sub>CC</sub>	DC Supply Current per Supply Pin	±25	mA
T <sub>STG</sub>	Storage Temperature Range	-65 to +150	°C
T <sub>L</sub>	Lead Temperature, 1 mm from Case for 10 Seconds	260	°C
T <sub>J</sub>	Junction Temperature Under Bias	+150	°C
θ <sub>JA</sub>	Thermal Resistance	SC70-5/SC-88A/SOT-353 (Note 1) SOT23-5/TSOP-5/SC59-5 350 230	°C/W
P <sub>D</sub>	Power Dissipation in Still Air at 85°C	SC70-5/SC-88A/SOT-353 SOT23-5/TSOP-5/SC59-5 150 200	mW
MSL	Moisture Sensitivity	Level 1	
F <sub>R</sub>	Flammability Rating	Oxygen Index: 28 to 34 UL 94 V-0 @ 0.125 in	
V <sub>ESD</sub>	ESD Withstand Voltage	Human Body Model (Note 2) Machine Model (Note 3) Charged Device Model (Note 4) >2000 >200 N/A	V
I <sub>LATCH-UP</sub>	Latch-Up Performance	Above V <sub>CC</sub> and Below GND at 125°C (Note 5)	±500 mA

Maximum Ratings are those values beyond which damage to the device may occur. Exposure to these conditions or conditions beyond those indicated may adversely affect device reliability. Functional operation under absolute-maximum-rated conditions is not implied. Functional operation should be restricted to the Recommended Operating Conditions.

1. Measured with minimum pad spacing on an FR4 board, using 10 mm-by-1 inch, 20 ounce copper trace with no air flow.
2. Tested to EIA/JESD22-A114-A.
3. Tested to EIA/JESD22-A115-A.
4. Tested to JESD22-C101-A.
5. Tested to EIA/JESD78.

## RECOMMENDED OPERATING CONDITIONS

Symbol	Parameter	Min	Max	Unit	
V <sub>CC</sub>	DC Supply Voltage	2.0	6.0	V	
V <sub>IN</sub>	DC Input Voltage	0.0	V <sub>CC</sub>	V	
V <sub>OUT</sub>	DC Output Voltage	0.0	V <sub>CC</sub>	V	
T <sub>A</sub>	Operating Temperature Range	-55	+125	°C	
t <sub>r</sub> , t <sub>f</sub>	Input Rise and Fall Time	V <sub>CC</sub> = 2.0 V V <sub>CC</sub> = 3.0 V V <sub>CC</sub> = 4.5 V V <sub>CC</sub> = 6.0 V	0 0 0 0	1000 600 500 400	ns

## DEVICE JUNCTION TEMPERATURE VERSUS TIME TO 0.1% BOND FAILURES

Junction Temperature °C	Time, Hours	Time, Years
80	1,032,200	117.8
90	419,300	47.9
100	178,700	20.4
110	79,600	9.4
120	37,000	4.2
130	17,800	2.0
140	8,900	1.0

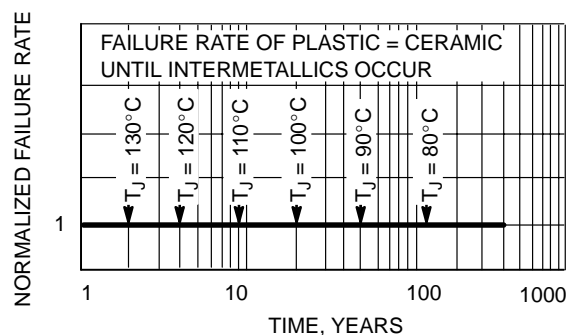

Figure 3. Failure Rate vs. Time Junction Temperature

# MC74HC1G14

## DC ELECTRICAL CHARACTERISTICS

Symbol	Parameter	Test Conditions	V <sub>CC</sub> (V)	T <sub>A</sub> = 25°C			T <sub>A</sub> ≤ 85°C		-55°C ≤ T <sub>A</sub> ≤ 125°C		Unit
				Min	Typ	Max	Min	Max	Min	Max	
V <sub>T+</sub>	Positive-Going Input Threshold Voltage	V <sub>OUT</sub> = 0.1 V  I <sub>OUT</sub>   ≤ 20 μA	2.0	1.00	1.34	1.50	0.95	1.60	0.90	1.60	V
			3.0	1.50	2.02	2.5	1.45	2.60	1.40	2.60	
			4.5	2.30	2.97	3.15	2.25	3.15	2.20	3.15	
			6.0	3.00	3.93	4.20	2.95	4.20	2.90	4.20	
V <sub>T-</sub>	Negative-Going Input Threshold Voltage	V <sub>OUT</sub> = V <sub>CC</sub> - 0.1 V  I <sub>OUT</sub>   ≤ 20 μA	2.0	0.55	0.86	1.15	0.55	1.20	0.55	1.25	V
			3.0	1.0	1.44	1.80	1.0	1.85	1.0	1.90	
			4.5	1.75	2.28	2.75	1.75	2.8	1.75	2.85	
			6.0	2.65	3.14	3.65	2.65	3.7	2.65	3.75	
V <sub>H</sub>	Hysteresis Voltage	V <sub>OUT</sub> = 0.1 V or V <sub>OUT</sub> = V <sub>CC</sub> - 0.1 V  I <sub>OUT</sub>   ≤ 20 μA	2.0	0.20	0.478	0.8	0.20	0.8	0.20	0.8	V
			3.0	0.25	0.584	0.95	0.25	0.55	0.25	0.95	
			4.5	0.30	0.686	1.1	0.30	1.1	0.30	1.1	
			6.0	0.40	0.790	1.25	0.40	1.5	0.40	1.25	
V <sub>OH</sub>	Minimum High-Level Output Voltage	V <sub>IN</sub> = V <sub>IH</sub> or V <sub>IL</sub> I <sub>OH</sub> = -20 μA	2.0	1.9	2.0		1.9		1.9	V	
			3.0	2.9	3.0		2.9		2.9		
			4.5	4.4	4.5		4.4		4.4		
			6.0	5.9	6.0		5.9		5.9		
V <sub>OL</sub>	Maximum Low-Level Output Voltage	V <sub>IN</sub> ≥ V <sub>T+</sub> + Max I <sub>OL</sub> = 20 μA	2.0		0.0	0.1		0.1		0.1	V
			3.0		0.0	0.1		0.1		0.1	
			4.5		0.0	0.1		0.1		0.1	
			6.0		0.0	0.1		0.1		0.1	
V <sub>OL</sub>	Maximum Low-Level Output Voltage	V <sub>IN</sub> = V <sub>IH</sub> or V <sub>IL</sub> I <sub>OL</sub> = 2 mA I <sub>OL</sub> = 2.6 mA	4.5		0.17	0.26		0.33		0.40	V
			6.0		0.18	0.26		0.33		0.40	
I <sub>IN</sub>	Maximum Input Leakage Current	V <sub>IN</sub> = 6.0 V or GND	6.0			±0.1		±1.0		±1.0	μA
I <sub>CC</sub>	Maximum Quiescent Supply Current	V <sub>IN</sub> = V <sub>CC</sub> or GND	6.0			1.0		10		40	μA

## AC ELECTRICAL CHARACTERISTICS (Input t<sub>r</sub> = t<sub>f</sub> = 6.0 ns)

Symbol	Parameter	Test Conditions	T <sub>A</sub> = 25°C			T <sub>A</sub> ≤ 85°C		-55°C ≤ T <sub>A</sub> ≤ 125°C		Unit	
			Min	Typ	Max	Min	Max	Min	Max		
t <sub>PLH</sub> , t <sub>PHL</sub>	Maximum Propagation Delay, Input A or B to Y	V <sub>CC</sub> = 5.0 V C <sub>L</sub> = 15 pF		3.5	15		20		25	ns	
			V <sub>CC</sub> = 2.0 V C <sub>L</sub> = 50 pF		19	100		125			155
				V <sub>CC</sub> = 3.0 V	10.5	27		35			90
				V <sub>CC</sub> = 4.5 V	7.5	20		25			35
				V <sub>CC</sub> = 6.0 V	6.5	17		21			26
t <sub>TLH</sub> , t <sub>THL</sub>	Output Transition Time	V <sub>CC</sub> = 5.0 V C <sub>L</sub> = 15 pF		3	10		15		20	ns	
			V <sub>CC</sub> = 2.0 V C <sub>L</sub> = 50 pF		25	125		155			200
				V <sub>CC</sub> = 3.0 V	16	35		45			60
				V <sub>CC</sub> = 4.5 V	11	25		31			38
				V <sub>CC</sub> = 6.0 V	9	21		26			32
C <sub>IN</sub>	Maximum Input Capacitance		5	10		10		10	pF		
C <sub>PD</sub>	Power Dissipation Capacitance (Note 6)	Typical @ 25°C, V <sub>CC</sub> = 5.0 V							pF		
		10									

6. C<sub>PD</sub> is defined as the value of the internal equivalent capacitance which is calculated from the operating current consumption without load. Average operating current can be obtained by the equation: I<sub>CC(OPR)</sub> = C<sub>PD</sub> • V<sub>CC</sub> • f<sub>in</sub> + I<sub>CC</sub>. C<sub>PD</sub> is used to determine the no-load dynamic power consumption; P<sub>D</sub> = C<sub>PD</sub> • V<sub>CC</sub><sup>2</sup> • f<sub>in</sub> + I<sub>CC</sub> • V<sub>CC</sub>.

# MC74HC1G14

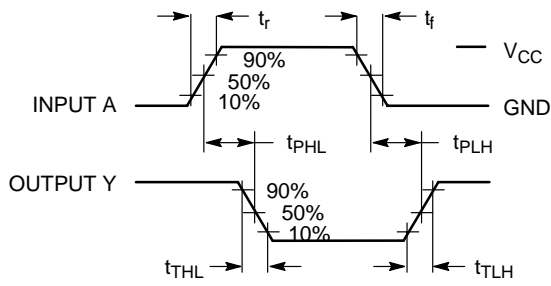
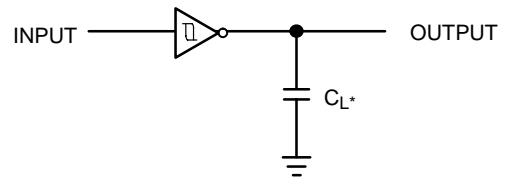

Figure 4. Switching Waveforms



\*Includes all probe and jig capacitance.  
A 1-MHz square input wave is recommended for propagation delay tests.

Figure 5. Test Circuit

## DEVICE ORDERING INFORMATION

Device Order Number	Device Nomenclature						Package Type (Name/SOT#/Common Name)	Tape and Reel Size
	Logic Circuit Indicator	Temp Range Identifier	Technology	Device Function	Package Suffix	Tape and Reel Suffix		
MC74HC1G14DFT1	MC	74	HC1G	14	DF	T1	SC70-5/SC-88A/SOT-353	178 mm (7 in) 3000 Unit
MC74HC1G14DFT2	MC	74	HC1G	14	DF	T2	SC70-5/SC-88A/SOT-353	178 mm (7 in) 3000 Unit
MC74HC1G14DTT1	MC	74	HC1G	14	DT	T1	SOT23-5/TSOP-5/SC59-5	178 mm (7 in) 3000 Unit

# MC74HC1G14

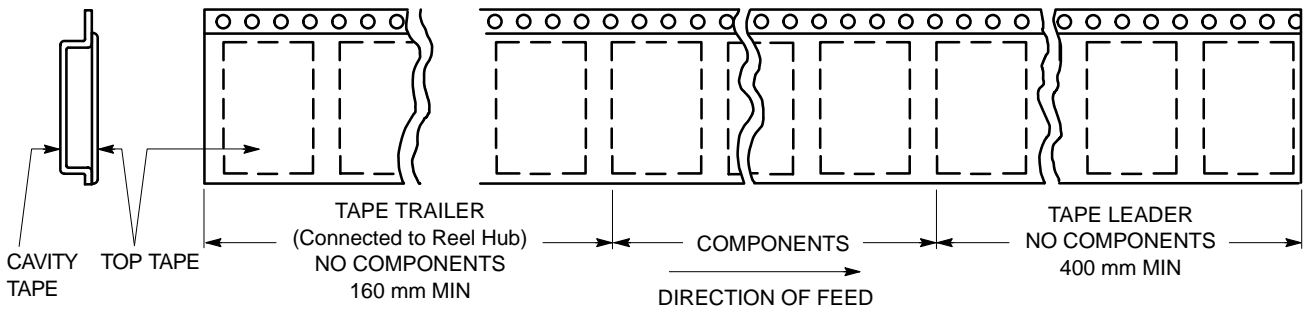

**Figure 6. Tape Ends for Finished Goods**

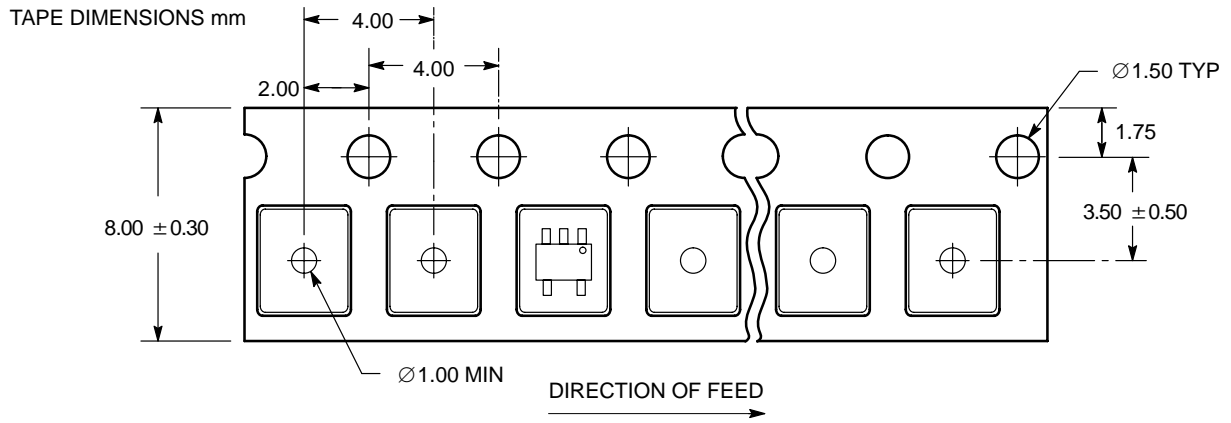

**Figure 7. DFT1 Reel Configuration/Orientation**

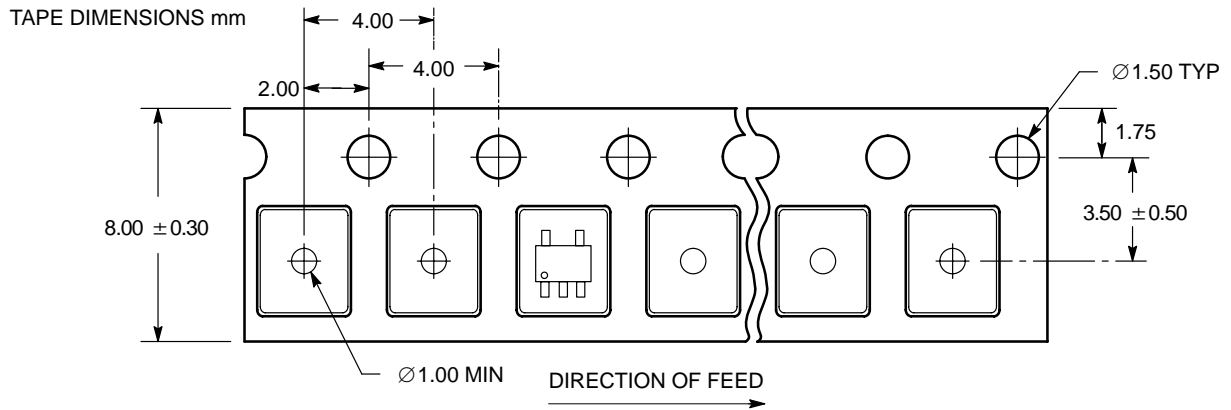

**Figure 8. DFT2/DTT1 Reel Configuration/Orientation**

# MC74HC1G14

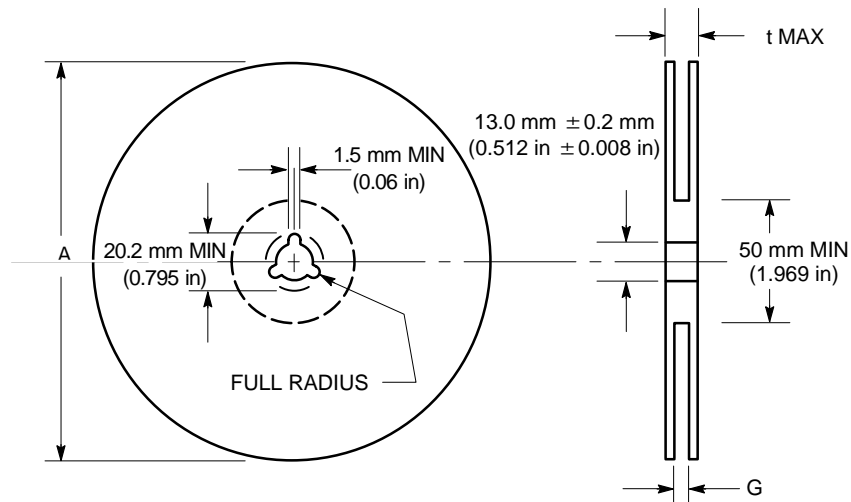

Figure 9. Reel Dimensions

## REEL DIMENSIONS

Tape Size	T and R Suffix	A Max	G	t Max
8 mm	T1, T2	178 mm (7 in)	8.4 mm, +1.5 mm, -0.0 (0.33 in +0.059 in, -0.00)	14.4 mm (0.56 in)

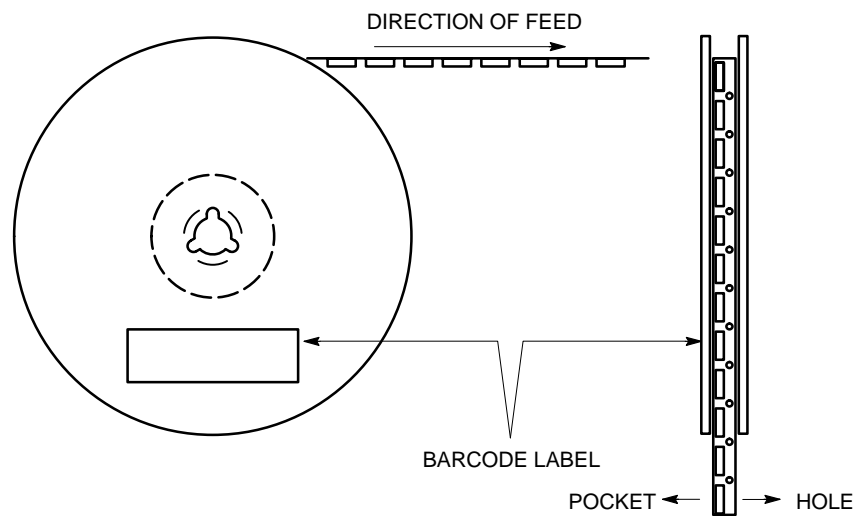
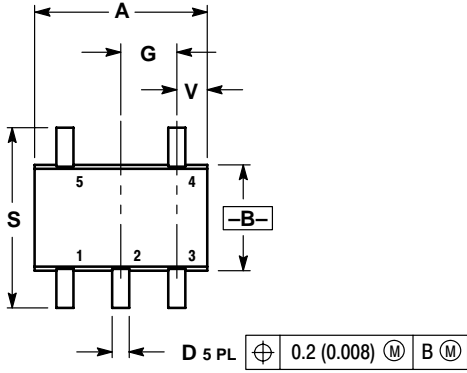

Figure 10. Reel Winding Direction

# MC74HC1G14

## PACKAGE DIMENSIONS

SC70-5/SC-88A/SOT-353  
 DF SUFFIX  
 5-LEAD PACKAGE  
 CASE 419A-01  
 ISSUE E



- NOTES:  
 1. DIMENSIONING AND TOLERANCING PER ANSI Y14.5M, 1982.  
 2. CONTROLLING DIMENSION: INCH.

DIM	INCHES		MILLIMETERS	
	MIN	MAX	MIN	MAX
A	0.071	0.087	1.80	2.20
B	0.045	0.053	1.15	1.35
C	0.031	0.043	0.80	1.10
D	0.004	0.012	0.10	0.30
G	0.026 BSC		0.65 BSC	
H	---	0.004	---	0.10
J	0.004	0.010	0.10	0.25
K	0.004	0.012	0.10	0.30
N	0.008 REF		0.20 REF	
S	0.079	0.087	2.00	2.20
V	0.012	0.016	0.30	0.40

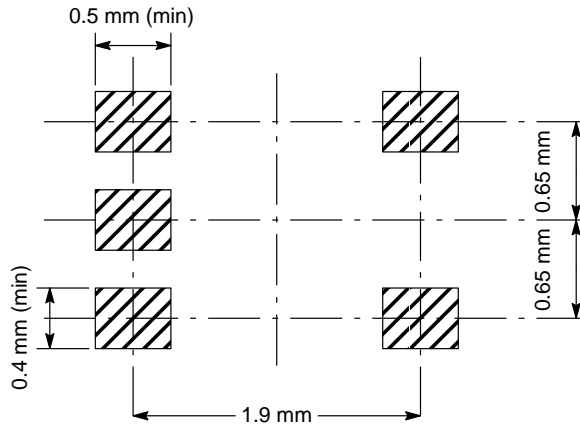
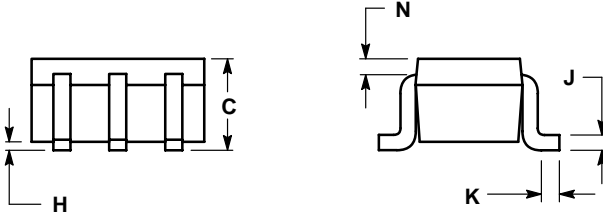

# MC74HC1G14

## PACKAGE DIMENSIONS

SOT23-5/TSOP-5/SC59-5  
DT SUFFIX  
5-LEAD PACKAGE  
CASE 483-01  
ISSUE B

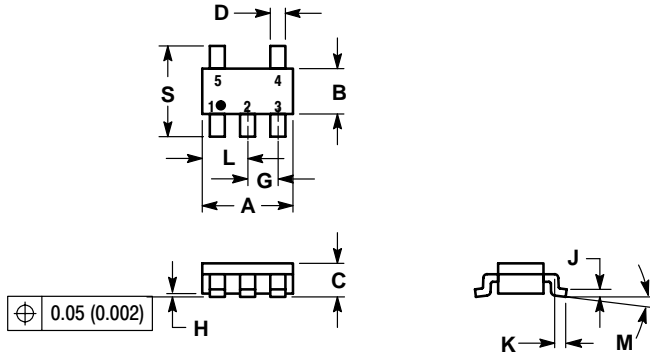

NOTES:

1. DIMENSIONING AND TOLERANCING PER ANSI Y14.5M, 1982.
2. CONTROLLING DIMENSION: MILLIMETER.
3. MAXIMUM LEAD THICKNESS INCLUDES LEAD FINISH THICKNESS. MINIMUM LEAD THICKNESS IS THE MINIMUM THICKNESS OF BASE MATERIAL.

DIM	MILLIMETERS		INCHES	
	MIN	MAX	MIN	MAX
A	2.90	3.10	0.1142	0.1220
B	1.30	1.70	0.0512	0.0669
C	0.90	1.10	0.0354	0.0433
D	0.25	0.50	0.0098	0.0197
G	0.85	1.05	0.0335	0.0413
H	0.013	0.100	0.0005	0.0040
J	0.10	0.26	0.0040	0.0102
K	0.20	0.60	0.0079	0.0236
L	1.25	1.55	0.0493	0.0610
M	0°	10°	0°	10°
S	2.50	3.00	0.0985	0.1181

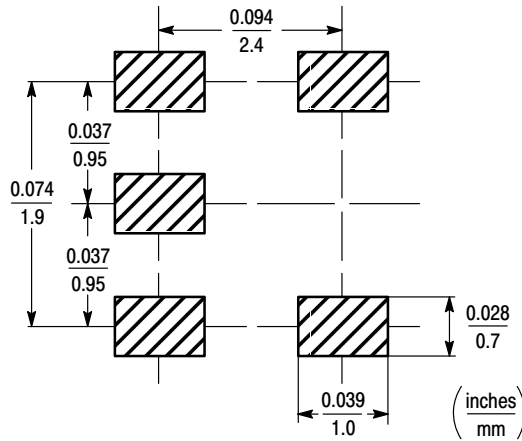

**ON Semiconductor** and  are trademarks of Semiconductor Components Industries, LLC (SCILLC). SCILLC reserves the right to make changes without further notice to any products herein. SCILLC makes no warranty, representation or guarantee regarding the suitability of its products for any particular purpose, nor does SCILLC assume any liability arising out of the application or use of any product or circuit, and specifically disclaims any and all liability, including without limitation special, consequential or incidental damages. "Typical" parameters which may be provided in SCILLC data sheets and/or specifications can and do vary in different applications and actual performance may vary over time. All operating parameters, including "Typicals" must be validated for each customer application by customer's technical experts. SCILLC does not convey any license under its patent rights nor the rights of others. SCILLC products are not designed, intended, or authorized for use as components in systems intended for surgical implant into the body, or other applications intended to support or sustain life, or for any other application in which the failure of the SCILLC product could create a situation where personal injury or death may occur. Should Buyer purchase or use SCILLC products for any such unintended or unauthorized application, Buyer shall indemnify and hold SCILLC and its officers, employees, subsidiaries, affiliates, and distributors harmless against all claims, costs, damages, and expenses, and reasonable attorney fees arising out of, directly or indirectly, any claim of personal injury or death associated with such unintended or unauthorized use, even if such claim alleges that SCILLC was negligent regarding the design or manufacture of the part. SCILLC is an Equal Opportunity/Affirmative Action Employer.

### PUBLICATION ORDERING INFORMATION

**Literature Fulfillment:**

Literature Distribution Center for ON Semiconductor  
P.O. Box 5163, Denver, Colorado 80217 USA  
**Phone:** 303-675-2175 or 800-344-3860 Toll Free USA/Canada  
**Fax:** 303-675-2176 or 800-344-3867 Toll Free USA/Canada  
**Email:** ONlit@hibbertco.com

**N. American Technical Support:** 800-282-9855 Toll Free USA/Canada

**JAPAN:** ON Semiconductor, Japan Customer Focus Center  
4-32-1 Nishi-Gotanda, Shinagawa-ku, Tokyo, Japan 141-0031  
**Phone:** 81-3-5740-2700  
**Email:** r14525@onsemi.com

**ON Semiconductor Website:** <http://onsemi.com>

For additional information, please contact your local Sales Representative.