

MOS INTEGRATED CIRCUIT

μ PD44165084, 44165184, 44165364

18M-BIT QDR™II SRAM

4-WORD BURST OPERATION

Description

The μ PD44165084 is a 2,097,152-word by 8-bit, the μ PD44165184 is a 1,048,576-word by 18-bit and the μ PD44165364 is a 524,288-word by 36-bit synchronous quad data rate static RAM fabricated with advanced CMOS technology using full CMOS six-transistor memory cell.

The μ PD44165084, μ PD44165184 and μ PD44165364 integrates unique synchronous peripheral circuitry and a burst counter. All input registers controlled by an input clock pair (K and /K) are latched on the positive edge of K and /K.

These products are suitable for application which require synchronous operation, high speed, low voltage, high density and wide bit configuration.

These products are packaged in 165-pin PLASTIC BGA.

Features

- 1.8 ± 0.1 V power supply and HSTL I/O
- DLL circuitry for wide output data valid window and future frequency scaling
- Separate independent read and write data ports with concurrent transactions
- 100% bus utilization DDR READ and WRITE operation
- Four-tick burst for reduced address frequency
- Two input clocks (K and /K) for precise DDR timing at clock rising edges only
- Two output clocks (C and /C) for precise flight time
and clock skew matching-clock and data delivered together to receiving device
- Internally self-timed write control
- Clock-stop capability with μ s restart
- User programmable impedance output
- Fast clock cycle time : 4.0 ns (250 MHz) , 5.0 ns (200 MHz) , 6.0 ns (167 MHz)
- Simple control logic for easy depth expansion
- JTAG boundary scan

The information in this document is subject to change without notice. Before using this document, please confirm that this is the latest version.
Not all products and/or types are available in every country. Please check with an NEC Electronics sales representative for availability and additional information.

★ Ordering Information

Part number	Cycle Time ns	Clock Frequency MHz	Organization (word x bit)	Core Supply Voltage V	I/O Interface	Package
μPD44165084F5-E40-EQ1	4.0	250	2 M x 8-bit	1.8 ± 0.1	HSTL	165-pin PLASTIC BGA (13 x 15)
μPD44165084F5-E50-EQ1	5.0	200				
μPD44165084F5-E60-EQ1	6.0	167				
μPD44165184F5-E40-EQ1	4.0	250	1 M x 18-bit			
μPD44165184F5-E50-EQ1	5.0	200				
μPD44165184F5-E60-EQ1	6.0	167				
μPD44165364F5-E50-EQ1	5.0	200	512 K x 36-bit			
μPD44165364F5-E60-EQ1	6.0	167				

Pin Configurations

/xxx indicates active low signal.

165-pin PLASTIC BGA (13 x 15)

(Top View)

[μPD44165084F5-EQ1]

	1	2	3	4	5	6	7	8	9	10	11
A	/CQ	V _{SS}	A	/W	/NW1	/K	NC	/R	A	V _{SS}	CQ
B	NC	NC	NC	A	NC	K	/NW0	A	NC	NC	Q3
C	NC	NC	NC	V _{SS}	A	NC	A	V _{SS}	NC	NC	D3
D	NC	D4	NC	V _{SS}	V _{SS}	V _{SS}	V _{SS}	V _{SS}	NC	NC	NC
E	NC	NC	Q4	V _{DDQ}	V _{SS}	V _{SS}	V _{SS}	V _{DDQ}	NC	D2	Q2
F	NC	NC	NC	V _{DDQ}	V _{DD}	V _{SS}	V _{DD}	V _{DDQ}	NC	NC	NC
G	NC	D5	Q5	V _{DDQ}	V _{DD}	V _{SS}	V _{DD}	V _{DDQ}	NC	NC	NC
H	/DLL	V _{REF}	V _{DDQ}	V _{DDQ}	V _{DD}	V _{SS}	V _{DD}	V _{DDQ}	V _{DDQ}	V _{REF}	ZQ
J	NC	NC	NC	V _{DDQ}	V _{DD}	V _{SS}	V _{DD}	V _{DDQ}	NC	Q1	D1
K	NC	NC	NC	V _{DDQ}	V _{DD}	V _{SS}	V _{DD}	V _{DDQ}	NC	NC	NC
L	NC	Q6	D6	V _{DDQ}	V _{SS}	V _{SS}	V _{SS}	V _{DDQ}	NC	NC	Q0
M	NC	NC	NC	V _{SS}	V _{SS}	V _{SS}	V _{SS}	V _{SS}	NC	NC	D0
N	NC	D7	NC	V _{SS}	A	A	A	V _{SS}	NC	NC	NC
P	NC	NC	Q7	A	A	C	A	A	NC	NC	NC
R	TDO	TCK	A	A	A	/C	A	A	A	TMS	TDI

- A : Address inputs
- D0 to D7 : Data inputs
- Q0 to Q7 : Data outputs
- /R : Read input
- /W : Write input
- /NW0, /NW1 : Nibble Write data select
- K, /K : Input clock
- C, /C : Output clock
- CQ, /CQ : Echo clock
- ZQ : Output impedance matching
- /DLL : DLL disable
- TMS : IEEE 1149.1 Test input
- TDI : IEEE 1149.1 Test input
- TCK : IEEE 1149.1 Clock input
- TDO : IEEE 1149.1 Test output
- V_{REF} : HSTL input reference input
- V_{DD} : Power Supply
- V_{DDQ} : Power Supply
- V_{SS} : Ground
- NC : No connection

Remark Refer to **Package Drawing** for the index mark.

165-pin PLASTIC BGA (13 x 15)
 (Top View)
 [μPD44165184F5-EQ1]

	1	2	3	4	5	6	7	8	9	10	11
A	/CQ	V _{SS}	NC	/W	/BW1	/K	NC	/R	A	V _{SS}	CQ
B	NC	Q9	D9	A	NC	K	/BW0	A	NC	NC	Q8
C	NC	NC	D10	V _{SS}	A	NC	A	V _{SS}	NC	Q7	D8
D	NC	D11	Q10	V _{SS}	V _{SS}	V _{SS}	V _{SS}	V _{SS}	NC	NC	D7
E	NC	NC	Q11	V _{DDQ}	V _{SS}	V _{SS}	V _{SS}	V _{DDQ}	NC	D6	Q6
F	NC	Q12	D12	V _{DDQ}	V _{DD}	V _{SS}	V _{DD}	V _{DDQ}	NC	NC	Q5
G	NC	D13	Q13	V _{DDQ}	V _{DD}	V _{SS}	V _{DD}	V _{DDQ}	NC	NC	D5
H	/DLL	V _{REF}	V _{DDQ}	V _{DDQ}	V _{DD}	V _{SS}	V _{DD}	V _{DDQ}	V _{DDQ}	V _{REF}	ZQ
J	NC	NC	D14	V _{DDQ}	V _{DD}	V _{SS}	V _{DD}	V _{DDQ}	NC	Q4	D4
K	NC	NC	Q14	V _{DDQ}	V _{DD}	V _{SS}	V _{DD}	V _{DDQ}	NC	D3	Q3
L	NC	Q15	D15	V _{DDQ}	V _{SS}	V _{SS}	V _{SS}	V _{DDQ}	NC	NC	Q2
M	NC	NC	D16	V _{SS}	V _{SS}	V _{SS}	V _{SS}	V _{SS}	NC	Q1	D2
N	NC	D17	Q16	V _{SS}	A	A	A	V _{SS}	NC	NC	D1
P	NC	NC	Q17	A	A	C	A	A	NC	D0	Q0
R	TDO	TCK	A	A	A	/C	A	A	A	TMS	TDI

- | | | | |
|------------|-----------------------------|------------------|------------------------------|
| A | : Address inputs | TMS | : IEEE 1149.1 Test input |
| D0 to D17 | : Data inputs | TDI | : IEEE 1149.1 Test input |
| Q0 to Q17 | : Data outputs | TCK | : IEEE 1149.1 Clock input |
| /R | : Read input | TDO | : IEEE 1149.1 Test output |
| /W | : Write input | V _{REF} | : HSTL input reference input |
| /BW0, /BW1 | : Byte Write data select | V _{DD} | : Power Supply |
| K, /K | : Input clock | V _{DDQ} | : Power Supply |
| C, /C | : Output clock | V _{SS} | : Ground |
| CQ, /CQ | : Echo clock | NC | : No connection |
| ZQ | : Output impedance matching | | |
| /DLL | : DLL disable | | |

Remark Refer to **Package Drawing** for the index mark.

165-pin PLASTIC BGA (13 x 15)
 (Top View)
 [μPD44165364F5-EQ1]

	1	2	3	4	5	6	7	8	9	10	11
A	/CQ	V _{SS}	NC	/W	/BW2	/K	/BW1	/R	NC	V _{SS}	CQ
B	Q27	Q18	D18	A	/BW3	K	/BW0	A	D17	Q17	Q8
C	D27	Q28	D19	V _{SS}	A	NC	A	V _{SS}	D16	Q7	D8
D	D28	D20	Q19	V _{SS}	V _{SS}	V _{SS}	V _{SS}	V _{SS}	Q16	D15	D7
E	Q29	D29	Q20	V _{DDQ}	V _{SS}	V _{SS}	V _{SS}	V _{DDQ}	Q15	D6	Q6
F	Q30	Q21	D21	V _{DDQ}	V _{DD}	V _{SS}	V _{DD}	V _{DDQ}	D14	Q14	Q5
G	D30	D22	Q22	V _{DDQ}	V _{DD}	V _{SS}	V _{DD}	V _{DDQ}	Q13	D13	D5
H	/DLL	V _{REF}	V _{DDQ}	V _{DDQ}	V _{DD}	V _{SS}	V _{DD}	V _{DDQ}	V _{DDQ}	V _{REF}	ZQ
J	D31	Q31	D23	V _{DDQ}	V _{DD}	V _{SS}	V _{DD}	V _{DDQ}	D12	Q4	D4
K	Q32	D32	Q23	V _{DDQ}	V _{DD}	V _{SS}	V _{DD}	V _{DDQ}	Q12	D3	Q3
L	Q33	Q24	D24	V _{DDQ}	V _{SS}	V _{SS}	V _{SS}	V _{DDQ}	D11	Q11	Q2
M	D33	Q34	D25	V _{SS}	V _{SS}	V _{SS}	V _{SS}	V _{SS}	D10	Q1	D2
N	D34	D26	Q25	V _{SS}	A	A	A	V _{SS}	Q10	D9	D1
P	Q35	D35	Q26	A	A	C	A	A	Q9	D0	Q0
R	TDO	TCK	A	A	A	/C	A	A	A	TMS	TDI

- | | | | |
|--------------|-----------------------------|------------------|------------------------------|
| A | : Address inputs | TMS | : IEEE 1149.1 Test input |
| D0 to D35 | : Data inputs | TDI | : IEEE 1149.1 Test input |
| Q0 to Q35 | : Data outputs | TCK | : IEEE 1149.1 Clock input |
| /R | : Read input | TDO | : IEEE 1149.1 Test output |
| /W | : Write input | V _{REF} | : HSTL input reference input |
| /BW0 to /BW3 | : Byte Write data select | V _{DD} | : Power Supply |
| K, /K | : Input clock | V _{DDQ} | : Power Supply |
| C, /C | : Output clock | V _{SS} | : Ground |
| CQ, /CQ | : Echo clock | NC | : No connection |
| ZQ | : Output impedance matching | | |
| /DLL | : DLL disable | | |

Remark Refer to **Package Drawing** for the index mark.

Pin Identification

Symbol	Description
A	Synchronous Address Inputs: These inputs are registered and must meet the setup and hold times around the rising edge of K. Balls 9A, 3A, 10A, and 2A are reserved for the next higher-order address inputs on future devices. All transactions operate on a burst of four words (two clock periods of bus activity). These inputs are ignored when device is deselected.
D0 to Dxx	Synchronous Data Inputs: Input data must meet setup and hold times around the rising edges of K and /K during WRITE operations. See Pin Configurations for ball site location of individual signals. x8 device uses D0 to D7. x18 device uses D0 to D17. x36 device uses D0 to D35.
Q0 to Qxx	Synchronous Data Outputs: Output data is synchronized to the respective C and /C or to K and /K rising edges if C and /C are tied HIGH. This bus operates in response to /R commands. See Pin Configurations for ball site location of individual signals. x8 device uses Q0 to Q7. x18 device uses Q0 to Q17. x36 device uses Q0 to Q35.
/R	Synchronous Read: When LOW this input causes the address inputs to be registered and a READ cycle to be initiated. This input must meet setup and hold times around the rising edge of K and is ignored on the subsequent rising edge of K.
/W	Synchronous Write: When LOW this input causes the address inputs to be registered and a WRITE cycle to be initiated. This input must meet setup and hold times around the rising edge of K and is ignored on the subsequent rising edge of K.
/BWx /NWx	Synchronous Byte Writes (Nibble Writes on x8): When LOW these inputs cause their respective byte or nibble to be registered and written during WRITE cycles. These signals must meet setup and hold times around the rising edges of K and /K for each of the two rising edges comprising the WRITE cycle. See Pin Configurations for signal to data relationships.
K, /K	Input Clock: This input clock pair registers address and control inputs on the rising edge of K, and registers data on the rising edge of K and the rising edge of /K. /K is ideally 180 degrees out of phase with K. All synchronous inputs must meet setup and hold times around the clock rising edges.
C, /C	Output Clock: This clock pair provides a user controlled means of tuning device output data. The rising edge of /C is used as the output timing reference for first and third output data. The rising edge of C is used as the output reference for second and fourth output data. Ideally, /C is 180 degrees out of phase with C. C and /C may be tied HIGH to force the use of K and /K as the output reference clocks instead of having to provide C and /C clocks. If tied HIGH, C and /C must remain HIGH and not be toggled during device operation.
CQ, /CQ	Synchronous Echo Clock Outputs. The rising edges of these outputs are tightly matched to the synchronous data outputs and can be used as a data valid indication. These signals run freely and do not stop when Q tristates.
ZQ	Output Impedance Matching Input: This input is used to tune the device outputs to the system data bus impedance. DQ and CQ output impedance are set to $0.2 \times RQ$, where RQ is a resistor from this bump to ground. This pin cannot be connected directly to GND or left unconnected. Also, in this product, there is no function to minimize the output impedance by connecting ZQ directly to V _{DDQ} .
/DLL	DLL Disable: When LOW, this input causes the DLL to be bypassed for stable low frequency operation.
TMS TDI	IEEE 1149.1 Test Inputs: 1.8V I/O levels. These balls may be left Not Connected if the JTAG function is not used in the circuit.
TCK	IEEE 1149.1 Clock Input: 1.8V I/O levels. This pin must be tied to V _{SS} if the JTAG function is not used in the circuit.
TDO	IEEE 1149.1 Test Output: 1.8V I/O level.
VREF	HSTL Input Reference Voltage: Nominally V _{DDQ} /2. Provides a reference voltage for the input buffers.
VDD	Power Supply: 1.8V nominal. See DC Characteristics and Operating Conditions for range.
VDDQ	Power Supply: Isolated Output Buffer Supply. Nominally 1.5V. 1.8V is also permissible. See DC Characteristics and Operating Conditions for range.
VSS	Power Supply: Ground
NC	No Connect: These signals are internally connected and appear in the JTAG scan chain as the logic level applied to the ball sites. These signals may be connected to ground to improve package heat dissipation.

Block Diagrams

[μPD44165084]

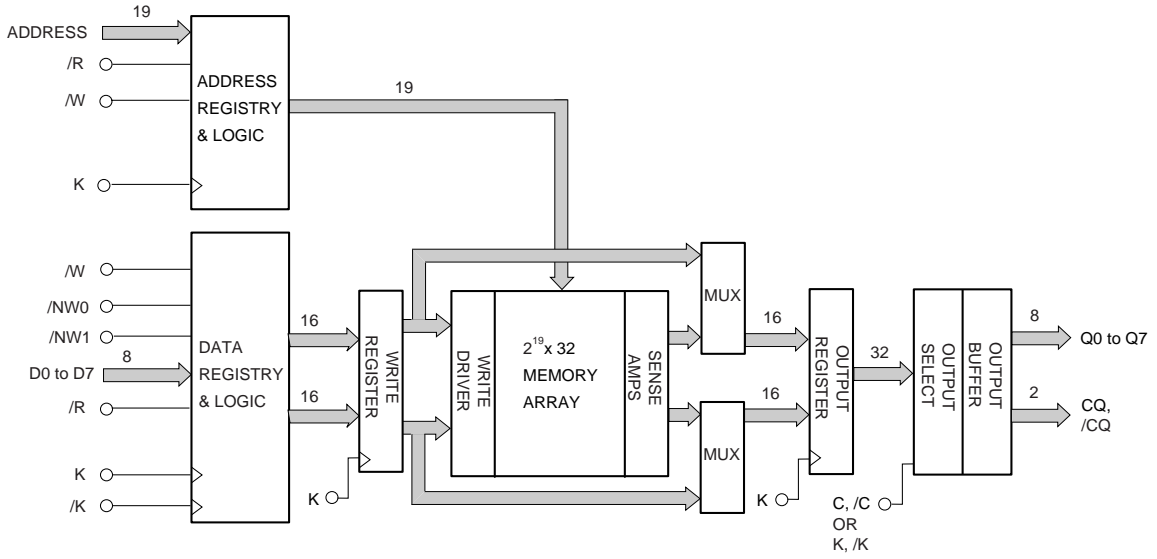

[μPD44165184]

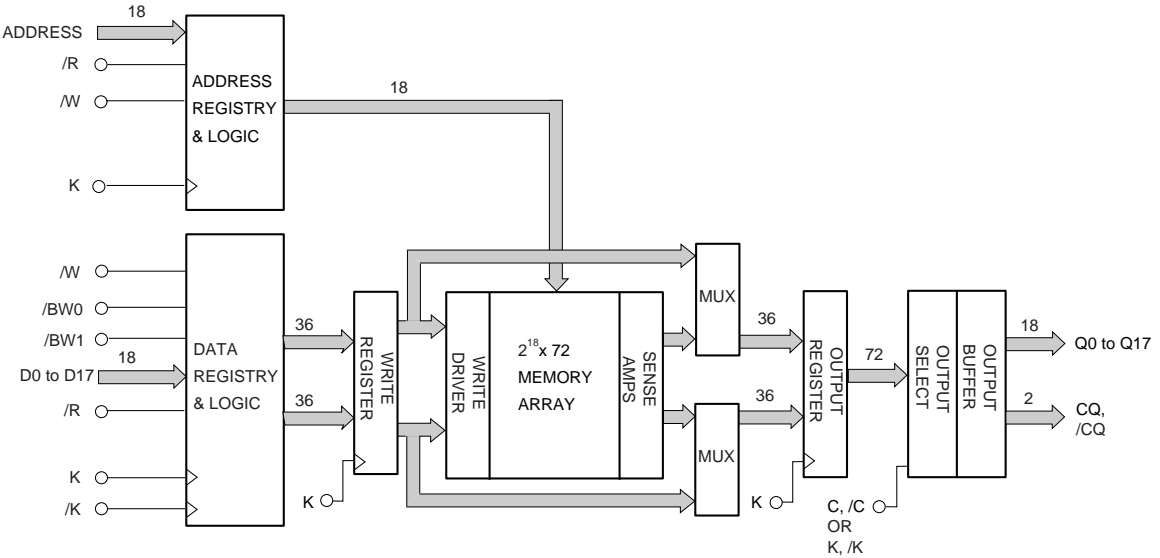

[μPD44165364]

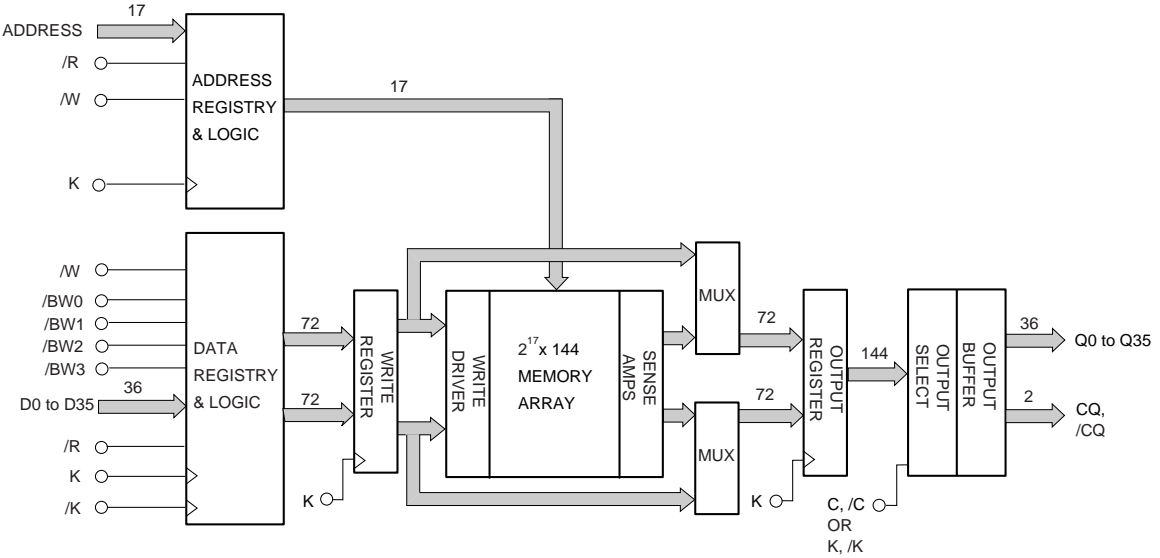

Truth Table

Operation	CLK	/R	/W	D or Q				
WRITE cycle Load address, input write data on two consecutive K and /K rising edge	L → H	H	L	Data in				
				Input data	D _A (A+0)	D _A (A+1)	D _A (A+2)	D _A (A+3)
				Input clock	K(t+1) ↑	/K(t+1) ↑	K(t+2) ↑	/K(t+2) ↑
READ cycle Load address, read data on two consecutive C and /C rising edge	L → H	L	X	Data out				
				Output data	Q _A (A+0)	Q _A (A+1)	Q _A (A+2)	Q _A (A+3)
				Output clock	/C(t+1) ↑	C(t+2) ↑	/C(t+2) ↑	C(t+3) ↑
NOP (No operation)	L → H	H	H	D=X or Q=High-Z				
STANDBY(Clock stopped)	Stopped	X	X	Previous state				

Remarks 1. H : High level, L : Low level, x : don't care, ↑ : rising edge.

2. Data inputs are registered at K and /K rising edges. Data outputs are delivered at C and /C rising edges except if C and /C are HIGH then data outputs are delivered at K and /K rising edges.
3. /R and /W must meet setup/hold times around the rising edge (LOW to HIGH) of K and are registered at the rising edge of K.
4. This device contains circuitry that will ensure the outputs will be in high impedance during power-up.
5. Refer to state diagram and timing diagrams for clarification.
6. It is recommended that K = /(K) = C = /(C) when clock is stopped. This is not essential but permits most rapid restart by overcoming transmission line charging symmetrically.
7. If /R was LOW to initiate the previous cycle, this signal becomes a don't care for this operation however it is strongly recommended that this signal is brought HIGH as shown in the truth table.
8. /W during write cycle and /R during read cycle were HIGH on previous K clock rising edge. Initiating consecutive READ or WRITE operations on consecutive K clock rising edges is not permitted. The device will ignore the second request.

Byte Write Operation

[μPD44165084]

Operation	K	/K	/NW0	/NW1
Write D0 to D7	L → H	–	0	0
	–	L → H	0	0
Write D0 to D3	L → H	–	0	1
	–	L → H	0	1
Write D4 to D7	L → H	–	1	0
	–	L → H	1	0
Write nothing	L → H	–	1	1
	–	L → H	1	1

Remarks 1. H : High level, L : Low level, → : rising edge.

2. Assumes a WRITE cycle was initiated. /NW0 and /NW1 can be altered for any portion of the BURST WRITE operation provided that the setup and hold requirements are satisfied.

[μPD44165184]

Operation	K	/K	/BW0	/BW1
Write D0 to D17	L → H	–	0	0
	–	L → H	0	0
Write D0 to D8	L → H	–	0	1
	–	L → H	0	1
Write D9 to D17	L → H	–	1	0
	–	L → H	1	0
Write nothing	L → H	–	1	1
	–	L → H	1	1

Remarks 1. H : High level, L : Low level, → : rising edge.

2. Assumes a WRITE cycle was initiated. /BW0 and /BW1 can be altered for any portion of the BURST WRITE operation provided that the setup and hold requirements are satisfied.

[μPD44165364]

Operation	K	/K	/BW0	/BW1	/BW2	/BW3
Write D0 to D35	L → H	–	0	0	0	0
	–	L → H	0	0	0	0
Write D0 to D8	L → H	–	0	1	1	1
	–	L → H	0	1	1	1
Write D9 to D17	L → H	–	1	0	1	1
	–	L → H	1	0	1	1
Write D18 to D26	L → H	–	1	1	0	1
	–	L → H	1	1	0	1
Write D27 to D35	L → H	–	1	1	1	0
	–	L → H	1	1	1	0
Write nothing	L → H	–	1	1	1	1
	–	L → H	1	1	1	1

Remarks 1. H : High level, L : Low level, → : rising edge.

2. Assumes a WRITE cycle was initiated. /BW0 to /BW3 can be altered for any portion of the BURST WRITE operation provided that the setup and hold requirements are satisfied.

Bus Cycle State Diagram

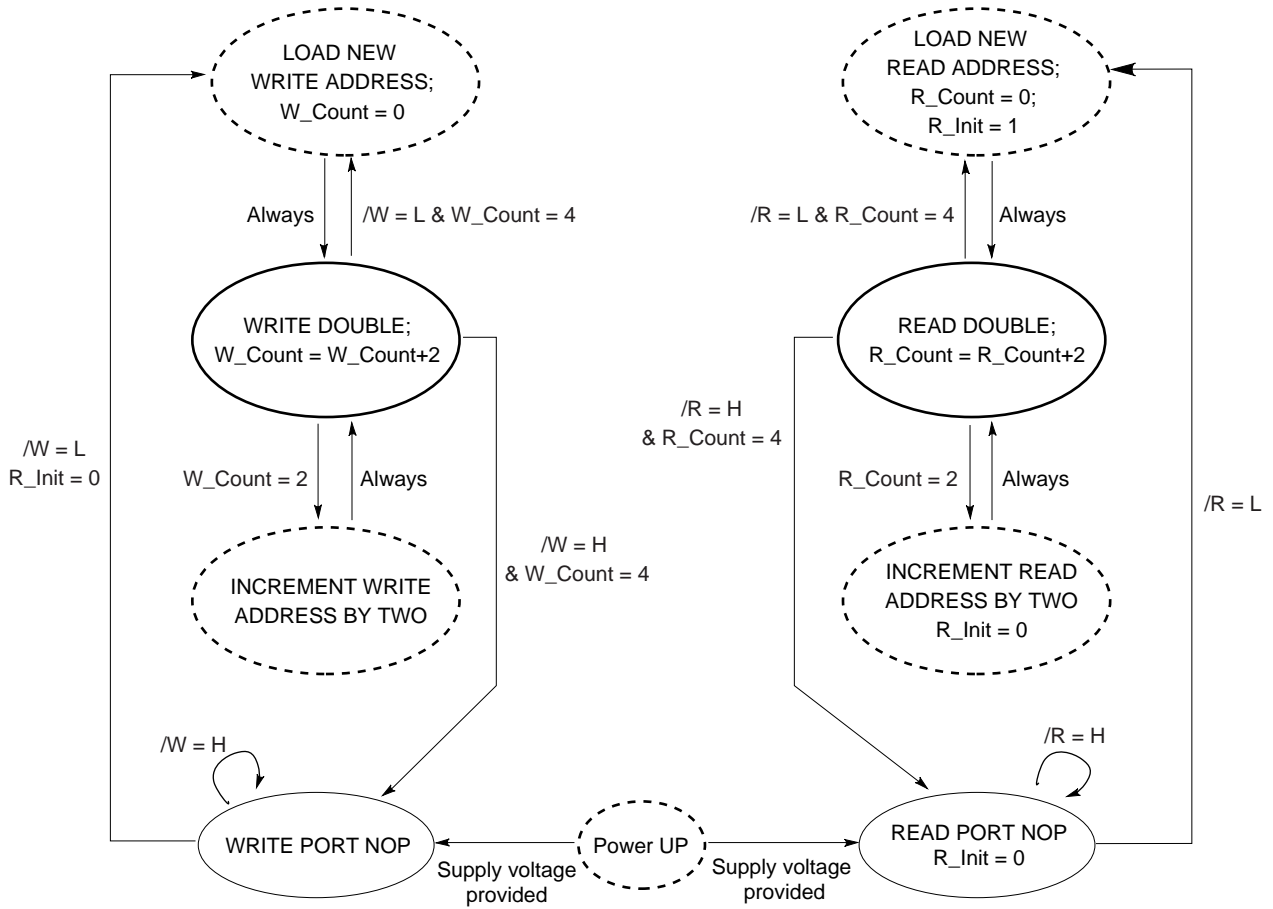

- Remarks**
1. The address is concatenated with two additional internal LSBs to facilitate burst operation. The address order is always fixed as: xxx...xxx+0, xxx...xxx+1, xxx...xxx+2, xxx...xxx+3. Bus cycle is terminated at the end of this sequence (burst count = 4).
 2. Read and write state machines can be active simultaneously. Read and write cannot be simultaneously initiated. Read takes precedence.
 3. State machine control timing is controlled by K.

Electrical Specifications

Absolute Maximum Ratings

Parameter	Symbol	Conditions	MIN.	TYP.	MAX.	Unit
Supply voltage	V _{DD}		-0.5		+2.9	V
Output supply voltage	V _{DDQ}		-0.5		V _{DD}	V
Input voltage	V _{IN}		-0.5		V _{DD} + 0.5 (2.9 V MAX.)	V
Input / Output voltage	V _{I/O}		-0.5		V _{DDQ} + 0.5 (2.9 V MAX.)	V
Operating ambient temperature	T _A		0		70	°C
Storage temperature	T _{stg}		-55		+125	°C

Caution Exposing the device to stress above those listed in Absolute Maximum Ratings could cause permanent damage. The device is not meant to be operated under conditions outside the limits described in the operational section of this specification. Exposure to Absolute Maximum Rating conditions for extended periods may affect device reliability.

Recommended DC Operating Conditions (T_A = 0 to 70 °C)

Parameter	Symbol	Conditions	MIN.	TYP.	MAX.	Unit	Note
Supply voltage	V _{DD}		1.7		1.9	V	
Output supply voltage	V _{DDQ}		1.4		V _{DD}	V	1
High level input voltage	V _{IH} (DC)		V _{REF} + 0.1		V _{DDQ} + 0.3	V	1, 2
Low level input voltage	V _{IL} (DC)		-0.3		V _{REF} - 0.1	V	1, 2
Clock input voltage	V _{IN}		-0.3		V _{DDQ} + 0.3	V	1, 2
Reference voltage	V _{REF}		0.68		0.95	V	

- Notes**
1. During normal operation, V_{DDQ} must not exceed V_{DD}.
 2. Power-up: V_{IH} ≤ V_{DDQ} + 0.3 V and V_{DD} ≤ 1.7 V and V_{DDQ} ≤ 1.4 V for t ≤ 200 ms

Recommended AC Operating Conditions (T_A = 0 to 70 °C)

Parameter	Symbol	Conditions	MIN.	TYP.	MAX.	Unit	Note
High level input voltage	V _{IH} (AC)		V _{REF} + 0.2		-	V	1
Low level input voltage	V _{IL} (AC)		-		V _{REF} - 0.2	V	1

- Note 1.** Overshoot: V_{IH} (AC) ≤ V_{DD} + 0.7 V for t ≤ TKHKH/2
 Undershoot: V_{IL} (AC) ≥ - 0.5 V for t ≤ TKHKH/2
 Control input signals may not have pulse widths less than TKHKL (MIN.) or operate at cycle rates less than TKHKH (MIN.).

DC Characteristics (T_A = 0 to 70°C, V_{DD} = 1.8 ± 0.1 V)

Parameter	Symbol	Test condition	MIN.	TYP.	MAX.		Unit	Note
					x8, x18	x36		
Input leakage current	I _{LI}		-2	-	+2		μA	
I/O leakage current	I _{LO}		-2	-	+2		μA	
★ Operating supply current (Read Write cycle)	I _{DD}	V _{IN} ≤ V _{IL} or V _{IN} ≥ V _{IH} , I _{I/O} = 0 mA Cycle = MAX.	-E40		650	-	mA	
-E50				550	650			
-E60				480	570			
★ Standby supply current (NOP)	I _{SB1}	V _{IN} ≤ V _{IL} or V _{IN} ≥ V _{IH} , I _{I/O} = 0 mA Cycle = MAX.	-E40		320	-	mA	
-E50				270				
-E60				250				
High level output voltage	V _{OH(Low)}	I _{OH} ≤ 0.1 mA	V _{DDQ} - 0.2	-	V _{DDQ}		V	3,4
	V _{OH}	Note1	V _{DDQ} /2 - 0.12	-	V _{DDQ} /2 + 0.12			3,4
Low level output voltage	V _{OL(Low)}	I _{OL} ≤ 0.1 mA	V _{SS}	-	0.2		V	3,4
	V _{OL}	Note2	V _{DDQ} /2 - 0.12	-	V _{DDQ} /2 + 0.12			3,4

- Notes**
1. Outputs are impedance-controlled. |I_{OH}| = (V_{DDQ}/2)/(R_Q/5) for values of 175 Ω ≤ R_Q ≤ 350 Ω.
 2. Outputs are impedance-controlled. I_{OL} = (V_{DDQ}/2)/(R_Q/5) for values of 175 Ω ≤ R_Q ≤ 350 Ω.
 3. AC load current is higher than the shown DC values.
 4. HSTL outputs meet JEDEC HSTL Class I and Class II standards.

Capacitance (T_A = 25 °C, f = 1MHz)

Parameter	Symbol	Test conditions	MIN.	TYP.	MAX.	Unit
Input capacitance(Address, Control)	C _{IN}	V _{IN} = 0 V		4	5	pF
Input / Output capacitance(D, Q)	C _{I/O}	V _{I/O} = 0 V		6	7	pF
Clock Input capacitance	C _{clk}	V _{clk} = 0 V		5	6	pF

Remark These parameters are periodically sampled and not 100% tested.

AC Characteristics ($T_A = 0$ to 70 °C, $V_{DD} = 1.8 \pm 0.1$ V)

AC Test Conditions

Input waveform (Rise / Fall time ≤ 0.3 ns)

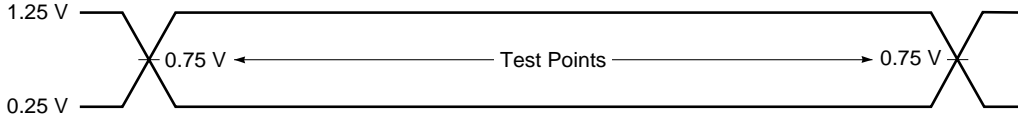

Output waveform

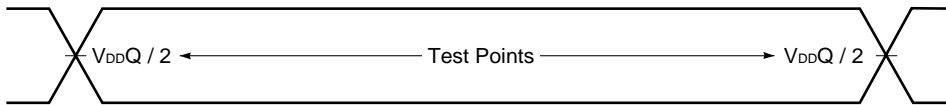

Output load condition

Figure 1. External load at test

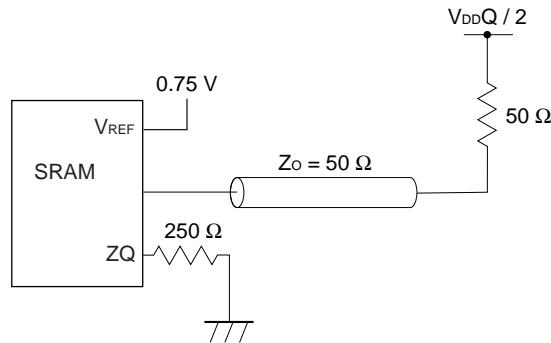

Read and Write Cycle

Parameter	Symbol	-E40 (250 MHz)		-E50 (200 MHz)		-E60 (167 MHz)		Unit	Note	
		MIN.	MAX.	MIN.	MAX.	MIN.	MAX.			
Clock										
Average Clock cycle time (K, /K, C, /C)	TKHKH	4.0	8.4	5.0	8.4	6.0	8.4	ns	1	
Clock phase jitter (K, /K, C, /C)	TKC var	–	0.2	–	0.2	–	0.2	ns	2	
Clock HIGH time (K, /K, C, /C)	TKHKL	1.6	–	2.0	–	2.4	–	ns		
Clock LOW time (K, /K, C, /C)	TKLKH	1.6	–	2.0	–	2.4	–	ns		
Clock to /clock (K→/K., C→/C.)	TKH /KH	1.8	–	2.2	–	2.7	–	ns		
Clock to /clock (/K→K., /C→C.)	T /KHKH	1.8	–	2.2	–	2.7	–	ns		
Clock to data clock (K→C., /K→/C.)	TKHCH	200 to 250 MHz	0	1.8	–	–	–	–	ns	
		167 to 200 MHz	0	2.3	0	2.3	–	–		
		133 to 167 MHz	0	2.8	0	2.8	0	2.8		
		< 133 MHz	0	3.55	0	3.55	0	3.55		
DLL lock time (K, C)	TKC lock	1,024	–	1,024	–	1,024	–	Cycle	3	
K static to DLL reset	TKC reset	30	–	30	–	30	–	ns		
Output Times										
C, /C HIGH to output valid	TCHQV	–	0.45	–	0.45	–	0.5	ns		
C, /C HIGH to output hold	TCHQX	–0.45	–	–0.45	–	–0.5	–	ns		
C, /C HIGH to echo clock valid	TCHCQV	–	0.45	–	0.45	–	0.5	ns		
C, /C HIGH to echo clock hold	TCHCQX	–0.45	–	–0.45	–	–0.5	–	ns		
CQ, /CQ HIGH to output valid	TCQHQV	–	0.3	–	0.35	–	0.4	ns	4	
CQ, /CQ HIGH to output hold	TCQHQX	–0.3	–	–0.35	–	–0.4	–	ns	4	
C HIGH to output High-Z	TCHQZ	–	0.45	–	0.45	–	0.5	ns		
C HIGH to output Low-Z	TCHQX1	–0.45	–	–0.45	–	–0.5	–	ns		
Setup Times										
Address valid to K rising edge	TAVKH	0.5	–	0.6	–	0.7	–	ns	5	
Control inputs (/R, /W) valid to K rising edge	TIVKH	0.5	–	0.6	–	0.7	–	ns	5	
Data inputs and write data select inputs (/BWx, /NWx) valid to K, /K rising edge	TDVKH	0.35	–	0.4	–	0.5	–	ns	5	
Hold Times										
K rising edge to address hold	TKHAX	0.5	–	0.6	–	0.7	–	ns	5	
K rising edge to control inputs (/R, /W) hold	TKHIX	0.5	–	0.6	–	0.7	–	ns	5	
K, /K rising edge to data inputs and write data select inputs (/BWx, /NWx) hold	TKHDX	0.35	–	0.4	–	0.5	–	ns	5	

- Notes**
1. The device will operate at clock frequencies slower than TKHKH(MAX.).
 2. Clock phase jitter is the variance from clock rising edge to the next expected clock rising edge.
 3. V_{DD} slew rate must be less than 0.1 V DC per 50 ns for DLL lock retention.
DLL lock time begins once V_{DD} and input clock are stable.
It is recommended that the device is kept inactive during these cycles.
 4. Echo clock is very tightly controlled to data valid / data hold. By design, there is a ± 0.1 ns variation from echo clock to data. The data sheet parameters reflect tester guardbands and test setup variations.
 5. This is a synchronous device. All addresses, data and control lines must meet the specified setup and hold times for all latching clock edges.

- Remarks**
1. This parameter is sampled.
 2. Test conditions as specified with the output loading as shown in AC Test Conditions unless otherwise noted.
 3. Control input signals may not be operated with pulse widths less than TKHKL (MIN.).
 4. If C, /C are tied HIGH, K, /K become the references for C, /C timing parameters.
 5. V_{DDQ} is 1.5 V DC.

Read and Write Timing

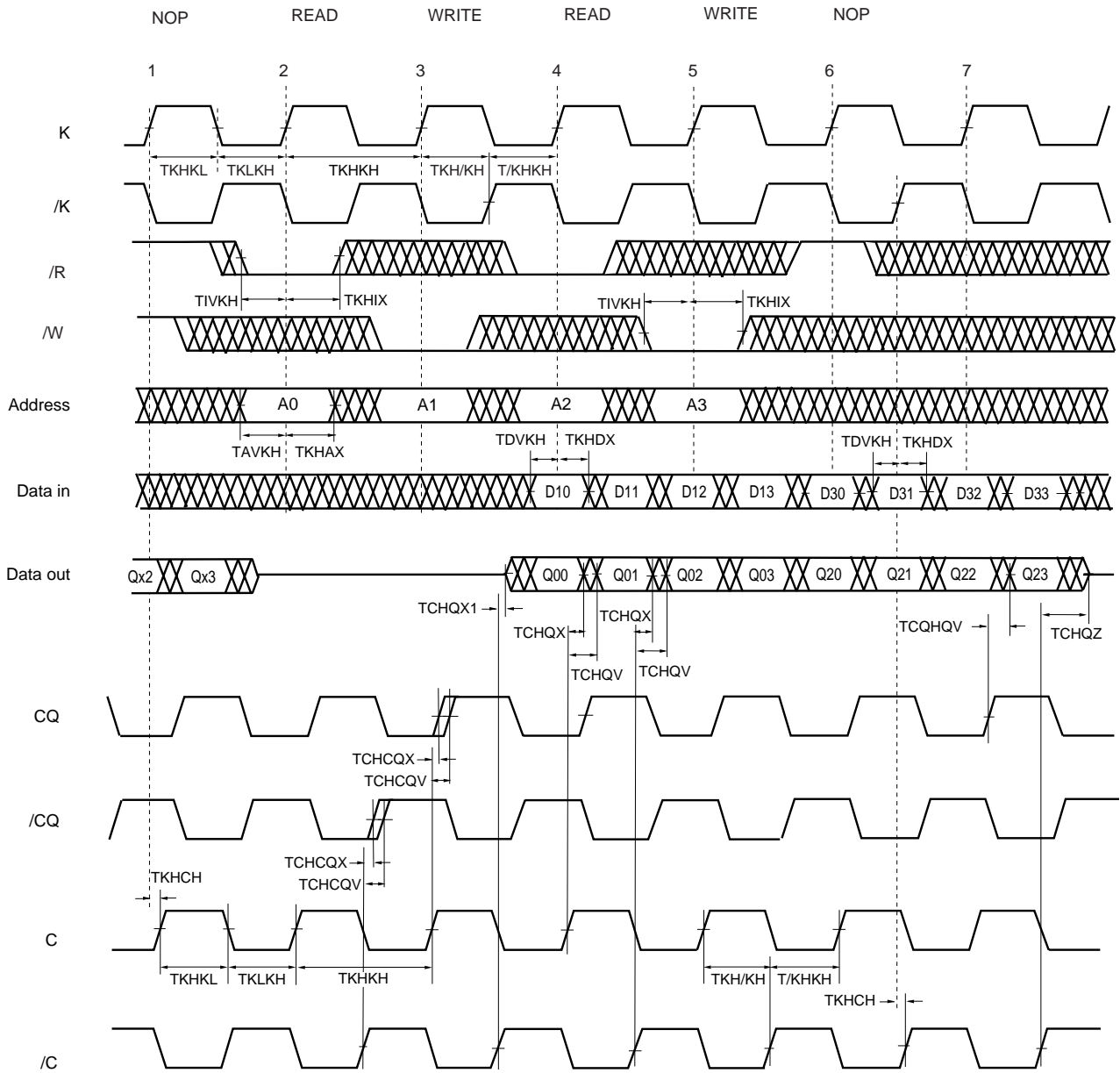

- Remarks**
1. Q00 refers to output from address A0+0.
Q01 refers to output from the next internal burst address following A0, i.e., A0+1.
 2. Outputs are disable (high impedance) one clock cycle after a NOP.
 3. In this example, if address A1=A2, data Q20=D10, Q21=D11.
Write data is forwarded immediately as read results.

JTAG Specification

These products support a limited set of JTAG functions as in IEEE standard 1149.1.

Test Access Port (TAP) Pins

Pin name	Pin assignments	Description
TCK	2R	Test Clock Input. All input are captured on the rising edge of TCK and all outputs propagate from the falling edge of TCK.
TMS	10R	Test Mode Select. This is the command input for the TAP controller state machine.
TDI	11R	Test Data Input. This is the input side of the serial registers placed between TDI and TDO. The register placed between TDI and TDO is determined by the state of the TAP controller state machine and the instruction that is currently loaded in the TAP instruction.
TDO	1R	Test Data Output. Output changes in response to the falling edge of TCK. This is the output side of the serial registers placed between TDI and TDO.

Remark The device does not have TRST (TAP reset). The Test-Logic Reset state is entered while TMS is held high for five rising edges of TCK. The TAP controller state is also reset on the SRAM POWER-UP.

JTAG DC Characteristics (T_A = 0 to 70°C, V_{DD} = 1.8 ± 0.1 V, unless otherwise noted)

Parameter	Symbol	Conditions	MIN.	TYP.	MAX.	Unit	Note
JTAG Input leakage current	I _{LI}	0 V ≤ V _{IN} ≤ V _{DD}	-5.0	-	+5.0	μA	
JTAG I/O leakage current	I _{LO}	0 V ≤ V _{IN} ≤ V _{DDQ} , Outputs disabled	-5.0	-	+5.0	μA	
JTAG input high voltage	V _{IH}		1.3	-	V _{DD} + 0.3	V	
JTAG input low voltage	V _{IL}		-0.3	-	+0.5	V	
JTAG output high voltage	V _{OH1}	I _{OH} C = 100 μA	1.6	-	-	V	
	V _{OH2}	I _{OH} T = 2 mA	1.4	-	-	V	
JTAG output low voltage	V _{OL1}	I _{OL} C = 100 μA	-	-	0.2	V	
	V _{OL2}	I _{OL} T = 2 mA	-	-	0.4	V	

JTAG AC Test Conditions

Input waveform (Rise / Fall time ≤ 1 ns)

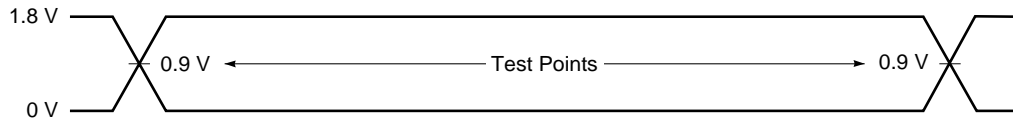

Output waveform

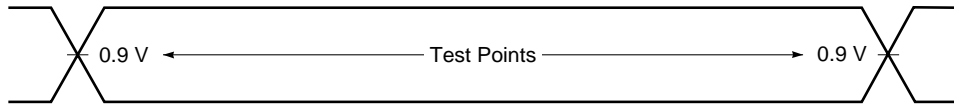

Output load

Figure 2. External load at test

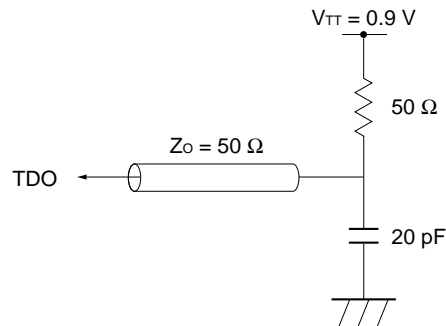

JTAG AC Characteristics (T_A = 0 to 70 °C)

Parameter	Symbol	Conditions	MIN.	TYP.	MAX.	Unit	Note
Clock							
Clock cycle time	t _{THTH}		100	–	–	ns	
Clock frequency	f _{TF}		–	–	10	MHz	
Clock high time	t _{THTL}		40	–	–	ns	
Clock low time	t _{TLTH}		40	–	–	ns	
Output time							
TCK low to TDO unknown	t _{TLOX}		0	–	–	ns	
TCK low to TDO valid	t _{TLOV}		–	–	20	ns	
TDI valid to TCK high	t _{DVTH}		10	–	–	ns	
TCK high to TDI invalid	t _{THDX}		10	–	–	ns	
Setup time							
TMS setup time	t _{MVTH}		10	–	–	ns	
Capture setup time	t _{CS}		10	–	–	ns	
Hold time							
TMS hold time	t _{THMX}		10	–	–	ns	
Capture hold time	t _{CH}		10	–	–	ns	

JTAG Timing Diagram

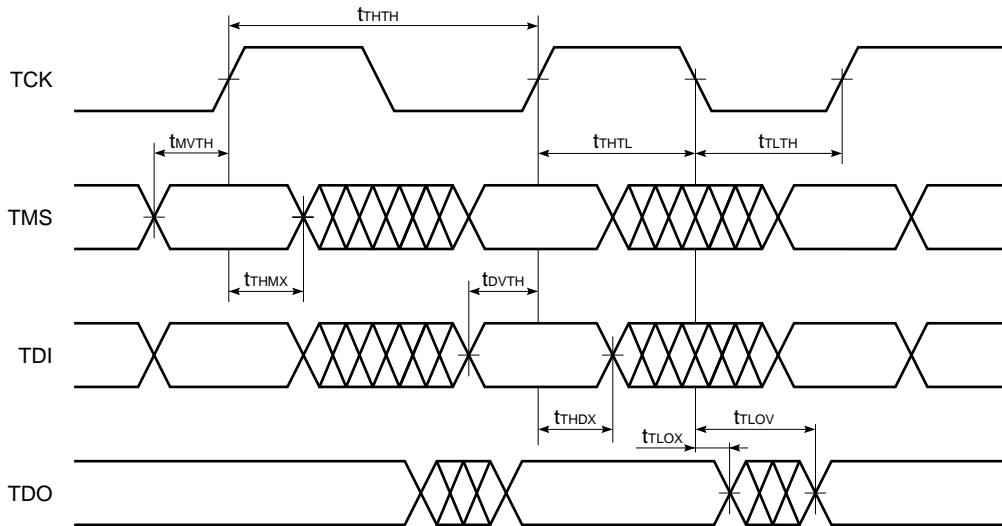

Scan Register Definition (1)

Register name	Description
Instruction register	The instruction register holds the instructions that are executed by the TAP controller when it is moved into the run-test/idle or the various data register state. The register can be loaded when it is placed between the TDI and TDO pins. The instruction register is automatically preloaded with the IDCODE instruction at power-up whenever the controller is placed in test-logic-reset state.
Bypass register	The bypass register is a single bit register that can be placed between TDI and TDO. It allows serial test data to be passed through the RAMs TAP to another device in the scan chain with as little delay as possible.
ID register	The ID Register is a 32 bit register that is loaded with a device and vendor specific 32 bit code when the controller is put in capture-DR state with the IDCODE command loaded in the instruction register. The register is then placed between the TDI and TDO pins when the controller is moved into shift-DR state.
Boundary register	The boundary register, under the control of the TAP controller, is loaded with the contents of the RAMs I/O ring when the controller is in capture-DR state and then is placed between the TDI and TDO pins when the controller is moved to shift-DR state. Several TAP instructions can be used to activate the boundary register. The Scan Exit Order tables describe which device bump connects to each boundary register location. The first column defines the bit's position in the boundary register. The second column is the name of the input or I/O at the bump and the third column is the bump number.

Scan Register Definition (2)

Register name	Bit size	Unit
Instruction register	3	bit
Bypass register	1	bit
ID register	32	bit
Boundary register	107	bit

ID Register Definition

Part number	Organization	ID [31:28] vendor revision no.	ID [27:12] part no.	ID [11:1] vendor ID no.	ID [0] fix bit
μPD44165084	2M x 8	XXXX	0000 0000 0000 1111	00000010000	1
μPD44165184	1M x 18	XXXX	0000 0000 0001 0000	00000010000	1
μPD44165364	512K x 36	XXXX	0000 0000 0001 0001	00000010000	1

SCAN Exit Order

Bit no.	Signal name			Bump ID
	x8	x18	x36	
1	/C			6R
2	C			6P
3	A			6N
4	A			7P
5	A			7N
6	A			7R
7	A			8R
8	A			8P
9	A			9R
10	NC	Q0	Q0	11P
11	NC	D0	D0	10P
12	NC	NC	D9	10N
13	NC	NC	Q9	9P
14	NC	Q1	Q1	10M
15	NC	D1	D1	11N
16	NC	NC	D10	9M
17	NC	NC	Q10	9N
18	Q0	Q2	Q2	11L
19	D0	D2	D2	11M
20	NC	NC	D11	9L
21	NC	NC	Q11	10L
22	NC	Q3	Q3	11K
23	NC	D3	D3	10K
24	NC	NC	D12	9J
25	NC	NC	Q12	9K
26	Q1	Q4	Q4	10J
27	D1	D4	D4	11J
28	ZQ			11H
29	NC	NC	D13	10G
30	NC	NC	Q13	9G
31	NC	Q5	Q5	11F
32	NC	D5	D5	11G
33	NC	NC	D14	9F
34	NC	NC	Q14	10F
35	Q2	Q6	Q6	11E
36	D2	D6	D6	10E

Bit no.	Signal name			Bump ID
	x8	x18	x36	
37	NC	NC	D15	10D
38	NC	NC	Q15	9E
39	NC	Q7	Q7	10C
40	NC	D7	D7	11D
41	NC	NC	D16	9C
42	NC	NC	Q16	9D
43	Q3	Q8	Q8	11B
44	D3	D8	D8	11C
45	NC	NC	D17	9B
46	NC	NC	Q17	10B
47	CQ			11A
48	-			Internal
49	A	A	NC	9A
50	A			8B
51	A			7C
52	NC			6C
53	/R			8A
54	NC	NC	/BW1	7A
55	/NW0	/BW0	/BW0	7B
56	K			6B
57	/K			6A
58	NC	NC	/BW3	5B
59	/NW1	/BW1	/BW2	5A
60	/W			4A
61	A			5C
62	A			4B
63	A	NC	NC	3A
64	/DLL			1H
65	/CQ			1A
66	NC	Q9	Q18	2B
67	NC	D9	D18	3B
68	NC	NC	D27	1C
69	NC	NC	Q27	1B
70	NC	Q10	Q19	3D
71	NC	D10	D19	3C
72	NC	NC	D28	1D

Bit no.	Signal name			Bump ID
	x8	x18	x36	
73	NC	NC	Q28	2C
74	Q4	Q11	Q20	3E
75	D4	D11	D20	2D
76	NC	NC	D29	2E
77	NC	NC	Q29	1E
78	NC	Q12	Q21	2F
79	NC	D12	D21	3F
80	NC	NC	D30	1G
81	NC	NC	Q30	1F
82	Q5	Q13	Q22	3G
83	D5	D13	D22	2G
84	NC	NC	D31	1J
85	NC	NC	Q31	2J
86	NC	Q14	Q23	3K
87	NC	D14	D23	3J
88	NC	NC	D32	2K
89	NC	NC	Q32	1K
90	Q6	Q15	Q24	2L
91	D6	D15	D24	3L
92	NC	NC	D33	1M
93	NC	NC	Q33	1L
94	NC	Q16	Q25	3N
95	NC	D16	D25	3M
96	NC	NC	D34	1N
97	NC	NC	Q34	2M
98	Q7	Q17	Q26	3P
99	D7	D17	D26	2N
100	NC	NC	D35	2P
101	NC	NC	Q35	1P
102	A			3R
103	A			4R
104	A			4P
105	A			5P
106	A			5N
107	A			5R

JTAG Instructions

Instructions	Description
EXTEST	The EXTEST instruction allows circuitry external to the component package to be tested. Boundary-scan register cells at output pins are used to apply test vectors, while those at input pins capture test results. Typically, the first test vector to be applied using the EXTEST instruction will be shifted into the boundary scan register using the PRELOAD instruction. Thus, during the update-IR state of EXTEST, the output driver is turned on and the PRELOAD data is driven onto the output pins.
IDCODE	The IDCODE instruction causes the ID ROM to be loaded into the ID register when the controller is in capture-DR mode and places the ID register between the TDI and TDO pins in shift-DR mode. The IDCODE instruction is the default instruction loaded in at power up and any time the controller is placed in the test-logic-reset state.
BYPASS	The BYPASS instruction is loaded in the instruction register when the bypass register is placed between TDI and TDO. This occurs when the TAP controller is moved to the shift-DR state. This allows the board level scan path to be shortened to facilitate testing of other devices in the scan path.
SAMPLE / PRELOAD	SAMPLE / PRELOAD is a Standard 1149.1 mandatory public instruction. When the SAMPLE / PRELOAD instruction is loaded in the instruction register, moving the TAP controller into the capture-DR state loads the data in the RAMs input and Q pins into the boundary scan register. Because the RAM clock(s) are independent from the TAP clock (TCK) it is possible for the TAP to attempt to capture the I/O ring contents while the input buffers are in transition (i.e., in a metastable state). Although allowing the TAP to sample metastable input will not harm the device, repeatable results cannot be expected. RAM input signals must be stabilized for long enough to meet the TAPs input data capture setup plus hold time (t_{CS} plus t_{CH}). The RAMs clock inputs need not be paused for any other TAP operation except capturing the I/O ring contents into the boundary scan register. Moving the controller to shift-DR state then places the boundary scan register between the TDI and TDO pins.
SAMPLE-Z	If the SAMPLE-Z instruction is loaded in the instruction register, all RAM Q pins are forced to an inactive drive state (high impedance) and the boundary register is connected between TDI and TDO when the TAP controller is moved to the shift-DR state.

JTAG Instruction Coding

IR2	IR1	IR0	Instruction	Note
0	0	0	EXTEST	
0	0	1	IDCODE	
0	1	0	SAMPLE-Z	1
0	1	1	RESERVED	
1	0	0	SAMPLE / PRELOAD	
1	0	1	RESERVED	
1	1	0	RESERVED	
1	1	1	BYPASS	

Note 1. TRISTATE all Q pins and CAPTURE the pad values into a SERIAL SCAN LATCH.

TAP Controller State Diagram

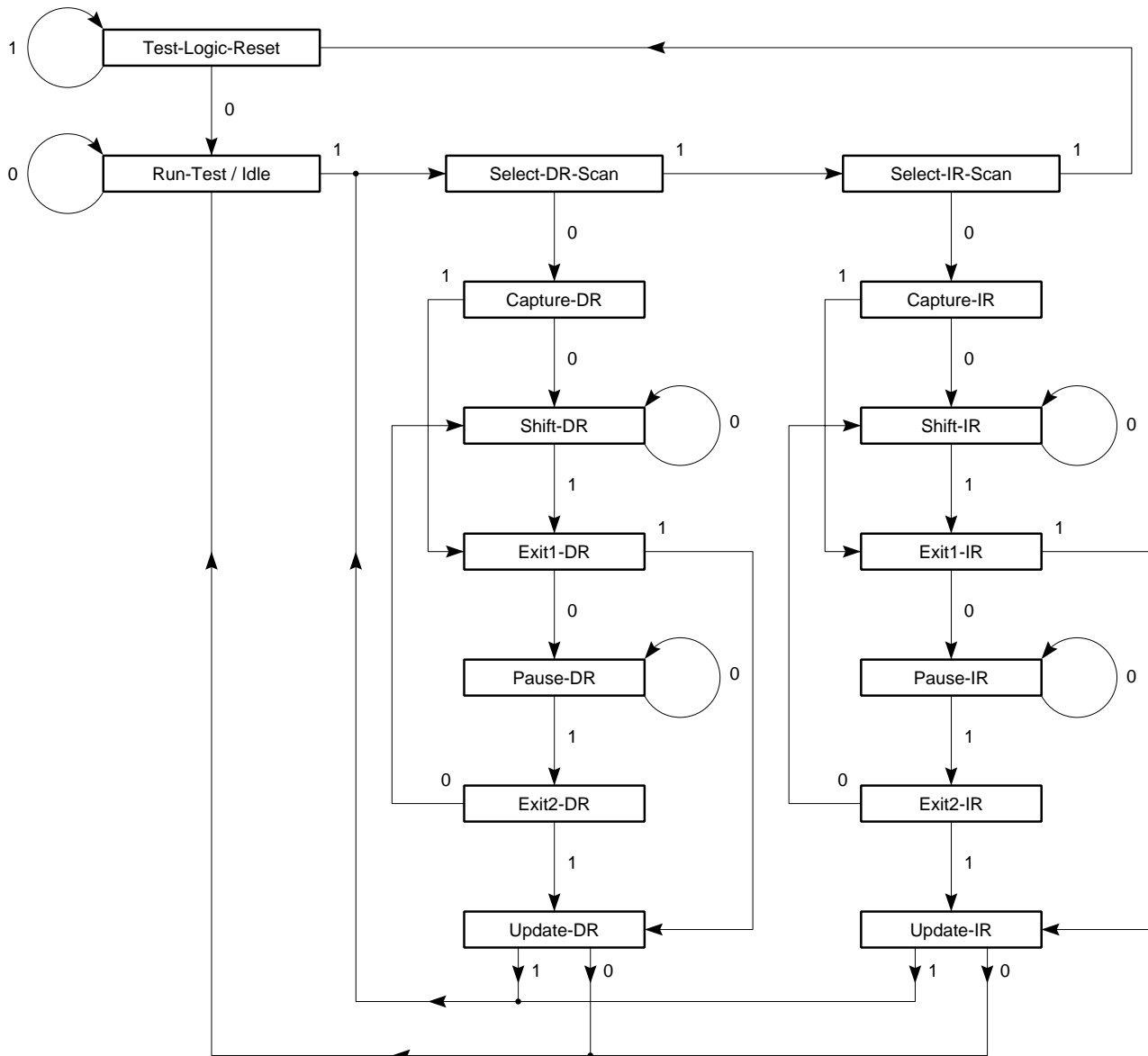

Disabling the Test Access Port

It is possible to use this device without utilizing the TAP. To disable the TAP Controller without interfering with normal operation of the device, TCK must be tied to Vss to preclude mid level inputs.

TDI and TMS are designed so an undriven input will produce a response identical to the application of a logic 1, and may be left unconnected. But they may also be tied to VDD through a 1 kΩ resistor.

TDO should be left unconnected.

Test Logic Operation (Instruction Scan)

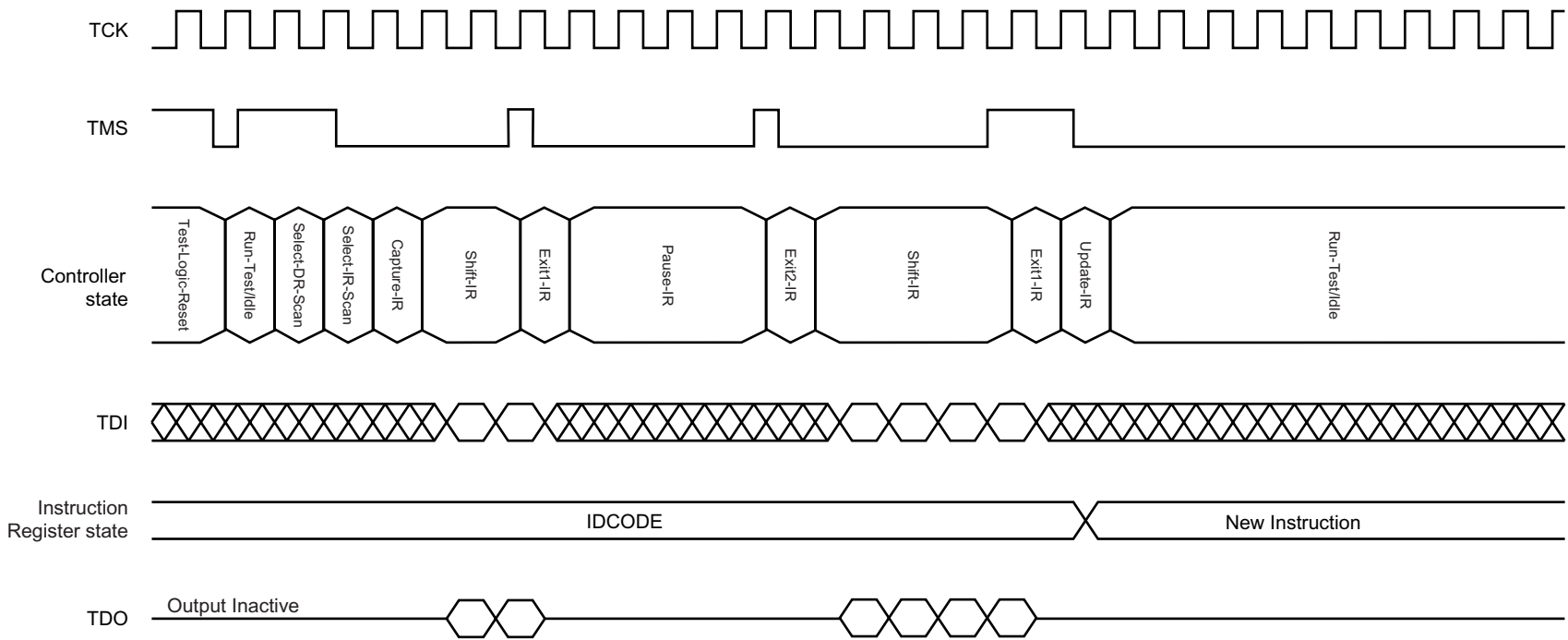

Test Logic (Data Scan)

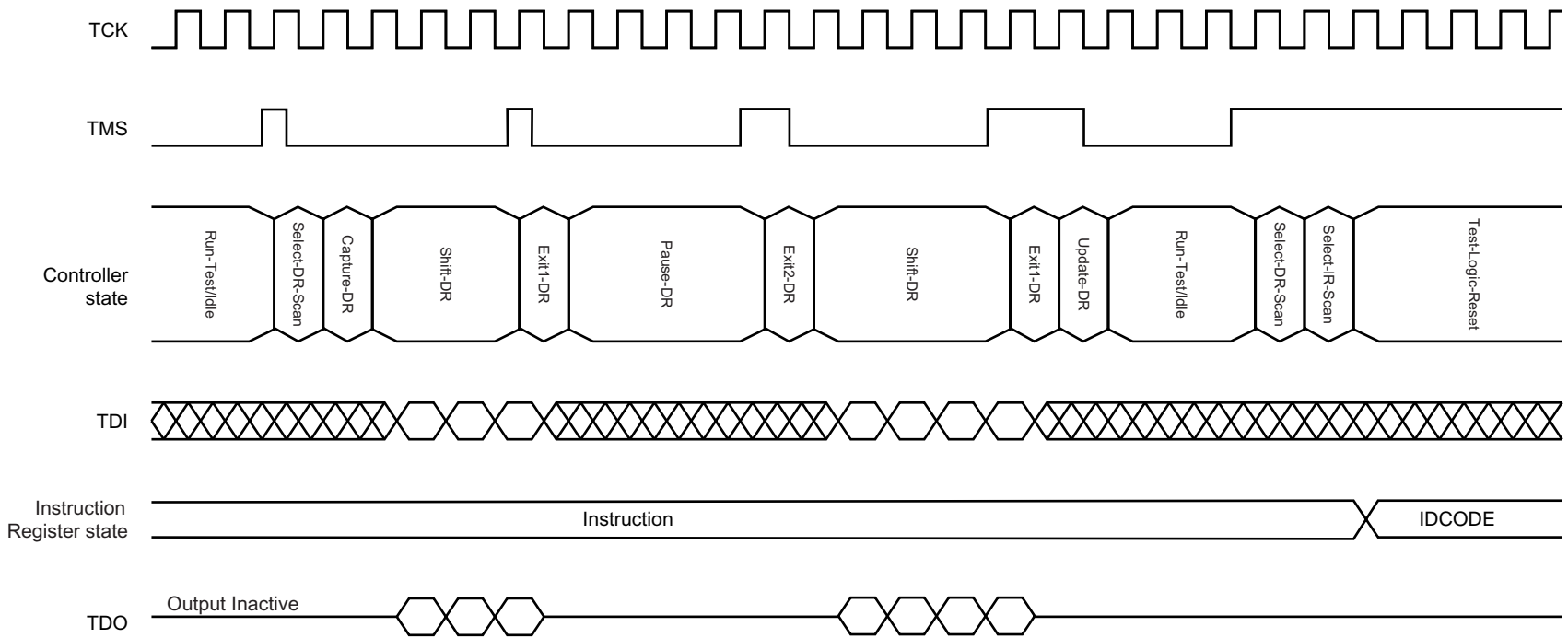

★ Package Drawing

165-PIN PLASTIC BGA (13x15)

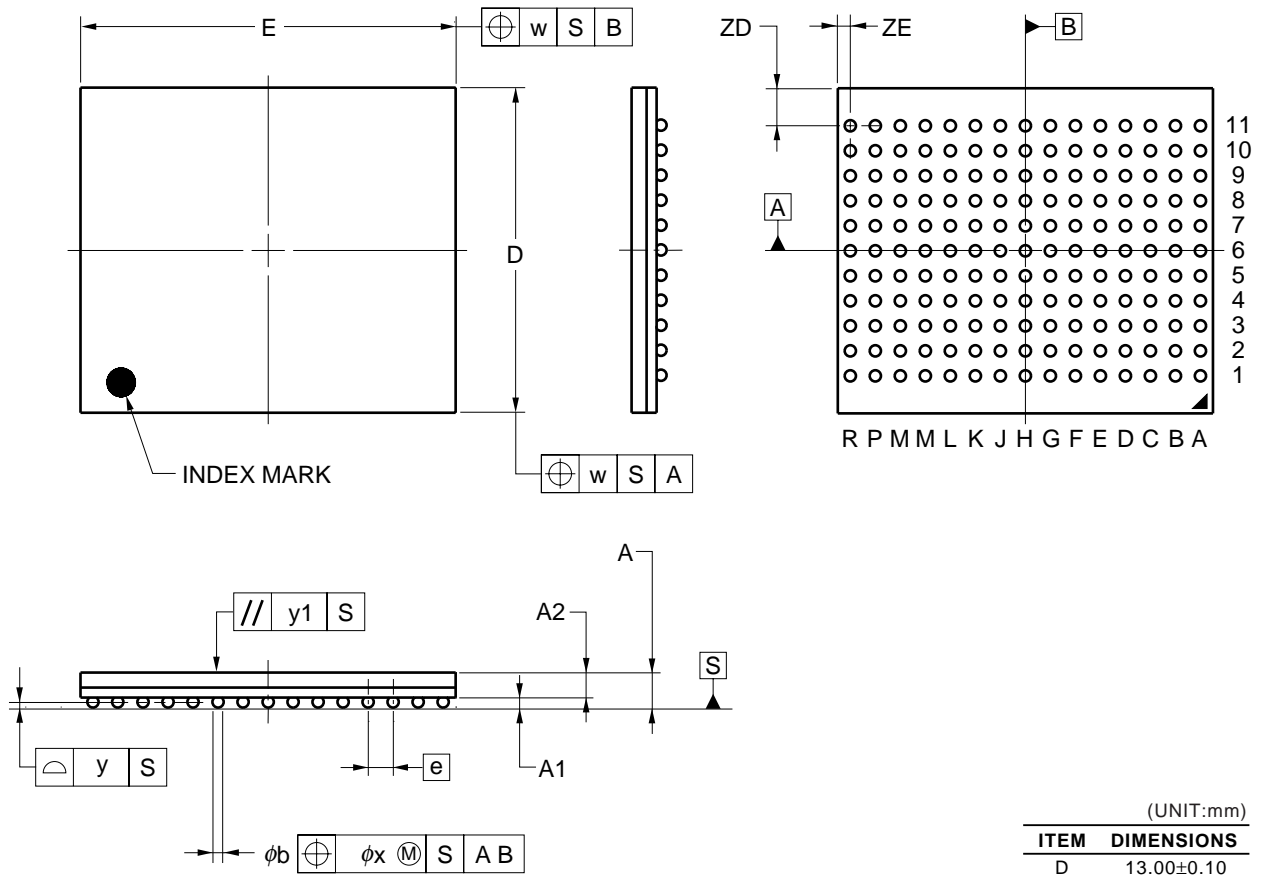

(UNIT:mm)

ITEM	DIMENSIONS
D	13.00±0.10
E	15.00±0.10
w	0.15
e	1.00
A	1.40±0.11
A1	0.40±0.05
A2	1.00
b	0.50±0.05
x	0.08
y	0.10
y1	0.20
ZD	1.50
ZE	0.50

P165F5-100-EQ1

Recommended Soldering Condition

Please consult with our sales offices for soldering conditions of these products.



Types of Surface Mount Devices

μ PD44165084F5-EQ1: 165-pin PLASTIC BGA (13 x 15)

μ PD44165184F5-EQ1: 165-pin PLASTIC BGA (13 x 15)

μ PD44165364F5-EQ1: 165-pin PLASTIC BGA (13 x 15)

Revision History

Edition/ Date	Page		Type of revision	Location	Description (Previous edition → This edition)																																
	This edition	Previous edition																																			
7th edition/ Feb. 2004	Throughout	Throughout	Deletion	Ordering Information	μPD44165364F5-E40-EQ1																																
	p.12	p.12	Modification	DC Characteristics I _{DD} (MAX.)	<table border="1"> <thead> <tr> <th rowspan="2"></th> <th colspan="2">MAX.</th> <th rowspan="2">Unit</th> </tr> <tr> <th>x8, x18</th> <th>x36</th> </tr> </thead> <tbody> <tr> <td>-E40</td> <td>600</td> <td>TBD</td> <td rowspan="3">mA</td> </tr> <tr> <td>-E50</td> <td>500</td> <td>600</td> </tr> <tr> <td>-E60</td> <td>430</td> <td>520</td> </tr> </tbody> </table>  <table border="1"> <thead> <tr> <th rowspan="2"></th> <th colspan="2">MAX.</th> <th rowspan="2">Unit</th> </tr> <tr> <th>x8, x18</th> <th>x36</th> </tr> </thead> <tbody> <tr> <td>-E40</td> <td>650</td> <td>-</td> <td rowspan="3">mA</td> </tr> <tr> <td>-E50</td> <td>550</td> <td>650</td> </tr> <tr> <td>-E60</td> <td>480</td> <td>570</td> </tr> </tbody> </table>		MAX.		Unit	x8, x18	x36	-E40	600	TBD	mA	-E50	500	600	-E60	430	520		MAX.		Unit	x8, x18	x36	-E40	650	-	mA	-E50	550	650	-E60	480	570
	MAX.		Unit																																		
	x8, x18	x36																																			
-E40	600	TBD	mA																																		
-E50	500	600																																			
-E60	430	520																																			
	MAX.		Unit																																		
	x8, x18	x36																																			
-E40	650	-	mA																																		
-E50	550	650																																			
-E60	480	570																																			
				DC Characteristics I _{SB1} (MAX.)	<table border="1"> <thead> <tr> <th rowspan="2"></th> <th colspan="2">MAX.</th> <th rowspan="2">Unit</th> </tr> <tr> <th>x8, x18</th> <th>x36</th> </tr> </thead> <tbody> <tr> <td>-E40</td> <td colspan="2">250</td> <td rowspan="3">mA</td> </tr> <tr> <td>-E50</td> <td colspan="2">210</td> </tr> <tr> <td>-E60</td> <td colspan="2">190</td> </tr> </tbody> </table>  <table border="1"> <thead> <tr> <th rowspan="2"></th> <th colspan="2">MAX.</th> <th rowspan="2">Unit</th> </tr> <tr> <th>x8, x18</th> <th>x36</th> </tr> </thead> <tbody> <tr> <td>-E40</td> <td>320</td> <td>-</td> <td rowspan="3">mA</td> </tr> <tr> <td>-E50</td> <td colspan="2">270</td> </tr> <tr> <td>-E60</td> <td colspan="2">250</td> </tr> </tbody> </table>		MAX.		Unit	x8, x18	x36	-E40	250		mA	-E50	210		-E60	190			MAX.		Unit	x8, x18	x36	-E40	320	-	mA	-E50	270		-E60	250	
	MAX.		Unit																																		
	x8, x18	x36																																			
-E40	250		mA																																		
-E50	210																																				
-E60	190																																				
	MAX.		Unit																																		
	x8, x18	x36																																			
-E40	320	-	mA																																		
-E50	270																																				
-E60	250																																				
	p.26	p.26	Modification	Package Drawing	Preliminary version → Standardized version																																

[MEMO]

[MEMO]

NOTES FOR CMOS DEVICES

① VOLTAGE APPLICATION WAVEFORM AT INPUT PIN

Waveform distortion due to input noise or a reflected wave may cause malfunction. If the input of the CMOS device stays in the area between V_{IL} (MAX) and V_{IH} (MIN) due to noise, etc., the device may malfunction. Take care to prevent chattering noise from entering the device when the input level is fixed, and also in the transition period when the input level passes through the area between V_{IL} (MAX) and V_{IH} (MIN).

② HANDLING OF UNUSED INPUT PINS

Unconnected CMOS device inputs can be cause of malfunction. If an input pin is unconnected, it is possible that an internal input level may be generated due to noise, etc., causing malfunction. CMOS devices behave differently than Bipolar or NMOS devices. Input levels of CMOS devices must be fixed high or low by using pull-up or pull-down circuitry. Each unused pin should be connected to V_{DD} or GND via a resistor if there is a possibility that it will be an output pin. All handling related to unused pins must be judged separately for each device and according to related specifications governing the device.

③ PRECAUTION AGAINST ESD

A strong electric field, when exposed to a MOS device, can cause destruction of the gate oxide and ultimately degrade the device operation. Steps must be taken to stop generation of static electricity as much as possible, and quickly dissipate it when it has occurred. Environmental control must be adequate. When it is dry, a humidifier should be used. It is recommended to avoid using insulators that easily build up static electricity. Semiconductor devices must be stored and transported in an anti-static container, static shielding bag or conductive material. All test and measurement tools including work benches and floors should be grounded. The operator should be grounded using a wrist strap. Semiconductor devices must not be touched with bare hands. Similar precautions need to be taken for PW boards with mounted semiconductor devices.

④ STATUS BEFORE INITIALIZATION

Power-on does not necessarily define the initial status of a MOS device. Immediately after the power source is turned ON, devices with reset functions have not yet been initialized. Hence, power-on does not guarantee output pin levels, I/O settings or contents of registers. A device is not initialized until the reset signal is received. A reset operation must be executed immediately after power-on for devices with reset functions.

QDR RAMs and Quad Data Rate RAMs comprise a new family of products developed by Cypress Semiconductor, Renesas, IDT, Micron Technology, Inc., NEC Electronics, and Samsung.

- **The information in this document is current as of July, 2004. The information is subject to change without notice. For actual design-in, refer to the latest publications of NEC Electronics data sheets or data books, etc., for the most up-to-date specifications of NEC Electronics products. Not all products and/or types are available in every country. Please check with an NEC Electronics sales representative for availability and additional information.**

- No part of this document may be copied or reproduced in any form or by any means without the prior written consent of NEC Electronics. NEC Electronics assumes no responsibility for any errors that may appear in this document.

- NEC Electronics does not assume any liability for infringement of patents, copyrights or other intellectual property rights of third parties by or arising from the use of NEC Electronics products listed in this document or any other liability arising from the use of such products. No license, express, implied or otherwise, is granted under any patents, copyrights or other intellectual property rights of NEC Electronics or others.

- Descriptions of circuits, software and other related information in this document are provided for illustrative purposes in semiconductor product operation and application examples. The incorporation of these circuits, software and information in the design of a customer's equipment shall be done under the full responsibility of the customer. NEC Electronics assumes no responsibility for any losses incurred by customers or third parties arising from the use of these circuits, software and information.

- While NEC Electronics endeavors to enhance the quality, reliability and safety of NEC Electronics products, customers agree and acknowledge that the possibility of defects thereof cannot be eliminated entirely. To minimize risks of damage to property or injury (including death) to persons arising from defects in NEC Electronics products, customers must incorporate sufficient safety measures in their design, such as redundancy, fire-containment and anti-failure features.

- NEC Electronics products are classified into the following three quality grades: "Standard", "Special" and "Specific".

The "Specific" quality grade applies only to NEC Electronics products developed based on a customer-designated "quality assurance program" for a specific application. The recommended applications of an NEC Electronics product depend on its quality grade, as indicated below. Customers must check the quality grade of each NEC Electronics product before using it in a particular application.

"Standard": Computers, office equipment, communications equipment, test and measurement equipment, audio and visual equipment, home electronic appliances, machine tools, personal electronic equipment and industrial robots.

"Special": Transportation equipment (automobiles, trains, ships, etc.), traffic control systems, anti-disaster systems, anti-crime systems, safety equipment and medical equipment (not specifically designed for life support).

"Specific": Aircraft, aerospace equipment, submersible repeaters, nuclear reactor control systems, life support systems and medical equipment for life support, etc.

The quality grade of NEC Electronics products is "Standard" unless otherwise expressly specified in NEC Electronics data sheets or data books, etc. If customers wish to use NEC Electronics products in applications not intended by NEC Electronics, they must contact an NEC Electronics sales representative in advance to determine NEC Electronics' willingness to support a given application.

(Note)

(1) "NEC Electronics" as used in this statement means NEC Electronics Corporation and also includes its majority-owned subsidiaries.

(2) "NEC Electronics products" means any product developed or manufactured by or for NEC Electronics (as defined above).