

Glass Passivated Super Fast Recovery Rectifier

SF8A01-G THRU SF8A06-G

Voltage Range 50 to 600 V

Current 8.0 Ampere

Features

- ★ Fast switching for high efficiency
- ★ Low forward voltage drop
- ★ High current capability
- ★ Low reverse leakage current
- ★ High surge current capability

Mechanical Data

- ★ Case: Molded plastic TO-220AC
- ★ Epoxy: UL 94V-0 rate flame retardant
- ★ Terminals: Solderable per MIL-STD-202 method 208
- ★ Polarity: Color band denotes cathode
- ★ Mounting position: Any
- ★ Weight: 2.03 grams

TO-220AC

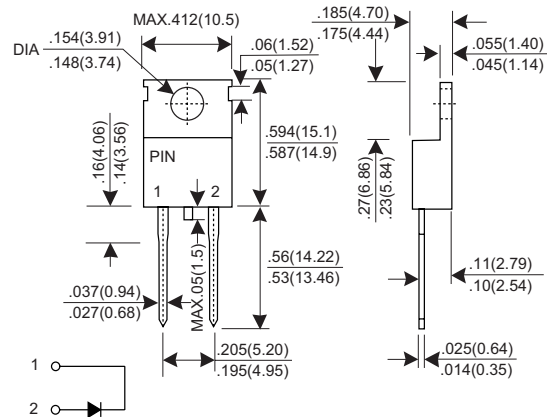

Dimensions in inches and (millimeters)

MAXIMUM RATINGS AND ELECTRICAL CHARACTERISTICS

Rating at 25°C ambient temperature unless otherwise specified.

Single phase, half wave, 60Hz, resistive or inductive load.

For capacitive load, derate current by 20%.

	SYMBOL	SF 8A01-G	SF 8A02-G	SF 8A03-G	SF 8A04-G	SF 8A05-G	SF 8A06-G	UNIT
Maximum Recurrent Peak Reverse Voltage	V _{RRM}	50	100	200	300	400	600	V
Maximum RMS Voltage	V _{RMS}	35	70	140	210	280	420	V
Maximum DC Blocking Voltage	V _{DC}	50	100	200	300	400	600	V
Maximum Average Forward Rectified Current T _c =100°C	I _{F(AV)}	8.0						A
Peak Forward Surge Current, 8.3ms single Half sine-wave superimposed on rated load (JEDEC method)	I _{FSM}	125						A
Maximum Instantaneous Forward Voltage @ 8.0 A	V _F	0.95		1.3		1.5		V
Maximum DC Reverse Current @T _J =25°C At Rated DC Blocking Voltage @T _J =125°C	I _R	10.0			250			uA uA
Maximum Reverse Recovery Time (Note 1)	T _{rr}	35			50			nS
Typical junction Capacitance (Note 2)	C _J	65						pF
Typical Thermal Resistance (Note 3)	R _{θJC}	2.2						°CW
Operating Junction and Storage Temperature Range	T _J , T _{STG}	-55 to + 150						°C

NOTES: (1) Reverse recovery test conditions I_F = 0.5A, I_R = 1.0A, I_{rr} = 0.25A.
 (2) Measured at 1.0 MHz and applied reverse voltage of 4.0 Volts DC.
 (3) Thermal Resistance junction to case.

RATINGS AND CHARACTERISTIC CURVES SF8A01-G THRU SF8A06-G

FIG.1 - FORWARD CURRENT DERATING CURVE

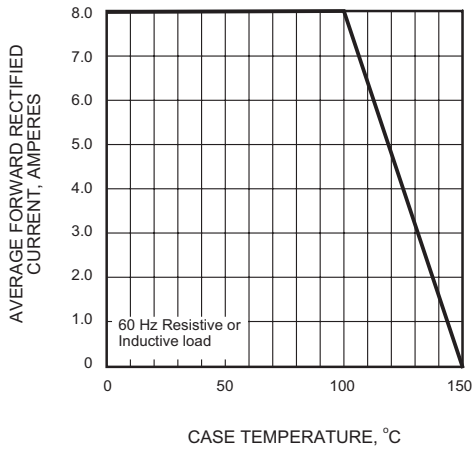

FIG.2 - MAXIMUM NON-REPETITIVE PEAK FORWARD SURGE CURRENT

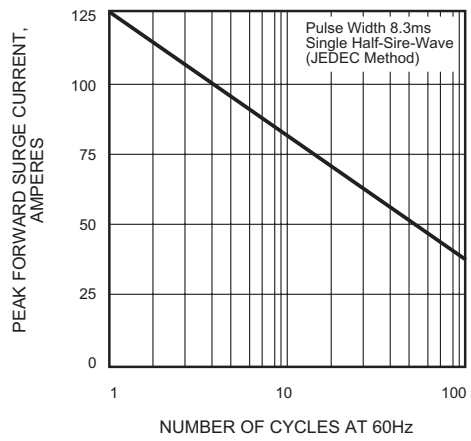

FIG.3 - TYPICAL INSTANTANEOUS FORWARD CHARACTERISTICS

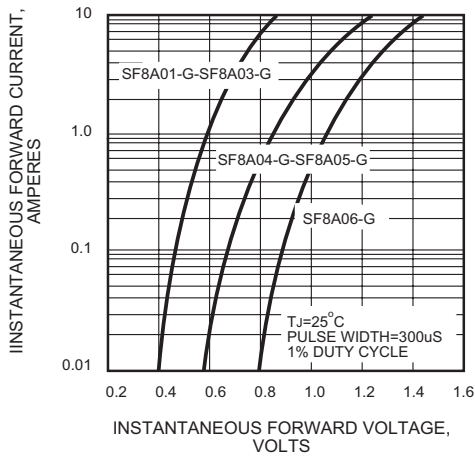

FIG.4 - TYPICAL REVERSE CHARACTERISTICS

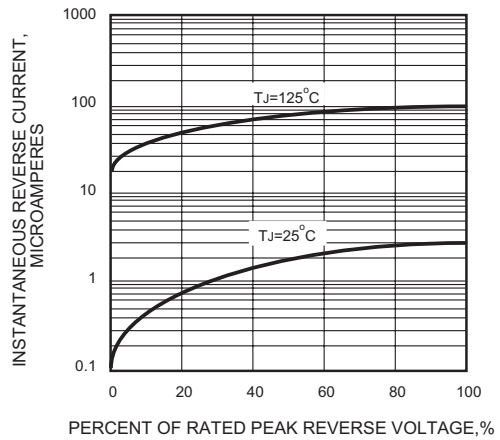

FIG.5 - TYPICAL JUNCTION CAPACITANCE

