



6-Pin DIP Zero-Cross Optoisolators Triac Driver Output (600 Volts Peak)

The MOC3061, MOC3062 and MOC3063 devices consist of gallium arsenide infrared emitting diodes optically coupled to monolithic silicon detectors performing the functions of Zero Voltage Crossing bilateral triac drivers.

They are designed for use with a triac in the interface of logic systems to equipment powered from 115/240 Vac lines, such as solid-state relays, industrial controls, motors, solenoids and consumer appliances, etc.

- Simplifies Logic Control of 115/240 Vac Power
- Zero Voltage Crossing
- dv/dt of 1500 V/ μ s Typical, 600 V/ μ s Guaranteed
- **To order devices that are tested and marked per VDE 0884 requirements, the suffix "V" must be included at end of part number. VDE 0884 is a test option.**

Recommended for 115/240 Vac(rms) Applications:

- Solenoid/Valve Controls
- Lighting Controls
- Static Power Switches
- AC Motor Drives
- Temperature Controls
- E.M. Contactors
- AC Motor Starters
- Solid State Relays

MAXIMUM RATINGS

Rating	Symbol	Value	Unit
--------	--------	-------	------

INFRARED EMITTING DIODE

Reverse Voltage	V_R	6	Volts
Forward Current — Continuous	I_F	60	mA
Total Power Dissipation @ $T_A = 25^\circ\text{C}$ Negligible Power in Output Driver Derate above 25°C	P_D	120	mW
		1.41	mW/ $^\circ\text{C}$

OUTPUT DRIVER

Off-State Output Terminal Voltage	V_{DRM}	600	Volts
Peak Repetitive Surge Current (PW = 100 μ s, 120 pps)	I_{TSM}	1	A
Total Power Dissipation @ $T_A = 25^\circ\text{C}$ Derate above 25°C	P_D	150	mW
		1.76	mW/ $^\circ\text{C}$

TOTAL DEVICE

Isolation Surge Voltage ⁽¹⁾ (Peak ac Voltage, 60 Hz, 1 Second Duration)	V_{ISO}	7500	Vac(pk)
Total Power Dissipation @ $T_A = 25^\circ\text{C}$ Derate above 25°C	P_D	250	mW
		2.94	mW/ $^\circ\text{C}$
Junction Temperature Range	T_J	-40 to +100	$^\circ\text{C}$
Ambient Operating Temperature Range	T_A	-40 to +85	$^\circ\text{C}$
Storage Temperature Range	T_{stg}	-40 to +150	$^\circ\text{C}$
Soldering Temperature (10 s)	T_L	260	$^\circ\text{C}$

1. Isolation surge voltage, V_{ISO} , is an internal device dielectric breakdown rating. For this test, Pins 1 and 2 are common, and Pins 4, 5 and 6 are common.

MOC3061
MOC3062
MOC3063

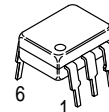

STANDARD THRU HOLE

COUPLER SCHEMATIC

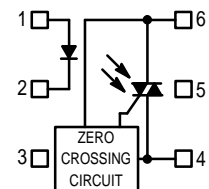

1. ANODE
2. CATHODE
3. NC
4. MAIN TERMINAL
5. SUBSTRATE
DO NOT CONNECT
6. MAIN TERMINAL

ELECTRICAL CHARACTERISTICS ($T_A = 25^\circ\text{C}$ unless otherwise noted)

Characteristic	Symbol	Min	Typ	Max	Unit
INPUT LED					
Reverse Leakage Current ($V_R = 6\text{ V}$)	I_R	—	0.05	100	μA
Forward Voltage ($I_F = 30\text{ mA}$)	V_F	—	1.3	1.5	Volts
OUTPUT DETECTOR ($I_F = 0$)					
Leakage with LED Off, Either Direction (Rated $V_{DRM}^{(1)}$)	I_{DRM1}	—	60	500	nA
Critical Rate of Rise of Off-State Voltage ⁽³⁾	dv/dt	600	1500	—	V/ μs
COUPLED					
LED Trigger Current, Current Required to Latch Output (Main Terminal Voltage = $3\text{ V}^{(2)}$)	I_{FT}	—	—	15 10 5	mA
					MOC3061 MOC3062 MOC3063
Peak On-State Voltage, Either Direction ($I_{TM} = 100\text{ mA}$, $I_F = \text{Rated } I_{FT}$)	V_{TM}	—	1.8	3	Volts
Holding Current, Either Direction	I_H	—	250	—	μA
Inhibit Voltage (MT1–MT2 Voltage above which device will not trigger.) ($I_F = \text{Rated } I_{FT}$)	V_{INH}	—	5	20	Volts
Leakage in Inhibited State ($I_F = \text{Rated } I_{FT}$, Rated V_{DRM} , Off State)	I_{DRM2}	—	—	500	μA
Isolation Voltage ($f = 60\text{ Hz}$, $t = 1\text{ sec}$)	V_{ISO}	7500	—	—	Vac(pk)

1. Test voltage must be applied within dv/dt rating.
2. All devices are guaranteed to trigger at an I_F value less than or equal to max I_{FT} . Therefore, recommended operating I_F lies between max I_{FT} (15 mA for MOC3061, 10 mA for MOC3062, 5 mA for MOC3063) and absolute max I_F (60 mA).
3. This is static dv/dt. See Figure 7 for test circuit. Commutating dv/dt is a function of the load-driving thyristor(s) only.

TYPICAL CHARACTERISTICS

$T_A = 25^\circ\text{C}$

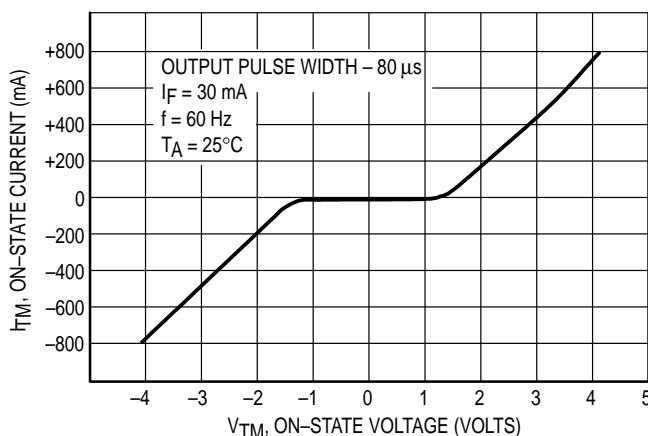

Figure 1. On-State Characteristics

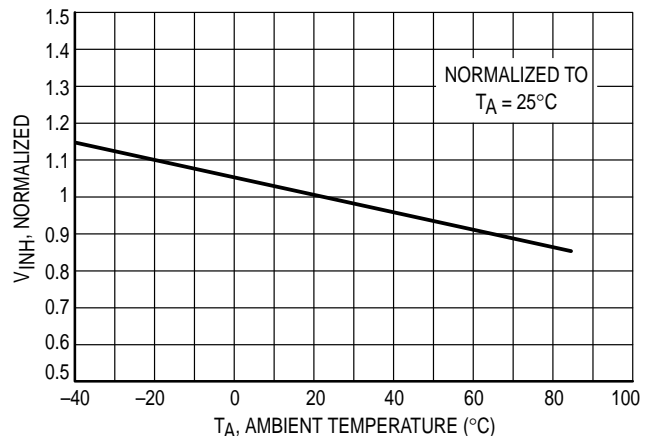

Figure 2. Inhibit Voltage versus Temperature

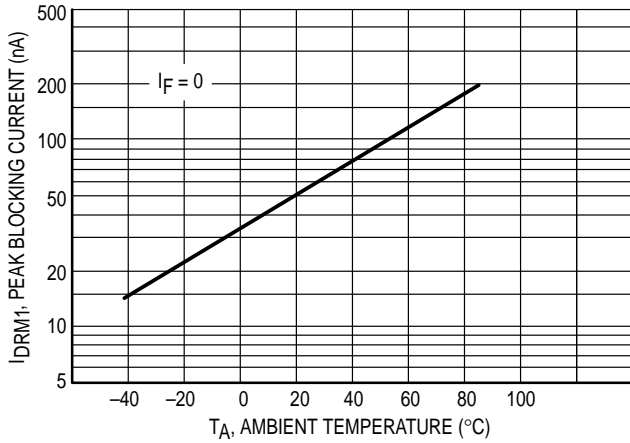

Figure 3. Leakage with LED Off versus Temperature

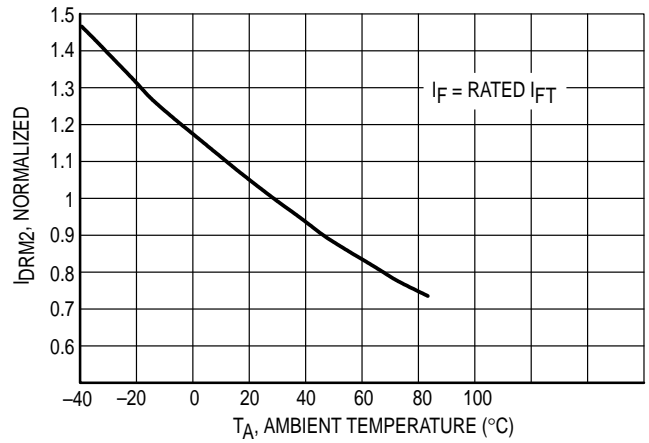

Figure 4. IDRM2, Leakage in Inhibit State versus Temperature

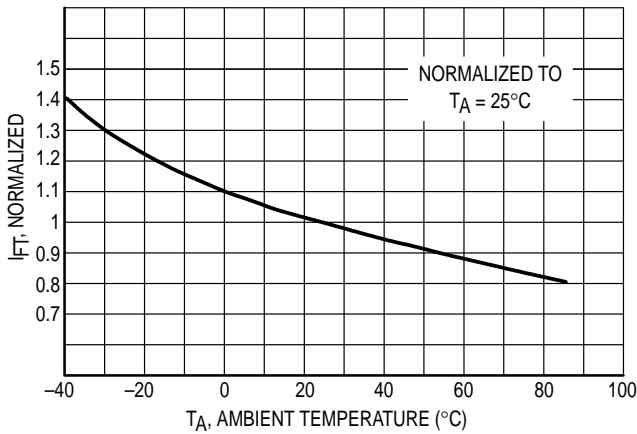

Figure 5. Trigger Current versus Temperature

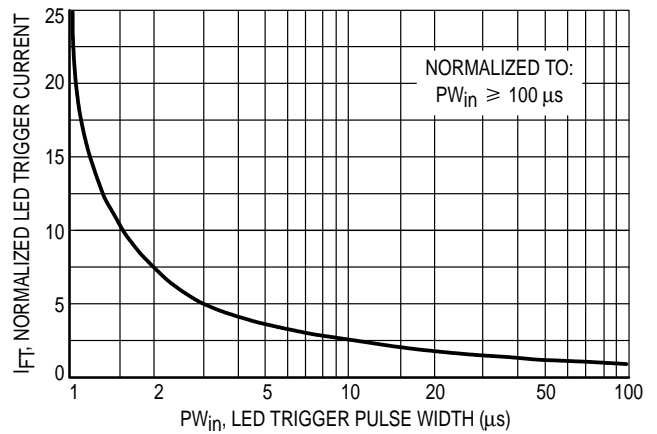
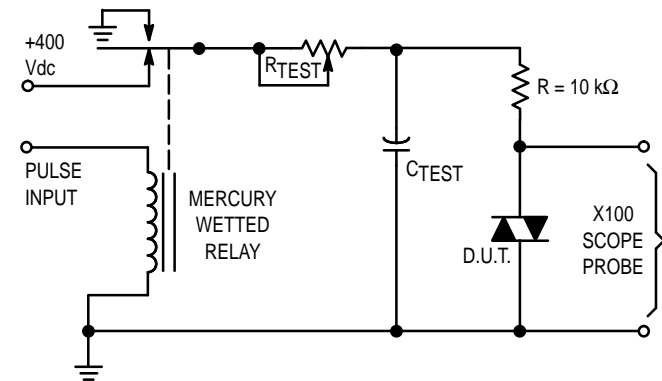

Figure 6. LED Current Required to Trigger versus LED Pulse Width



1. The mercury wetted relay provides a high speed repeated pulse to the D.U.T.
2. 100x scope probes are used, to allow high speeds and voltages.
3. The worst-case condition for static dv/dt is established by triggering the D.U.T. with a normal LED input current, then removing the current. The variable R_{TEST} allows the dv/dt to be gradually increased until the D.U.T. continues to trigger in response to the applied voltage pulse, even after the LED current has been removed. The dv/dt is then decreased until the D.U.T. stops triggering. τ_{RC} is measured at this point and recorded.

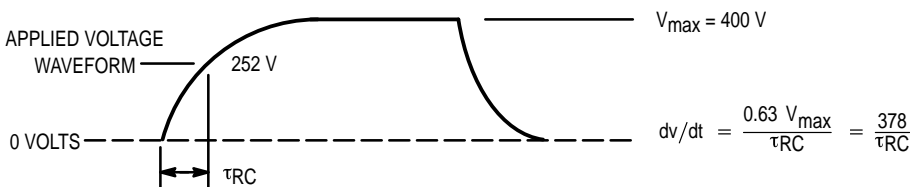
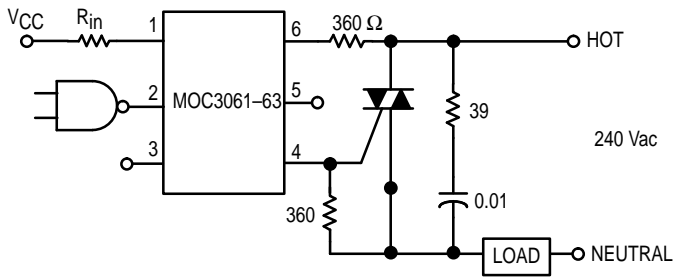

Figure 7. Static dv/dt Test Circuit



Typical circuit for use when hot line switching is required. In this circuit the "hot" side of the line is switched and the load connected to the cold or neutral side. The load may be connected to either the neutral or hot line.

R_{in} is calculated so that I_F is equal to the rated I_{FT} of the part, 15 mA for the MOC3061, 10 mA for the MOC3062, and 5 mA for the MOC3063. The 39 ohm resistor and 0.01 μ F capacitor are for snubbing of the triac and may or may not be necessary depending upon the particular triac and load used.

Figure 8. Hot-Line Switching Application Circuit

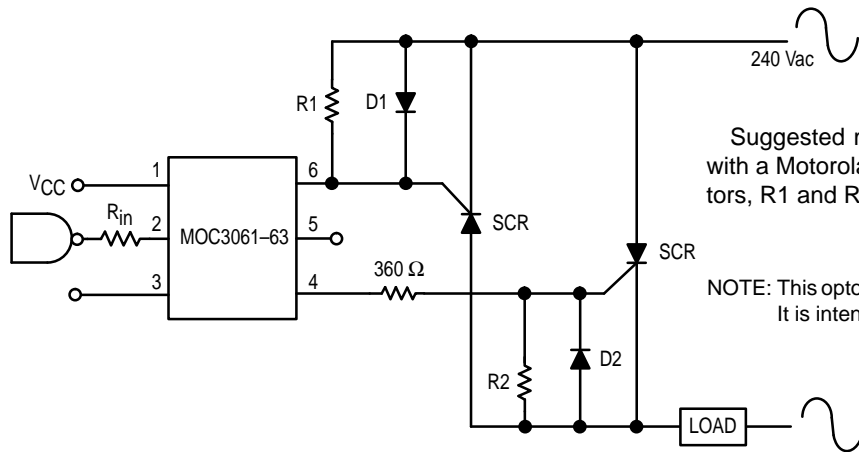

Suggested method of firing two, back-to-back SCR's, with a Motorola triac driver. Diodes can be 1N4001; resistors, R1 and R2, are optional 330 ohms.

NOTE: This optoisolator should not be used to drive a load directly. It is intended to be a trigger device only.

Figure 9. Inverse-Parallel SCR Driver Circuit

PACKAGE DIMENSIONS

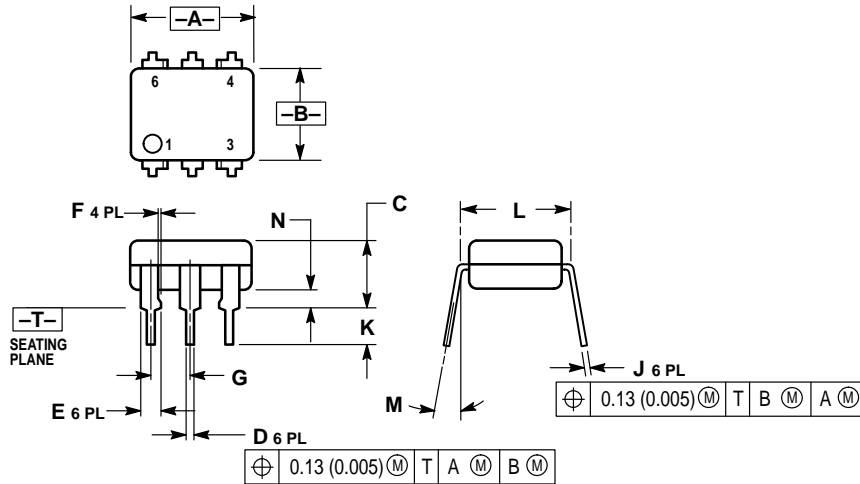

- NOTES:
1. DIMENSIONING AND TOLERANCING PER ANSI Y14.5M, 1982.
2. CONTROLLING DIMENSION: INCH.
3. DIMENSION L TO CENTER OF LEAD WHEN FORMED PARALLEL.

DIM	INCHES		MILLIMETERS	
	MIN	MAX	MIN	MAX
A	0.320	0.350	8.13	8.89
B	0.240	0.260	6.10	6.60
C	0.115	0.200	2.93	5.08
D	0.016	0.020	0.41	0.50
E	0.040	0.070	1.02	1.77
F	0.010	0.014	0.25	0.36
G	0.100 BSC		2.54 BSC	
J	0.008	0.012	0.21	0.30
K	0.100	0.150	2.54	3.81
L	0.300 BSC		7.62 BSC	
M	0°	15°	0°	15°
N	0.015	0.100	0.38	2.54

- STYLE 6:
PIN 1: ANODE
2: CATHODE
3: NC
4: MAIN TERMINAL
5: SUBSTRATE
6: MAIN TERMINAL

THRU HOLE

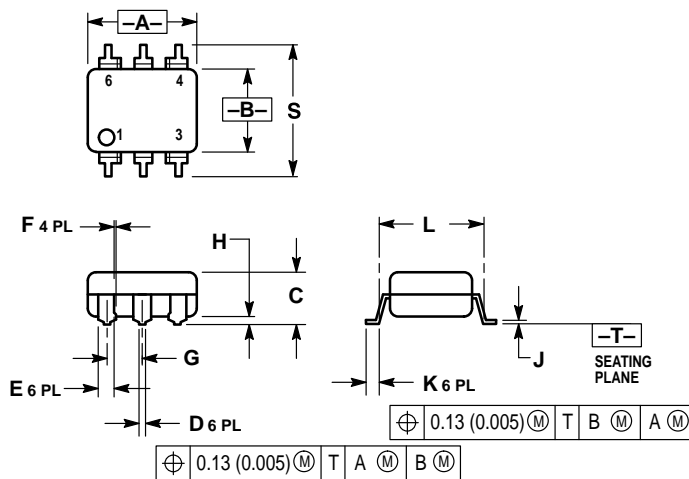

- NOTES:
1. DIMENSIONING AND TOLERANCING PER ANSI Y14.5M, 1982.
2. CONTROLLING DIMENSION: INCH.

DIM	INCHES		MILLIMETERS	
	MIN	MAX	MIN	MAX
A	0.320	0.350	8.13	8.89
B	0.240	0.260	6.10	6.60
C	0.115	0.200	2.93	5.08
D	0.016	0.020	0.41	0.50
E	0.040	0.070	1.02	1.77
F	0.010	0.014	0.25	0.36
G	0.100 BSC		2.54 BSC	
H	0.020	0.025	0.51	0.63
J	0.008	0.012	0.20	0.30
K	0.006	0.035	0.16	0.88
L	0.320 BSC		8.13 BSC	
S	0.332	0.390	8.43	9.90

SURFACE MOUNT

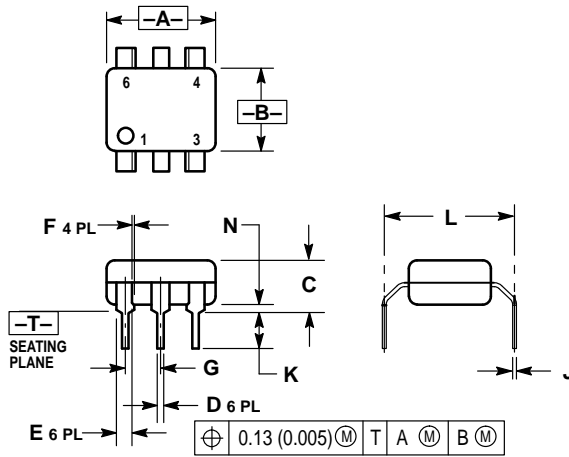

NOTES:

1. DIMENSIONING AND TOLERANCING PER ANSI Y14.5M, 1982.
2. CONTROLLING DIMENSION: INCH.
3. DIMENSION L TO CENTER OF LEAD WHEN FORMED PARALLEL.

DIM	INCHES		MILLIMETERS	
	MIN	MAX	MIN	MAX
A	0.320	0.350	8.13	8.89
B	0.240	0.260	6.10	6.60
C	0.115	0.200	2.93	5.08
D	0.016	0.020	0.41	0.50
E	0.040	0.070	1.02	1.77
F	0.010	0.014	0.25	0.36
G	0.100 BSC		2.54 BSC	
J	0.008	0.012	0.21	0.30
K	0.100	0.150	2.54	3.81
L	0.400	0.425	10.16	10.80
N	0.015	0.040	0.38	1.02

0.4" LEAD SPACING

DISCLAIMER

FAIRCHILD SEMICONDUCTOR RESERVES THE RIGHT TO MAKE CHANGES WITHOUT FURTHER NOTICE TO ANY PRODUCTS HEREIN TO IMPROVE RELIABILITY, FUNCTION OR DESIGN. FAIRCHILD DOES NOT ASSUME ANY LIABILITY ARISING OUT OF THE APPLICATION OR USE OF ANY PRODUCT OR CIRCUIT DESCRIBED HEREIN; NEITHER DOES IT CONVEY ANY LICENSE UNDER ITS PATENT RIGHTS, NOR THE RIGHTS OF OTHERS.

LIFE SUPPORT POLICY

FAIRCHILD'S PRODUCTS ARE NOT AUTHORIZED FOR USE AS CRITICAL COMPONENTS IN LIFE SUPPORT DEVICES OR SYSTEMS WITHOUT THE EXPRESS WRITTEN APPROVAL OF THE PRESIDENT OF FAIRCHILD SEMICONDUCTOR CORPORATION. As used herein:

1. Life support devices or systems are devices or systems which, (a) are intended for surgical implant into the body, or (b) support or sustain life, and (c) whose failure to perform when properly used in accordance with instructions for use provided in the labeling, can be reasonably expected to result in a significant injury of the user.
2. A critical component in any component of a life support device or system whose failure to perform can be reasonably expected to cause the failure of the life support device or system, or to affect its safety or effectiveness.