

Broadband CATV 2-Way Active Splitter with default loop-thru Switch 50 - 1100 MHz

Rev. V1

Features

- Always ON loop-thru path
- 2-Way Splitter
- 4.0 dB Gain
- +15 dBmV /Channel Input
- 4.5 dB Noise Figure
- Single 5 Volt Supply
- Lead-Free 3 mm 12-Lead PQFN Package
- RoHS* Compliant and 260°C Reflow Compatible

Description

The MAAM-009879 CATV 2-way active splitter with the default loop-thru path is a GaAs MMIC which exhibits low noise figure and distortion in a lead-free 3mm 12-lead PQFN plastic package. The design features 75 Ω inputs and outputs.

The MAAM-009879 is ideally suited for multi-tuner set top boxes, home gateways, and other broadband internet based applications.

The MAAM-009879 is fabricated using M/A-COM Technology's E/D pHEMT process to realize default loop-thru operation, low noise and low distortion. The process features full passivation for robust performance and reliability.

Functional Schematic, Default On, Power Off

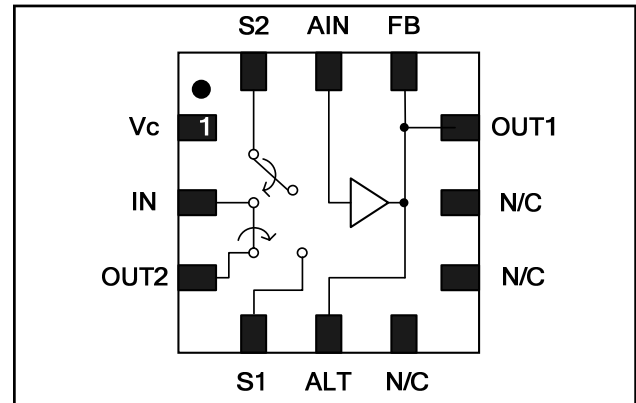

Functional Schematic, Power On

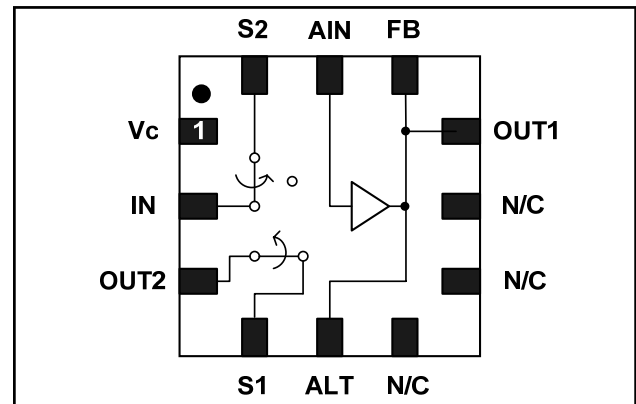

Pin Configuration³

Pin No.	Pin Name	Description
1	V _c	Voltage Control
2	IN	RF Input
3	OUT2	RF Output 2
4	S1	Switch Loop thru In
5	ALT	Alternate Output
6	N/C	No Connection
7	N/C	No Connection
8	N/C	No Connection
9	OUT1	RF Output 1
10	FB	Amplifier Feedback
11	AIN	Amplifier Input
12	S2	Switch Output
13	Paddle	RF and DC Ground

3. The exposed pad centered on the package bottom must be connected to RF and DC ground.

Ordering Information^{1,2}

Part Number	Package
MAAM-009879-TR1000	1000 piece reel
MAAM-009879-TR3000	3000 piece reel
MAAM-009879-001SMB	Sample Test Board

1. Reference Application Note M513 for reel size information.
2. All sample boards include 5 loose parts.

* Restrictions on Hazardous Substances, European Union Directive 2002/95/EC.

Broadband CATV 2-Way Active Splitter with default loop-thru Switch 50 - 1100 MHz

Rev. V1

Electrical Specifications: Freq. = 1000 MHz, $T_A = 25^\circ\text{C}$, $Z_0 = 75 \Omega$

Parameter	Test Conditions	V _{DD}	V _C	Units	Min.	Typ.	Max.
Gain	In to Out1 or 2	5	3.3	dB	3.0	4.0	5.0
Insertion Loss	In to Out2	0	0	dB	-	0.6	0.8
Noise Figure	In to Out1 or 2	5	3.3	dB	-	4.5	-
Gain Flatness	In to Out1 or 2	5	3.3	dB	-	1.5	-
Input Return Loss	Input	5	3.3	dB	-	12	-
Input Return Loss	Input	0	0	dB	-	14	-
Output Return Loss	Out1 or 2	5	3.3	dB	-	13	-
Output Return Loss	Out2	0	0	dB	-	15	-
Out to Out Isolation	Out1 to Out2	5	3.3	dB	-	22	-
Out to Out Isolation	Out1 to Out2	0	0	dB	-	45	-
CTB	132 Ch, +15 dBmV/Ch at the Input	5	3.3	dBc	-	-65	-
CSO	132 Ch, +15 dBmV/Ch at the Input	5	3.3	dBc	-	-60	-
Reverse Isolation	Out1 to In	5	3.3	dB	-	30	-
Reverse Isolation	Out2 to In	5	3.3	dB	-	23	-
Reverse Isolation	Out1 to In	0	0	dB	-	45	-
OIP2	500 MHz, 2-tone, 6 MHz spacing, -10 dBm Pout	5	3.3/0	dBm	-	42	-
OIP3	500 MHz, 2-tone, 6 MHz spacing, -10 dBm Pout	5	3.3/0	dBm	-	22	-
P1dB	500 MHz	5	3.3	dBm	-	6	-
P1dB	500 MHz	5	0	dBm	-	15	-
I _{DD}		5	3.3	mA	80	100	110
I _C		5	3.3	μA	-	200	250

4. The unpowered state is the same as V_{control} = 0V

Absolute Maximum Ratings^{5,6,7}

Parameter	Absolute Maximum
Max Input Power	+5 dBm
V _{DD}	+10.0 V
V _{CONTROL}	+8.5 V
Operating Temperature	-40°C to +85°C
Junction Temperature ⁸	+150°C
Storage Temperature	-65°C to +150°C

- Exceeding any one or combination of these limits may cause permanent damage to this device.
- M/A-COM Technology does not recommend sustained operation near these survivability limits.
- These operating conditions will ensure MTTF > 1 x 10⁶ hours.
- Junction Temperature (T_J) = T_A + Θ_{JC} * (V * I)
Typical thermal resistance (Θ_{JC}) = 73 °C/W.
 - For T_A = 25°C,
T_J = 66 °C @ 5.0 V, 110 mA
 - For T_A = 85°C,
T_J = 122 °C @ 5.0 V, 100 mA

Schematic Including Off-Chip Components⁹

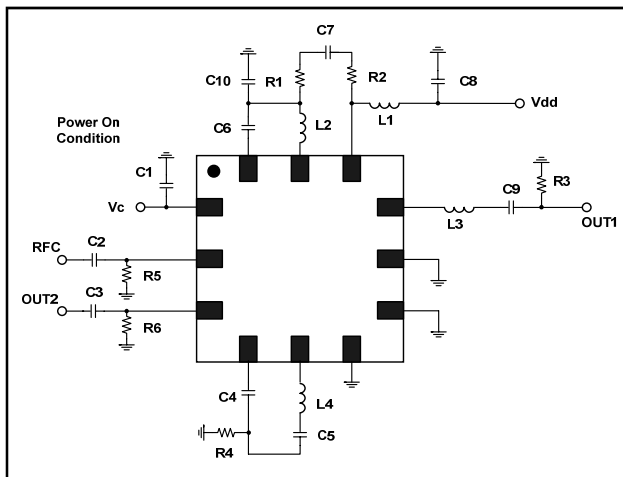

- The exposed pad centered on the package bottom must be connected to ground for RF, DC and thermal considerations.

Truth Table¹⁰

V _{DD}	V _{CONTROL}	IN - OUT1	IN - OUT2
1	1	On	On
0	0	Off	On

10. Logic "1" for V_{DD} = +5 volts and V_{CONTROL} = +3.3 volts typical.

Handling Procedures

Please observe the following precautions to avoid damage:

Static Sensitivity

Gallium Arsenide Integrated Circuits are sensitive to electrostatic discharge (ESD) and can be damaged by static electricity. Proper ESD control techniques should be used when handling these devices. An external protection circuit using an inexpensive anti-parallel diode pair can be used to protect the IC.

Please reference application note AN3028 on <http://www.macomtech.com> for further detail.

Recommended PCB

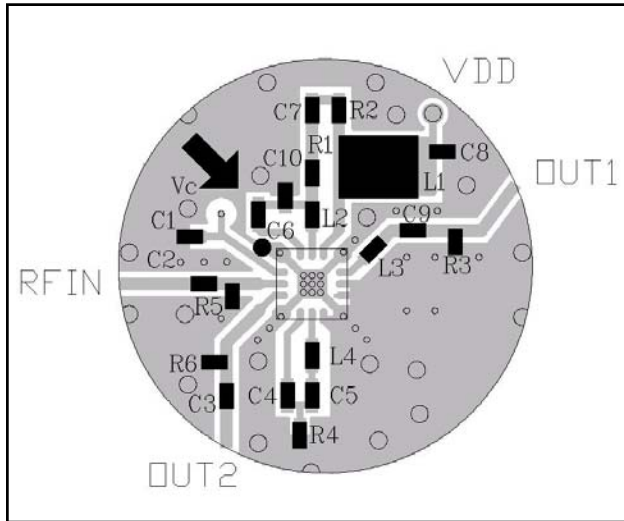

PCB Land Pattern

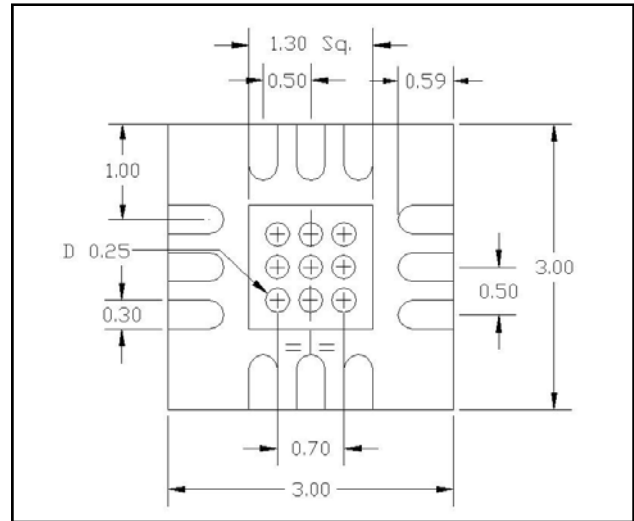

Block Diagram RF Signal Flow

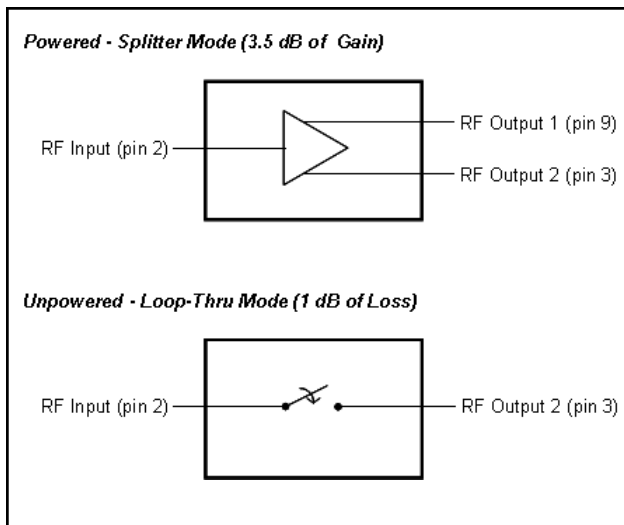

Off-Chip Component Values

Component	Value	Package
C1 - C9	0.01 μ F	0402
C10	1.0 pF	0402
L1 ¹¹	1 μ H	1210
R1, R2	300 Ω	0402
R3	130 Ω	0402
R4	180 Ω	0402
R5, R6	22 k Ω	0402
L2 - L4	7.5 nH	0402

11. L1 supplied from EPCOS, part number B82422A1102K100

Typical Performance Curves

Gain

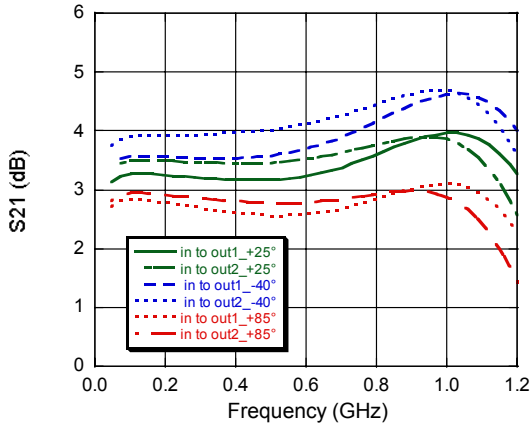

Gain to 3 GHz

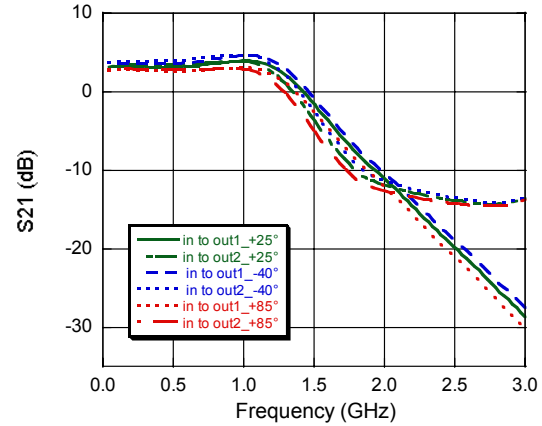

Input Return Loss (power on)

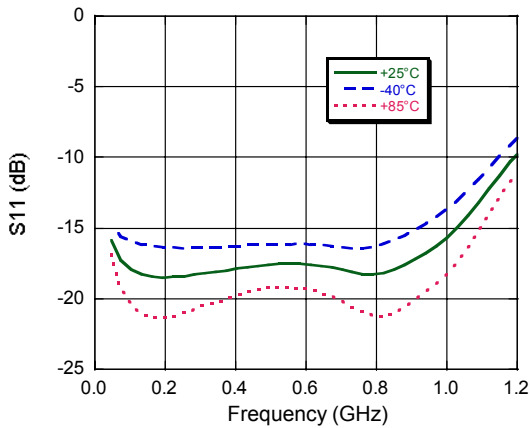

Input Return Loss (power off)

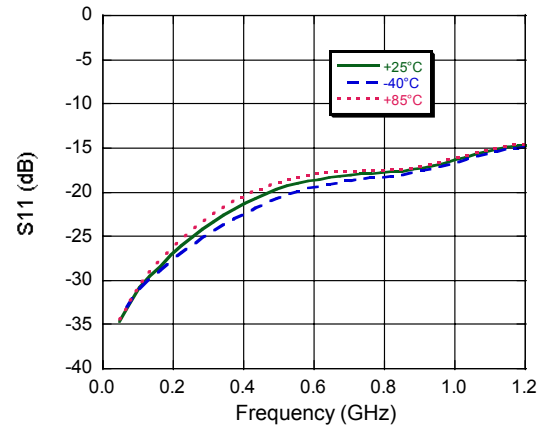

Output Return Loss (power on)

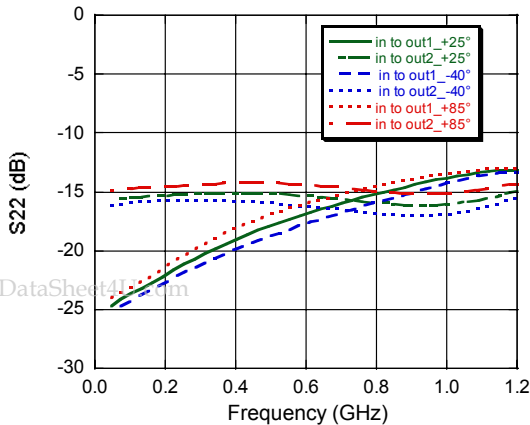

Output Return Loss (power off)

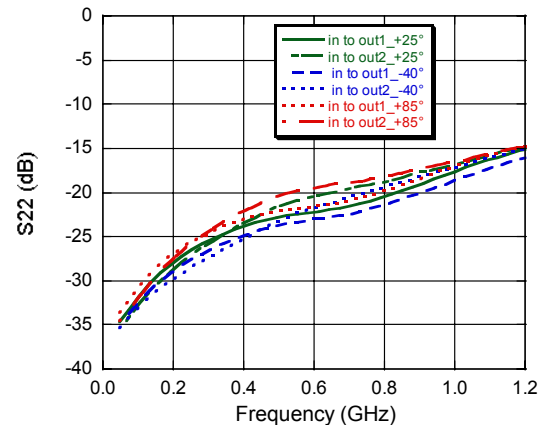

Typical Performance Curves

Insertion Loss to 1 GHz (power off)

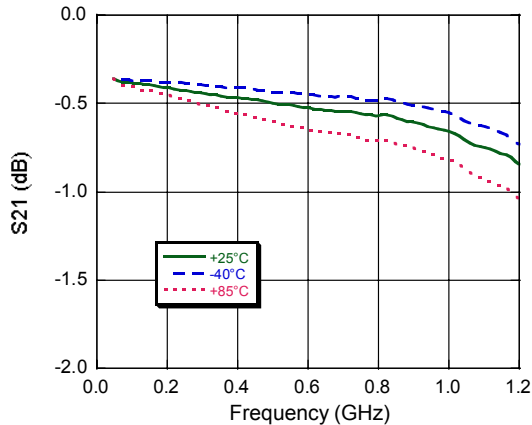

Insertion Loss to 3 GHz (power off)

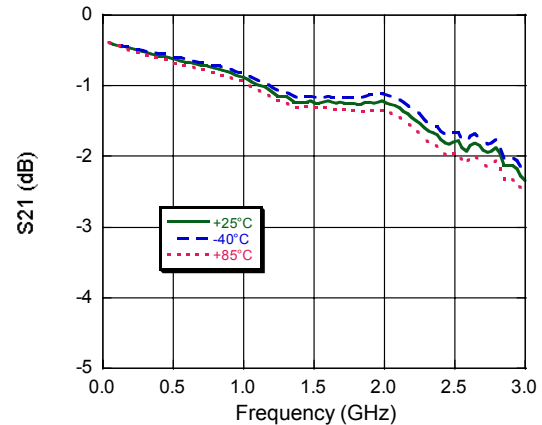

Reverse Isolation to 3 GHz (power on)

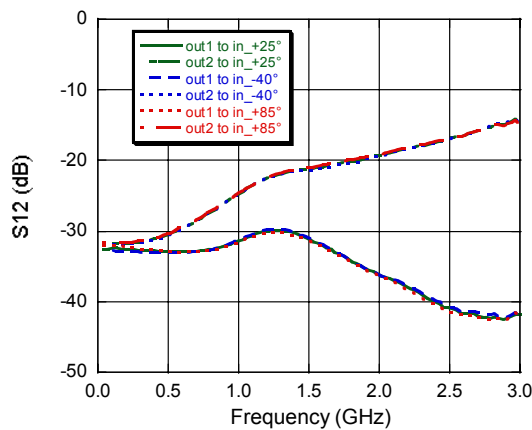

Reverse Isolation to 3 GHz (power off)

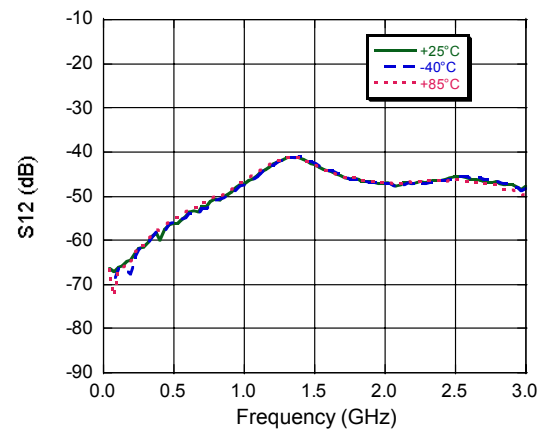

Noise Figure

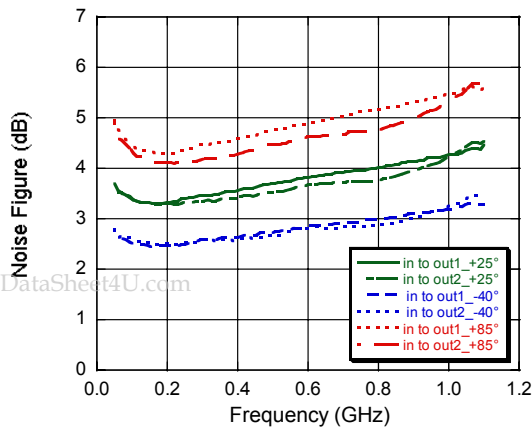

Typical Performance Curves

Out to Out Isolation to 1 GHz (power on)

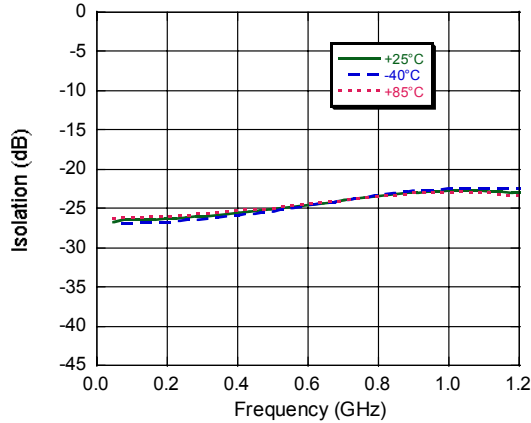

Out to Out Isolation to 3 GHz (power on)

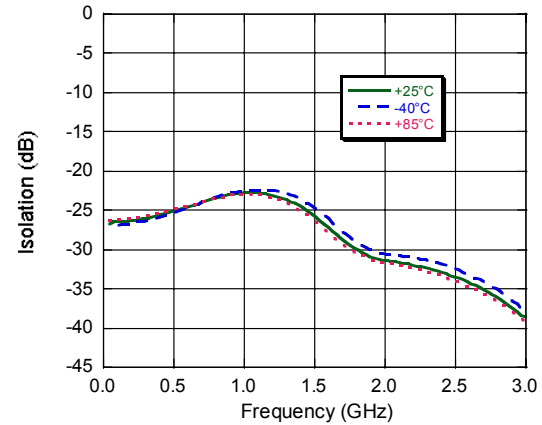

Out to Out Isolation to 1 GHz (power off)

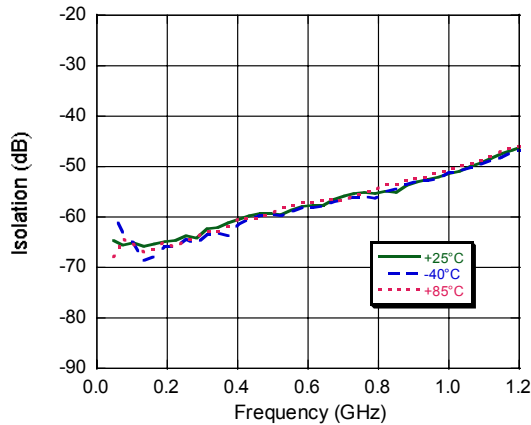

Out to Out Isolation to 3 GHz (power off)

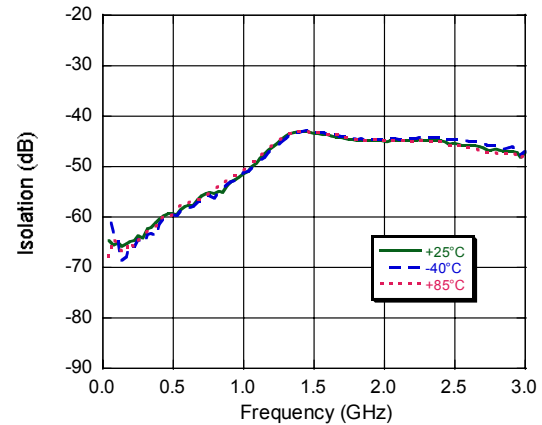

Lead-Free 3 mm 12-Lead PQFN†

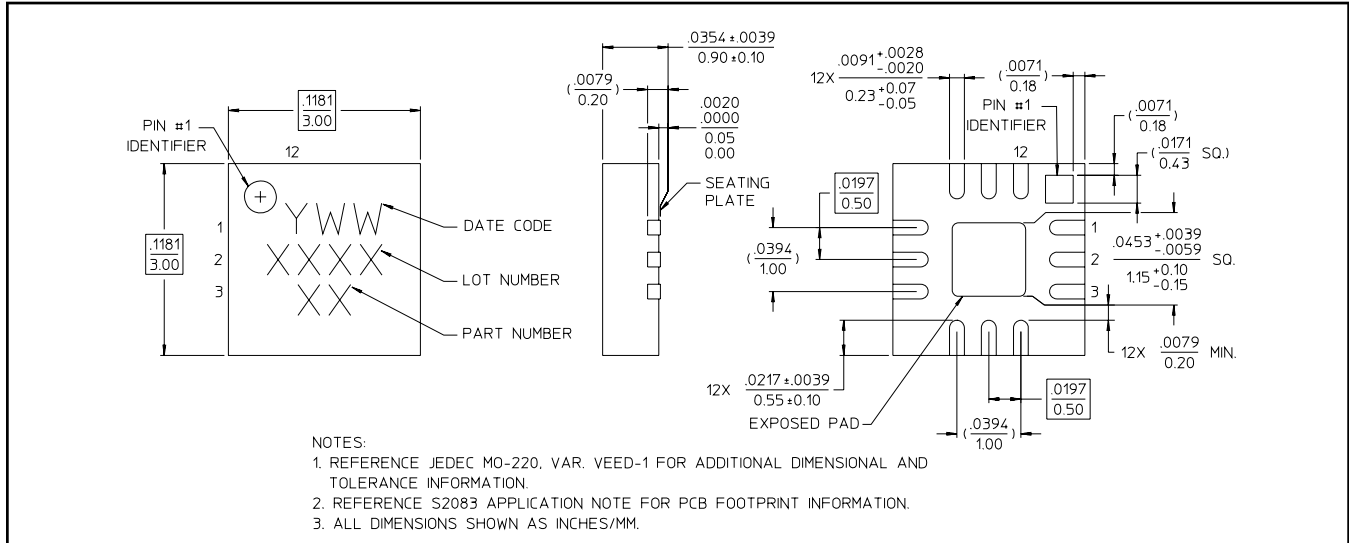

† Reference Application Note S2083 for lead-free solder reflow recommendations.
 Meets JEDEC moisture sensitivity level 1 requirements.
 Plating is 100% matte tin over copper.