

# Opto-Switch

## EE-SX1025

### Transmissive

- Phototransistor output.
- 5.4-mm-tall low profile model.
- PCB mounting type.
- High resolution with a 0.5-mm-wide aperture.
- 2.8mm slot width.
- Off-centre location pip for correct orientation.

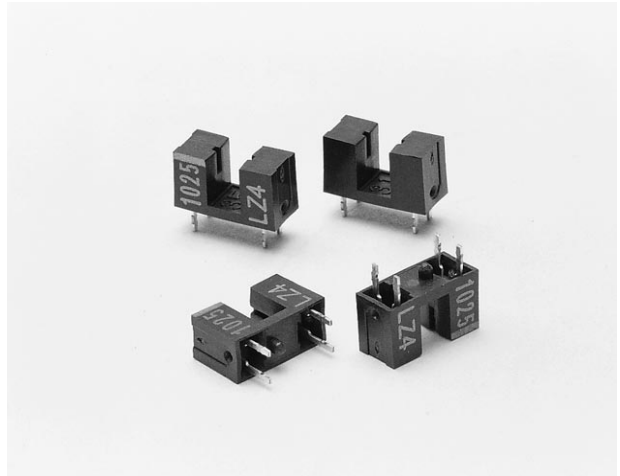

### Dimensions

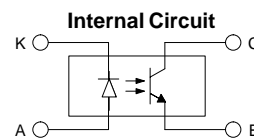
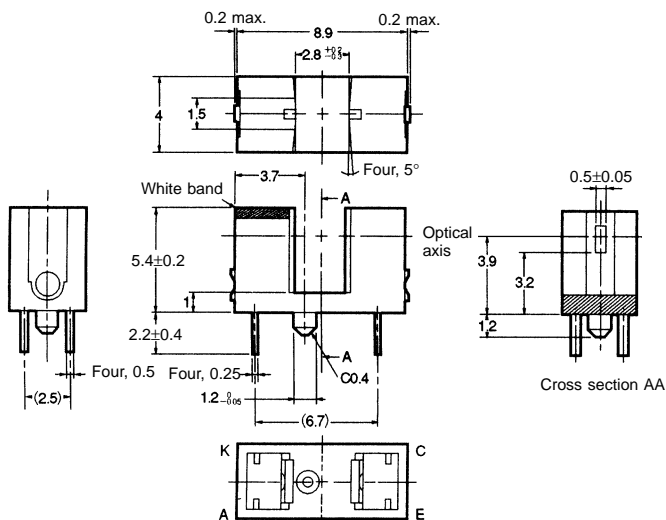

Terminal No.	Name
A	Anode
K	Cathode
C	Collector
E	Emitter

Unless otherwise specified, the tolerances are as shown below.

Dimensions	Tolerance
3 mm max.	±0.3
3 < mm ≤ 6	±0.375
6 < mm ≤ 10	±0.45
10 < mm ≤ 18	±0.55
18 < mm ≤ 30	±0.65

### Specifications

#### ■ Absolute Maximum Ratings (Ta = 25°C)

Item	Symbol	Rated value	
Emitter	Forward current	$I_F$	50 mA (see note 1)
	Pulse forward current	$I_{FP}$	1 A (see note 2)
	Reverse voltage	$V_R$	4 V
Detector	Collector-Emitter voltage	$V_{CEO}$	30 V
	Emitter-Collector voltage	$V_{ECO}$	---
	Collector current	$I_C$	20 mA
	Collector dissipation	$P_C$	100 mW (see note 1)
Ambient temperature	Operating	$T_{opr}$	-25°C to 85°C
	Storage	$T_{stg}$	-30°C to 100°C
	Soldering	$T_{sol}$	260°C

- Note:**
1. Refer to the temperature rating chart if the ambient temperature exceeds 25°C.
  2. The pulse width is 10  $\mu$ s maximum with a frequency of 100 Hz.

## ■ Electrical and Optical Characteristics (Ta = 25°C)

Item		Symbol	Value	Condition
Emitter	Forward voltage	$V_F$	1.2 V typ., 1.5 V max.	$I_F = 30$ mA
	Reverse current	$I_R$	0.01 $\mu$ A typ., 10 $\mu$ A max.	$V_R = 4$ V
	Peak emission wavelength	$\lambda_P$	940 nm typ.	$I_F = 20$ mA
Detector	Light current	$I_L$	0.5 mA min., 14 mA max.	$I_F = 20$ mA, $V_{CE} = 10$ V
	Dark current	$I_D$	2 nA typ., 200 nA max.	$V_{CE} = 10$ V, 0 lx
	Leakage current	$I_{LEAK}$	---	---
	Collector–Emitter saturated voltage	$V_{CE(sat)}$	0.1 V typ., 0.4 V max.	$I_F = 20$ mA, $I_L = 0.1$ mA
	Peak spectral sensitivity wavelength	$\lambda_P$	850 nm typ.	$V_{CE} = 10$ V
Rising time		$t_r$	4 $\mu$ s typ.	$V_{CC} = 5$ V, $R_L = 100 \Omega$ , $I_L = 5$ mA
Falling time		$t_f$	4 $\mu$ s typ.	$V_{CC} = 5$ V, $R_L = 100 \Omega$ , $I_L = 5$ mA

## Engineering Data

**Forward Current vs. Collector Dissipation Temperature Rating**

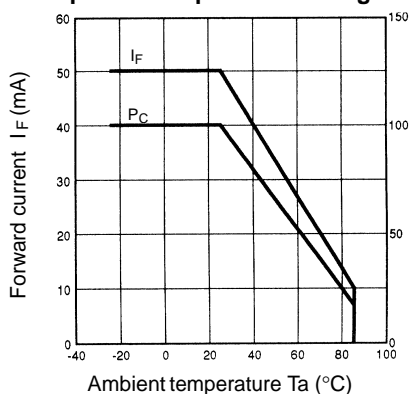

**Forward Current vs. Forward Voltage Characteristics (Typical)**

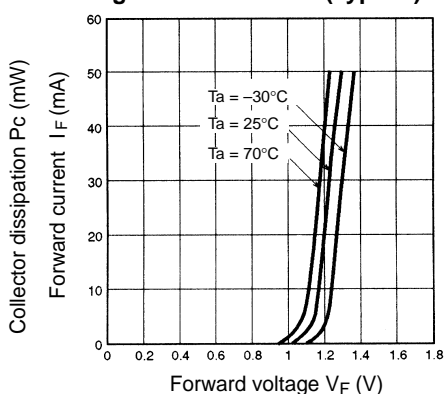

**Light Current vs. Forward Current Characteristics (Typical)**

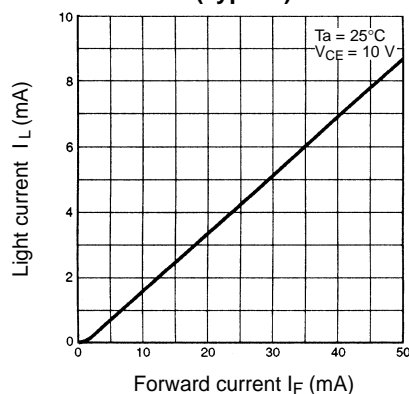

**Light Current vs. Collector–Emitter Voltage Characteristics (Typical)**

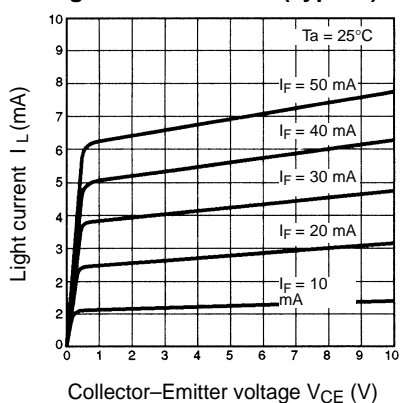

**Relative Light Current vs. Ambient Temperature Characteristics (Typical)**

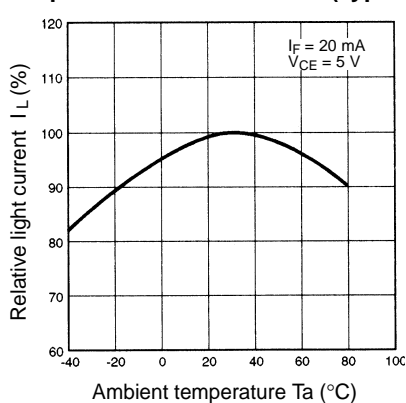

**Dark Current vs. Ambient Temperature Characteristics (Typical)**

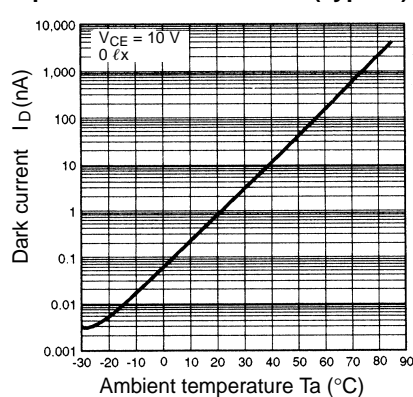

**Response Time vs. Load Resistance Characteristics (Typical)**

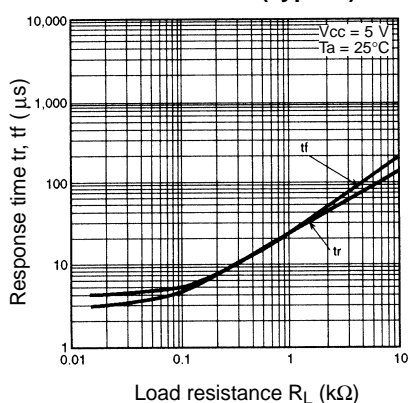

**Sensing Position Characteristics (Typical)**

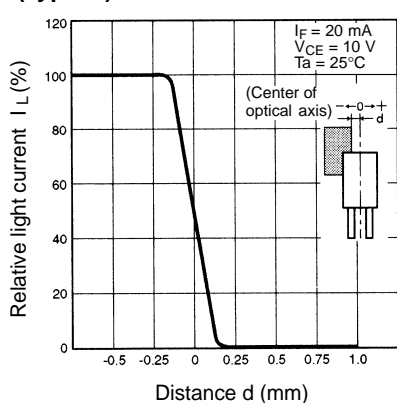

**Response Time Measurement Circuit**

