

DATA SHEET

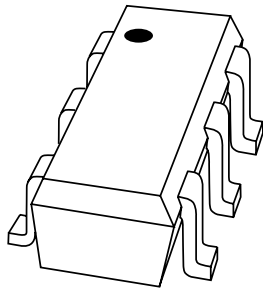

www.DataSheet4U.com

PESD3V3L5UY; PESD5V0L5UY
Low capacitance 5-fold ESD
protection diode arrays in SOT363
package

Product specification

2004 Mar 23

Low capacitance 5-fold ESD protection diode arrays in SOT363 package

PESD3V3L5UY; PESD5V0L5UY

FEATURES

- Uni-directional ESD protection of up to five lines
- Bi-directional ESD protection of up to four lines
- Low diode capacitance
- Maximum peak pulse power: $P_{pp} = 25 \text{ W}$ at $t_p = 8/20 \mu\text{s}$
- Low clamping voltage: $V_{CL(R)} = 12 \text{ V}$ at $I_{pp} = 2.5 \text{ A}$
- Ultra low leakage current: $I_{RM} = 8 \text{ nA}$ at $V_{RWM} = 5 \text{ V}$
- ESD protection > 20 kV
- IEC 61000-4-2; level 4 (ESD)
- IEC 61000-4-5 (surge); $I_{pp} = 2.5 \text{ A}$ at $T_p = 8/20 \mu\text{s}$.

APPLICATIONS

- Cellular handsets and accessories
- Portable electronics
- Computers and peripherals
- Communications systems
- Audio and video equipment.

DESCRIPTION

Low capacitance 5-fold ESD protection array in the very small SOT363 plastic package designed to protect up to five transmission or data lines from the damage caused by Electrostatic Discharge (ESD).

MARKING

TYPE NUMBER	MARKING CODE ⁽¹⁾
PESD3V3L5UY	*K3
PESD5V0L5UY	*K4

Note

- * = p: Made in Hong Kong.
* = t: Made in Malaysia.
* = W: Made in China.

ORDERING INFORMATION

TYPE NUMBER	PACKAGE		
	NAME	DESCRIPTION	VERSION
PESD3V3L5UY	–	plastic surface mounted package; 6 leads	SOT363
PESD5V0L5UY	–	plastic surface mounted package; 6 leads	SOT363

QUICK REFERENCE DATA

SYMBOL	PARAMETER	VALUE	UNIT
V_{RWM}	reverse standoff voltage		
	PESD3V3L5UY	3.3	V
	PESD5V0L5UY	5	V
C_d	diode capacitance		
	PESD3V3L5UY	22	pF
	PESD5V0L5UY	16	pF
	number of protected lines	5	

PINNING

PIN	DESCRIPTION
1	cathode 1
2	common anode
3	cathode 2
4	cathode 3
5	cathode 4
6	cathode 5

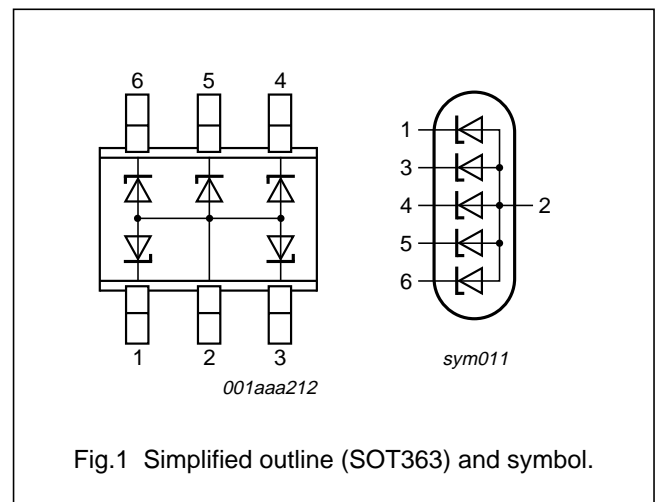

Low capacitance 5-fold ESD protection diode arrays in SOT363 package

PESD3V3L5UY;
PESD5V0L5UY

LIMITING VALUES

In accordance with the Absolute Maximum Rating System (IEC 60134).

SYMBOL	PARAMETER	CONDITIONS	MIN.	MAX.	UNIT
Per diode					
P_{pp}	peak pulse power	8/20 μ s pulse; notes 1 and 2	–	25	W
I_{pp}	peak pulse current	8/20 μ s pulse; notes 1 and 2	–	2.5	A
T_j	junction temperature		–	150	$^{\circ}$ C
T_{amb}	operating ambient temperature		–65	+150	$^{\circ}$ C
T_{stg}	storage temperature		–65	+150	$^{\circ}$ C

Notes

1. Non-repetitive current pulse 8/20 μ s exponentially decaying waveform; see Fig.2.
2. Measured from any of pins 1, 3, 4, 5 or 6 to pin 2.

ESD maximum ratings

SYMBOL	PARAMETER	CONDITIONS	VALUE	UNIT
Per diode				
ESD	electrostatic discharge capability	IEC 61000-4-2 (contact discharge); notes 1 and 2	20	kV
		HBM MIL-Std 883	10	kV

Notes

1. Device stressed with ten non-repetitive Electrostatic Discharge (ESD) pulses; see Fig.3.
2. Measured from any of pins 1, 3, 4, 5 or 6 to pin 2.

ESD standards compliance

ESD STANDARD	CONDITIONS
IEC 61000-4-2, level 4 (ESD)	> 15 kV (air); > 8 kV (contact)
HBM MIL-Std 883, class 3	> 4 kV

Low capacitance 5-fold ESD protection diode arrays in SOT363 package

PESD3V3L5UY;
PESD5V0L5UY

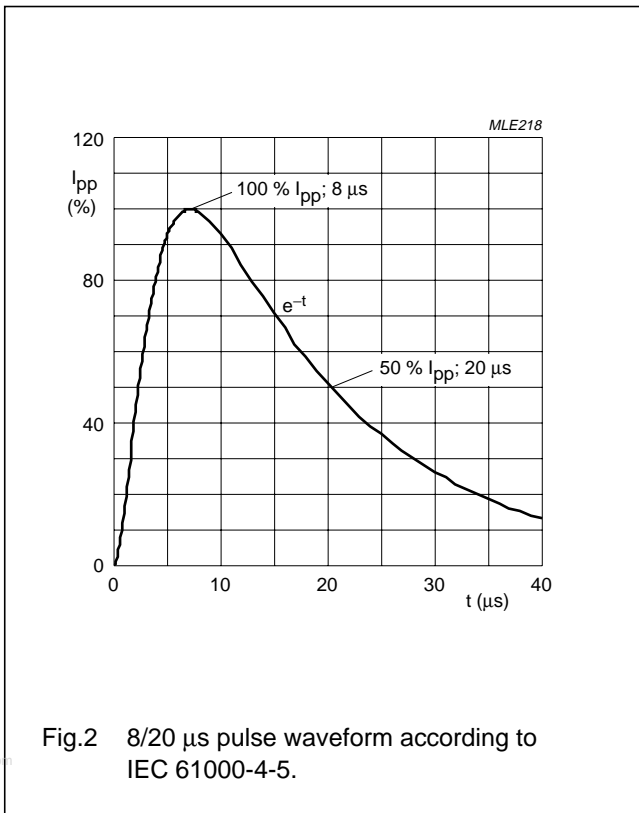

Fig.2 8/20 μ s pulse waveform according to IEC 61000-4-5.

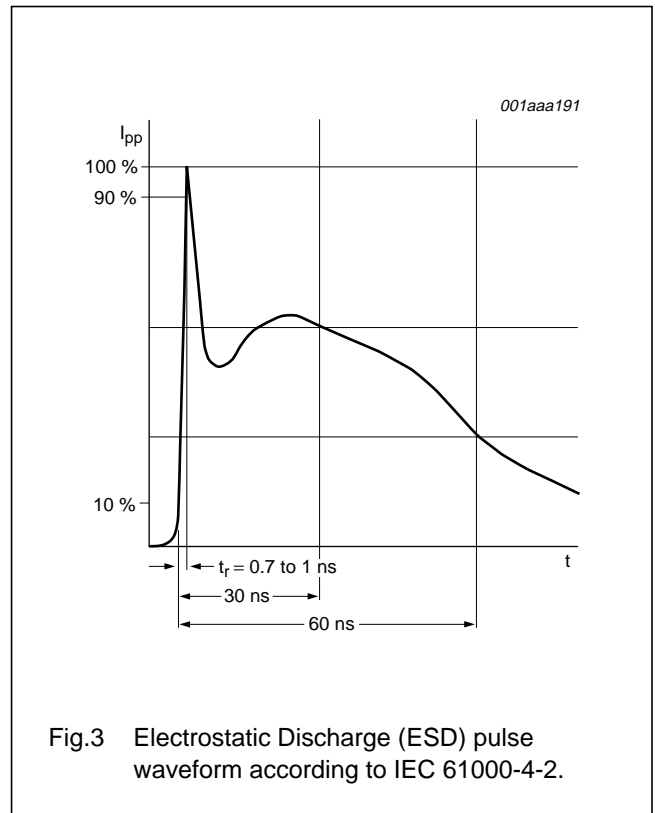

Fig.3 Electrostatic Discharge (ESD) pulse waveform according to IEC 61000-4-2.

Low capacitance 5-fold ESD protection diode arrays in SOT363 package

PESD3V3L5UY;
PESD5V0L5UY

CHARACTERISTICS

$T_j = 25\text{ °C}$ unless otherwise specified.

SYMBOL	PARAMETER	CONDITIONS	MIN.	TYP.	MAX.	UNIT
Per diode						
V_{RWM}	reverse stand-off voltage					
	PESD3V3L5UY		–	–	3.3	V
	PESD5V0L5UY		–	–	5	V
I_{RM}	reverse leakage current					
	PESD3V3L5UY	$V_{RWM} = 3.3\text{ V}$	–	75	300	nA
	PESD5V0L5UY	$V_{RWM} = 5\text{ V}$	–	5	25	nA
V_{BR}	breakdown voltage	$I_Z = 1\text{ mA}$				
	PESD3V3L5UY		5.3	5.6	5.9	V
	PESD5V0L5UY		6.4	6.8	7.2	V
C_d	diode capacitance	$f = 1\text{ MHz}; V_R = 0\text{ V};$ see Fig.5				
	PESD3V3L5UY		–	22	28	pF
	PESD5V0L5UY		–	16	19	pF
$V_{CL(R)}$	clamping voltage	notes 1 and 2				
	PESD3V3L5UY	$I_{pp} = 1\text{ A}$	–	–	10	V
		$I_{pp} = 2.5\text{ A}$	–	–	12	V
	PESD5V0L5UY	$I_{pp} = 1\text{ A}$	–	–	10	V
		$I_{pp} = 2.5\text{ A}$	–	–	12	V
r_{diff}	differential resistance	$I_R = 1\text{ mA}$				
	PESD3V3L5UY		–	–	200	Ω
	PESD5V0L5UY		–	–	100	Ω

Notes

1. Non-repetitive current pulse 8/20 μs exponentially decaying waveform; see Fig.2.
2. Measured from any of pins 1, 3, 4, 5 or 6 to pin 2.

Low capacitance 5-fold ESD protection diode arrays in SOT363 package

PESD3V3L5UY;
PESD5V0L5UY

GRAPHICAL DATA

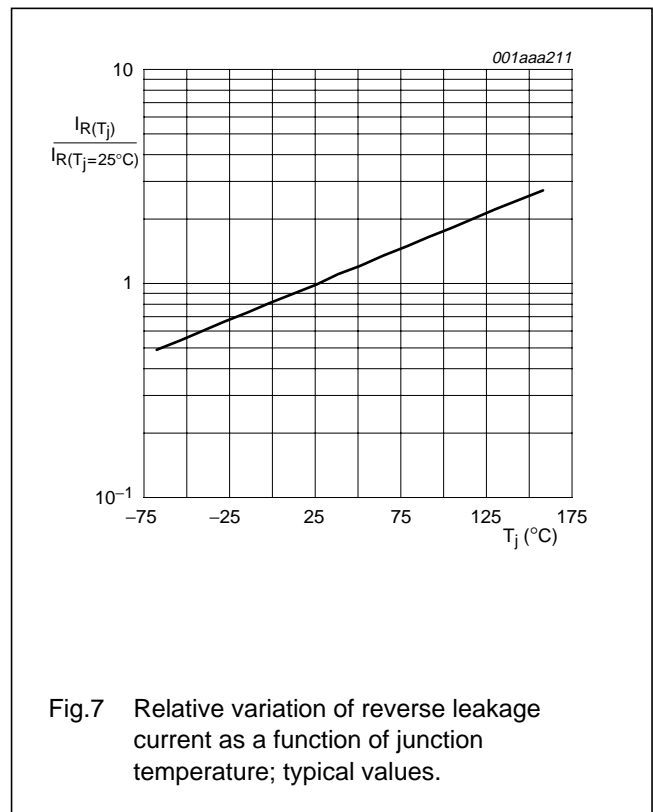
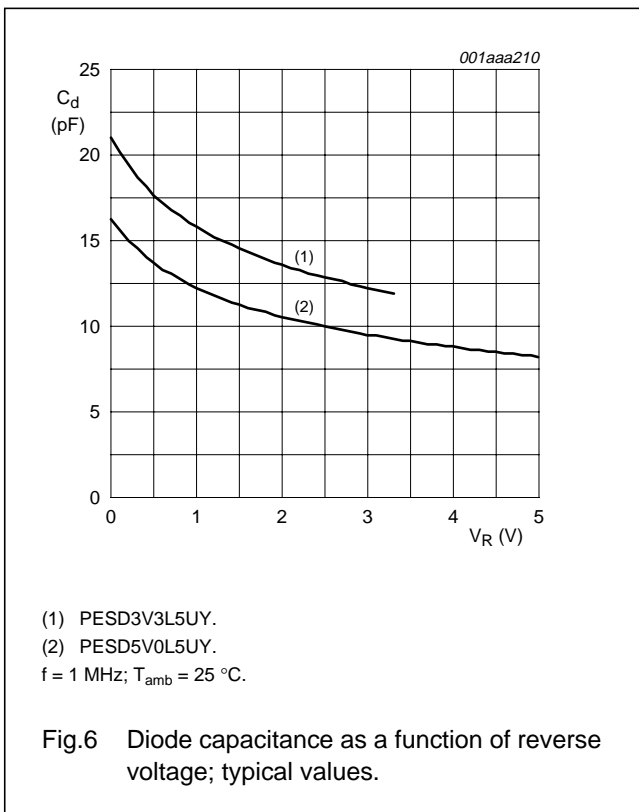
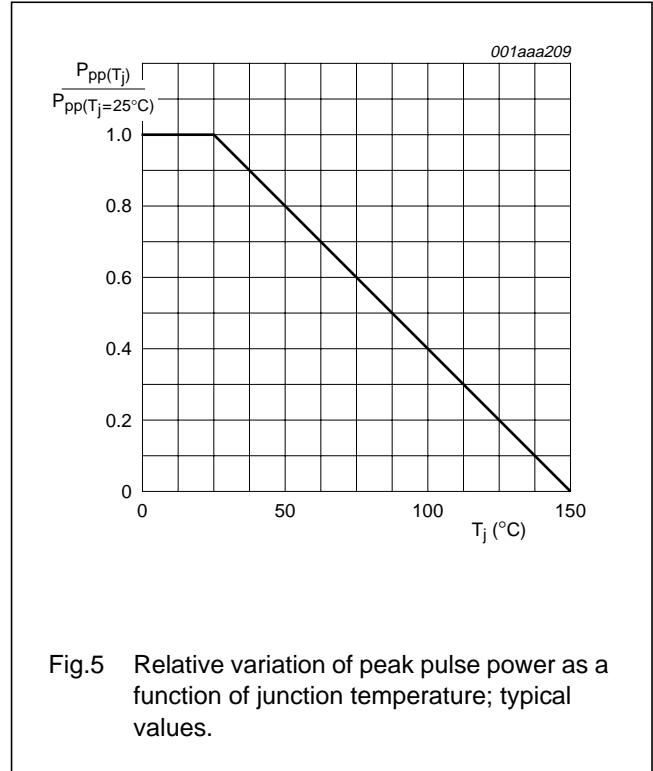
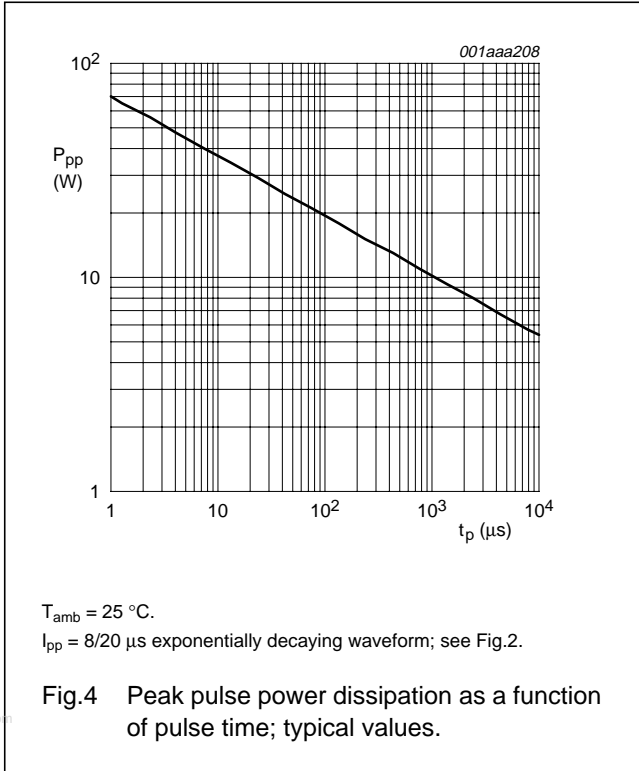

Low capacitance 5-fold ESD protection diode arrays in SOT363 package

PESD3V3L5UY; PESD5V0L5UY

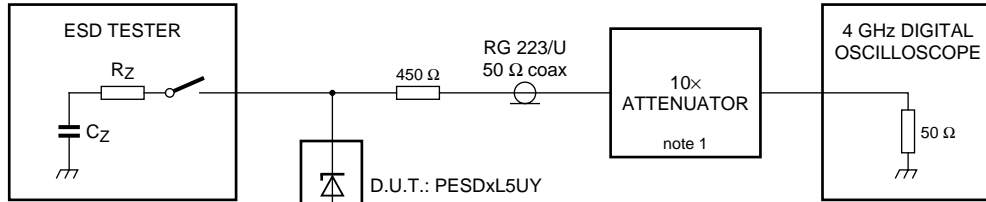

Note 1: Attenuator is only used for open socket high voltage measurements

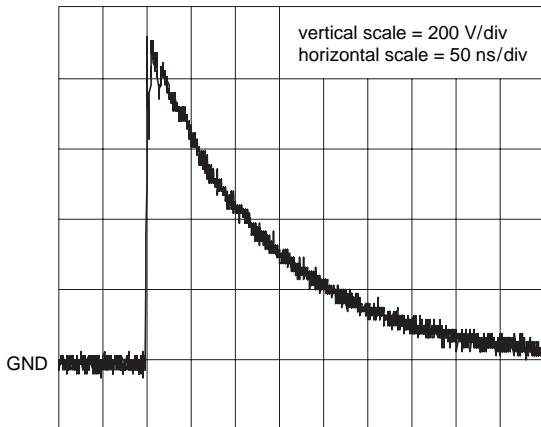

unclamped +1 kV ESD voltage waveform (IEC61000-4-2 network)

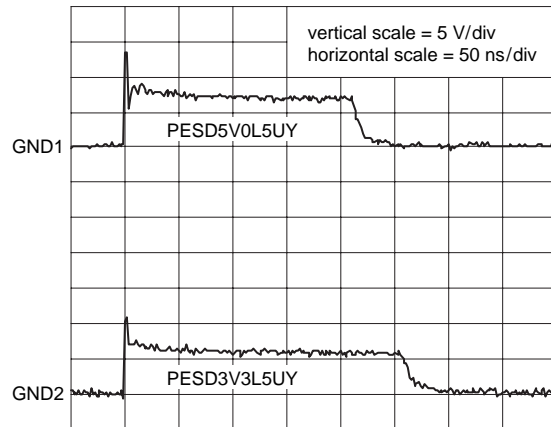

clamped +1 kV ESD voltage waveform (IEC61000-4-2 network)

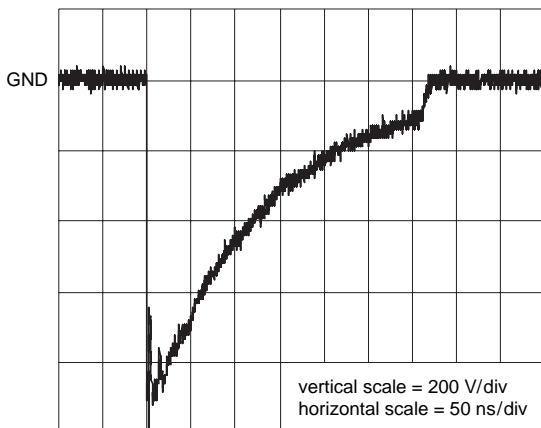

unclamped -1 kV ESD voltage waveform (IEC61000-4-2 network)

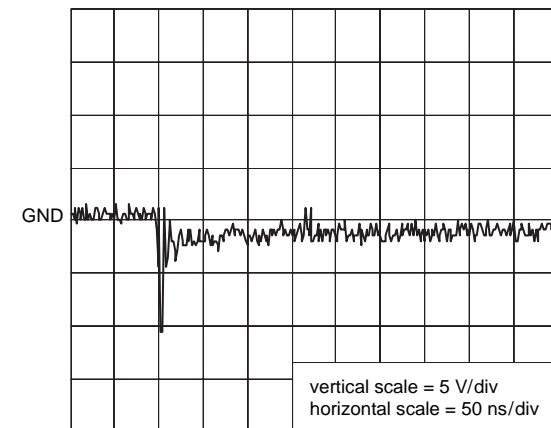

clamped -1 kV ESD voltage waveform (IEC61000-4-2 network)

001aaa218

Fig.8 ESD clamping test set-up and waveforms.

Low capacitance 5-fold ESD protection diode arrays in SOT363 package

PESD3V3L5UY;
PESD5V0L5UY

APPLICATION INFORMATION

The PESDxL5UY is designed for the uni-directional protection of up to five lines or bi-directional protection of four lines from the damage caused by Electrostatic Discharge (ESD) and surge pulses. The PESDxL5UY may be used on lines where the signal polarities are above or below ground. PESDxL5UY can withstand and provides protection from a surge of 25 watts peak pulse power per line for a 8/20 μ s waveform.

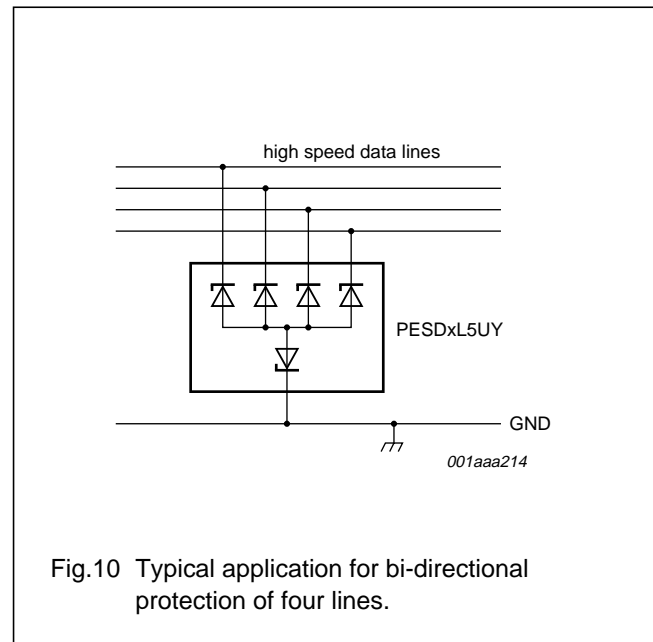
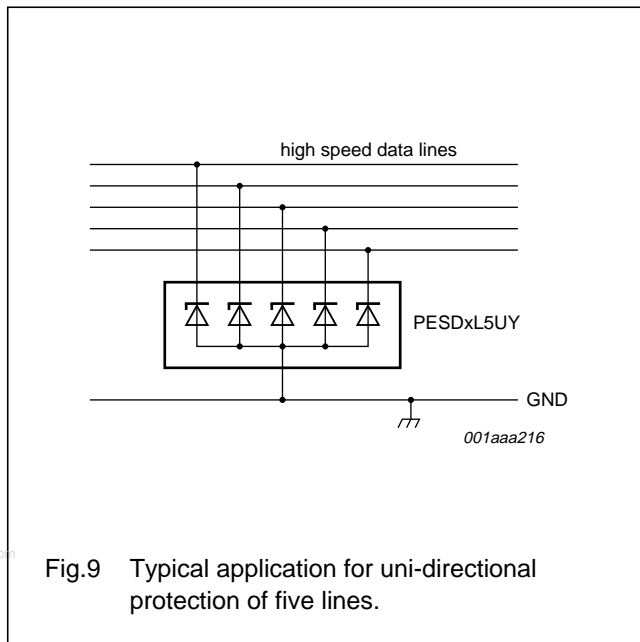

Circuit board layout and protection device placement

Circuit board layout is critical for the suppression of ESD, Electrical Fast Transient (EFT) and surge transients. The following guidelines are recommended:

1. The protection device should be placed as closely as possible to the input terminal or connector.
2. The path length between the protection device and the protected line should be as short as possible.
3. Parallel signal paths should be kept to a minimum.
4. Running protection conductors in parallel with unprotected conductor should be avoided.
5. All printed-circuit board conductive loops (including power and group loops) should be kept to a minimum.
6. The length of the transient return path to ground should be kept to a minimum.
7. The use of shared transient return paths to a common ground point should be avoided.
8. Ground planes should be used whenever possible.
9. For multilayer printed-circuit boards, ground vias should be used.

Low capacitance 5-fold ESD protection diode arrays in SOT363 package

PESD3V3L5UY;
PESD5V0L5UY

PACKAGE OUTLINE

Plastic surface mounted package; 6 leads

SOT363

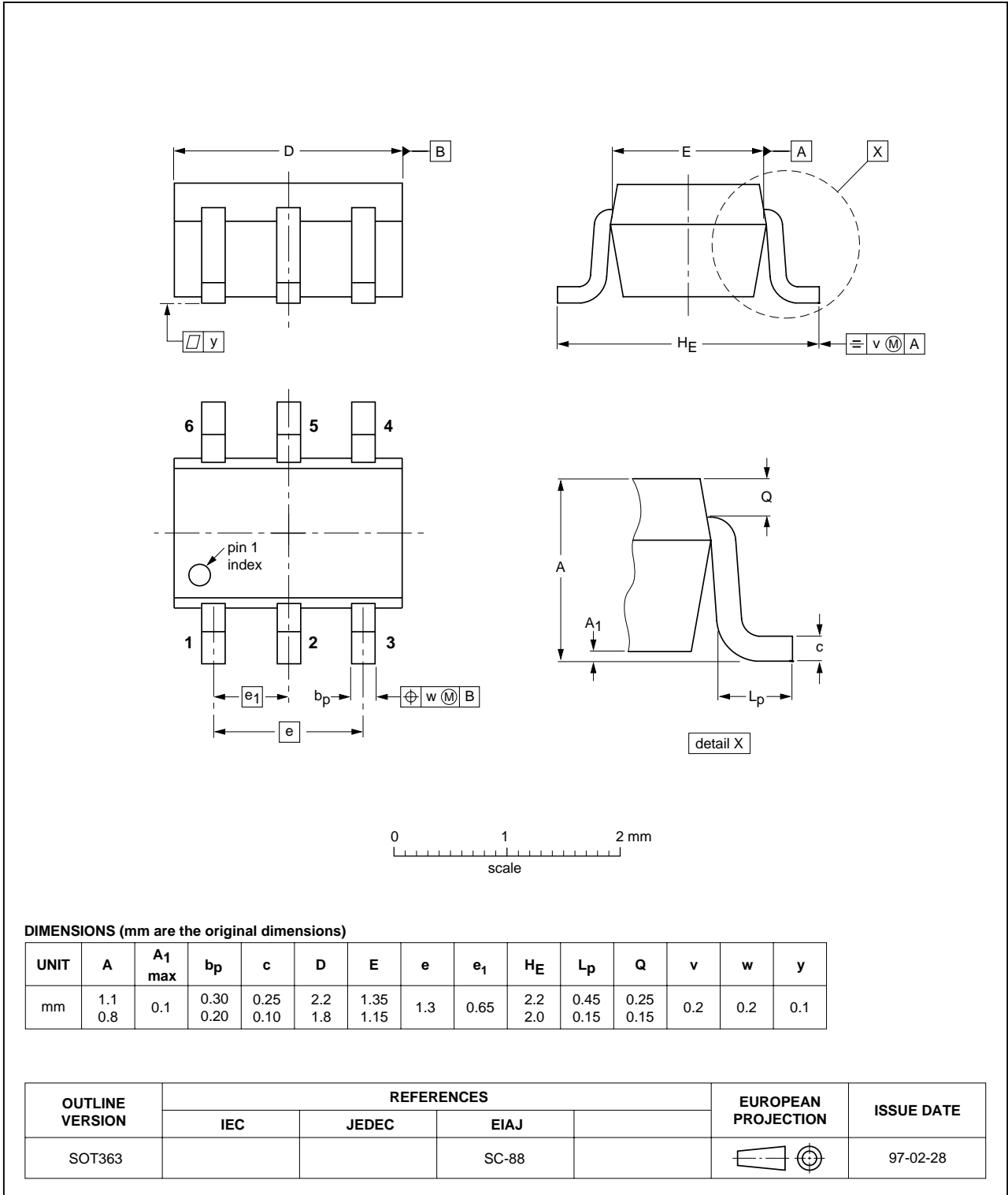

Low capacitance 5-fold ESD protection diode arrays in SOT363 package

PESD3V3L5UY;
PESD5V0L5UY

DATA SHEET STATUS

LEVEL	DATA SHEET STATUS ⁽¹⁾	PRODUCT STATUS ⁽²⁾⁽³⁾	DEFINITION
I	Objective data	Development	This data sheet contains data from the objective specification for product development. Philips Semiconductors reserves the right to change the specification in any manner without notice.
II	Preliminary data	Qualification	This data sheet contains data from the preliminary specification. Supplementary data will be published at a later date. Philips Semiconductors reserves the right to change the specification without notice, in order to improve the design and supply the best possible product.
III	Product data	Production	This data sheet contains data from the product specification. Philips Semiconductors reserves the right to make changes at any time in order to improve the design, manufacturing and supply. Relevant changes will be communicated via a Customer Product/Process Change Notification (CPCN).

Notes

1. Please consult the most recently issued data sheet before initiating or completing a design.
2. The product status of the device(s) described in this data sheet may have changed since this data sheet was published. The latest information is available on the Internet at URL <http://www.semiconductors.philips.com>.
3. For data sheets describing multiple type numbers, the highest-level product status determines the data sheet status.

DEFINITIONS

Short-form specification — The data in a short-form specification is extracted from a full data sheet with the same type number and title. For detailed information see the relevant data sheet or data handbook.

Limiting values definition — Limiting values given are in accordance with the Absolute Maximum Rating System (IEC 60134). Stress above one or more of the limiting values may cause permanent damage to the device. These are stress ratings only and operation of the device at these or at any other conditions above those given in the Characteristics sections of the specification is not implied. Exposure to limiting values for extended periods may affect device reliability.

Application information — Applications that are described herein for any of these products are for illustrative purposes only. Philips Semiconductors make no representation or warranty that such applications will be suitable for the specified use without further testing or modification.

DISCLAIMERS

Life support applications — These products are not designed for use in life support appliances, devices, or systems where malfunction of these products can reasonably be expected to result in personal injury. Philips Semiconductors customers using or selling these products for use in such applications do so at their own risk and agree to fully indemnify Philips Semiconductors for any damages resulting from such application.

Right to make changes — Philips Semiconductors reserves the right to make changes in the products - including circuits, standard cells, and/or software - described or contained herein in order to improve design and/or performance. When the product is in full production (status 'Production'), relevant changes will be communicated via a Customer Product/Process Change Notification (CPCN). Philips Semiconductors assumes no responsibility or liability for the use of any of these products, conveys no licence or title under any patent, copyright, or mask work right to these products, and makes no representations or warranties that these products are free from patent, copyright, or mask work right infringement, unless otherwise specified.

Philips Semiconductors – a worldwide company

Contact information

For additional information please visit <http://www.semiconductors.philips.com>. Fax: **+31 40 27 24825**

For sales offices addresses send e-mail to: sales.addresses@www.semiconductors.philips.com.

www.DataSheet4U.com

© Koninklijke Philips Electronics N.V. 2004

SCA76

All rights are reserved. Reproduction in whole or in part is prohibited without the prior written consent of the copyright owner.

The information presented in this document does not form part of any quotation or contract, is believed to be accurate and reliable and may be changed without notice. No liability will be accepted by the publisher for any consequence of its use. Publication thereof does not convey nor imply any license under patent- or other industrial or intellectual property rights.

Printed in The Netherlands

R76/01/pp11

Date of release: 2004 Mar 23

Document order number: 9397 750 12255

Let's make things better.

**Philips
Semiconductors**



PHILIPS
www.DataSheet4U.com