

ADM6316/ADM6317/ADM6318/ADM6319/ADM6320/ADM6321/ADM6322

FEATURES

26 reset threshold options:

2.5 V to 5 V in 100 mV increments

4 reset timeout options:

1 ms, 20 ms, 140 ms, and 1120 ms (Min)

4 watchdog timeout options:

6.3 ms, 102 ms, 1600 ms, and 25.6s (Typ)

Manual reset input

Reset output stages:

Push-pull active-low

Open-drain active-low

Push-pull active-high

Low power consumption (3 μ A)

Guaranteed reset output valid to $V_{CC} = 1$ V

Power supply glitch immunity

Specified over industrial temperature range

5-lead SOT-23 package

APPLICATIONS

Microprocessor systems

Computers

Controllers

Intelligent instruments

Portable equipment

GENERAL DESCRIPTION

The ADM6316/ADM6317/ADM6318/ADM6319/ADM6320/ADM6321/ADM6322 are supervisory circuits which monitor power supply voltage levels and code execution integrity in microprocessor-based systems. As well as providing power on reset signals, an on-chip watchdog timer can reset the microprocessor if it fails to strobe within a preset timeout period. A reset signal can also be asserted by means of an external push-button, through a manual reset input. The seven parts feature different combinations of watchdog input, manual reset input and output stage configuration, as shown in Table 1.

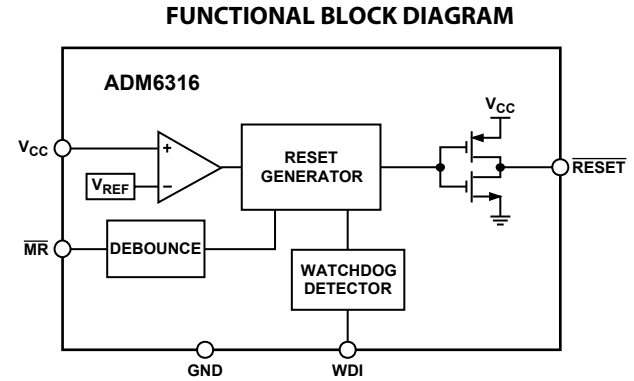

Figure 1.

Each part is available in a choice of 26 reset threshold options ranging from 2.5 V to 5 V in 100 mV increments. There are also four reset timeout options of 1 ms, 20 ms, 140 ms, and 1120 ms (min) and four watchdog timeout options of 6.3 ms, 102 ms, 1600 ms, and 25.6s (typ).

The ADM6316-ADM6322 are available in 5-lead SOT-23 packages and typically consume only 3 μ A, making them suitable for use in low power portable applications.

Table 1. Selection Table

Part No.	Watchdog	Manual Reset	Output Stage	
			RESET	RESET
ADM6316	Yes	Yes	Push-Pull	–
ADM6317	Yes	Yes	–	Push-Pull
ADM6318	Yes	–	Push-Pull	Push-Pull
ADM6319	–	Yes	Push-Pull	Push-Pull
ADM6320	Yes	Yes	Open-Drain	–
ADM6321	Yes	–	Open-Drain	Push-Pull
ADM6322	–	Yes	Open-Drain	Push-Pull

Rev.PrC

Information furnished by Analog Devices is believed to be accurate and reliable. However, no responsibility is assumed by Analog Devices for its use, nor for any infringements of patents or other rights of third parties that may result from its use. Specifications subject to change without notice. No license is granted by implication or otherwise under any patent or patent rights of Analog Devices. Trademarks and registered trademarks are the property of their respective owners.

TABLE OF CONTENTS

Specifications.....	3	Typical Performance Characteristics	7
Absolute Maximum Ratings.....	5	Outline Dimensions	10
ESD Caution.....	5	Ordering Guide	11
Pin Configurations and Function Descriptions	6		

ADM6316/ADM6317/ADM6318/ADM6319/ADM6320/ADM6321/ADM6322

SPECIFICATIONS

V_{CC} = full operating range, T_A = T_{MIN} to T_{MAX} , unless otherwise noted.

Table 2.

Parameter	Min	Typ	Max	Unit	Test Conditions/Comments
SUPPLY					
V_{CC} Operating Voltage Range	1		5.5	V	
Supply Current		10	20	μ A	$V_{CC} = 5.5$ V
		5	12	μ A	$V_{CC} = 3.6$ V
RESET THRESHOLD VOLTAGE					
	$V_{TH} - 1.5\%$	V_{TH}	$V_{TH} + 1.5\%$	V	$T_A = +25^\circ\text{C}$
	$V_{TH} - 2.5\%$	V_{TH}	$V_{TH} + 2.5\%$	V	$T_A = -40^\circ\text{C}$ to $+85^\circ\text{C}$
RESET THRESHOLD TEMPERATURE COEFFICIENT					
		40		ppm/ $^\circ\text{C}$	
RESET THRESHOLD HYSTERESIS					
		3		mV	
RESET TIMEOUT PERIOD					
ADM63__A	1	1.4	2	ms	
ADM63__B	20	28	40	ms	
ADM63__C	140	200	280	ms	
ADM63__D	1120	1600	2240	ms	
V_{CC} TO RESET DELAY					
		40		μ s	V_{CC} falling at 1 mV/ μ s
PUSH-PULL OUTPUT (ADM6316, ADM6317, ADM6318, ADM6319, ADM6321, ADM6322)					
$\overline{\text{RESET}}$ Output Voltage			0.3	V	$V_{CC} > = 1.0$ V, $I_{SINK} = 50$ μ A
			0.3	V	$V_{CC} > = 1.2$ V, $I_{SINK} = 100$ μ A
			0.3	V	$V_{CC} > = 2.7$ V, $I_{SINK} = 1.2$ mA
			0.4	V	$V_{CC} > = 4.5$ V, $I_{SINK} = 3.2$ mA
	$0.8 \times V_{CC}$			V	$V_{CC} > = 2.7$ V, $I_{SOURCE} = 500$ μ A
	$V_{CC} - 1.5$			V	$V_{CC} > = 4.5$ V, $I_{SOURCE} = 800$ μ A
$\overline{\text{RESET}}$ Rise Time		5	25	ns	From 10% to 90% V_{CC} , $C_L = 5$ pF, $V_{CC} = 3.3$ V
RESET Output Voltage			0.3	V	$V_{CC} > = 2.7$ V, $I_{SINK} = 1.2$ mA
			0.4	V	$V_{CC} > = 4.5$ V, $I_{SINK} = 3.2$ mA
	$0.8 \times V_{CC}$			V	$V_{CC} > = 1.8$ V, $I_{SOURCE} = 150$ μ A
	$0.8 \times V_{CC}$			V	$V_{CC} > = 2.7$ V, $I_{SOURCE} = 500$ μ A
	$V_{CC} - 1.5$			V	$V_{CC} > = 4.5$ V, $I_{SOURCE} = 800$ μ A
OPEN-DRAIN OUTPUT (ADM6320, ADM6321, ADM6322)					
$\overline{\text{RESET}}$ Output Voltage			0.3	V	$V_{CC} > = 1.0$ V, $I_{SINK} = 50$ μ A
			0.3	V	$V_{CC} > = 1.2$ V, $I_{SINK} = 100$ μ A
			0.3	V	$V_{CC} > = 2.7$ V, $I_{SINK} = 1.2$ mA
			0.4	V	$V_{CC} > = 4.5$ V, $I_{SINK} = 3.2$ mA
Open-Drain Reset Output Leakage Current			1	μ A	
WATCHDOG INPUT (ADM6316, ADM6317, ADM6318, ADM6320, ADM6321)					
Watchdog Timeout Period	4.3	6.3	9.3	ms	ADM63__W
	71	102	153	ms	ADM63__X
	1.12	1.6	2.4	s	ADM63__Y
	17.9	25.6	38.4	s	ADM63__Z
WDI Pulse Width	50			ns	$V_{IL} = 0.3 \times V_{CC}$, $V_{IH} = 0.7 \times V_{CC}$,

ADM6316/ADM6317/ADM6318/ADM6319/ADM6320/ADM6321/ADM6322

Parameter	Min	Typ	Max	Unit	Test Conditions/Comments
WDI Input Threshold	$0.3 \times V_{CC}$			V	
WDI Input Current		120	$0.7 \times V_{CC}$ 160	V μA	$V_{WDI} = V_{CC}$, time average
	-20	-15		μA	$V_{WDI} = 0$, time average
MANUAL RESET INPUT (ADM6316, ADM6317, ADM6319, ADM6320, ADM6322)					
\overline{MR} Input Threshold	0.8		2.0	V	$V_{TH} > 4.0 V$
				V	$V_{TH} > 4.0 V$
	$0.3 \times V_{CC}$			V	$V_{TH} < 4.0 V$
			$0.7 \times V_{CC}$	V	$V_{TH} < 4.0 V$
\overline{MR} Input Pulse Width	1			μs	
\overline{MR} Glitch Rejection		100		ns	
\overline{MR} Pull-up Resistance	35	52	75	$k\Omega$	
\overline{MR} to Reset Delay		230		ns	$V_{CC} = 5V$

ADM6316/ADM6317/ADM6318/ADM6319/ADM6320/ADM6321/ADM6322

ABSOLUTE MAXIMUM RATINGS

T_A = 25°C, unless otherwise noted.

Table 3.

Parameter	Rating
V _{CC}	-0.3 V to +6 V
$\overline{\text{RESET}}$ (ADM6320, ADM6321, ADM6322)	-0.3 V to +6 V
Output Current (RESET, $\overline{\text{RESET}}$)	20 mA
Operating Temperature Range	-40°C to +85°C
Storage Temperature Range	-65°C to +125°C
θ_{JA} Thermal Impedance, SOT-23	270°C/W
Lead Temperature	
Soldering (10 sec)	300°C
Vapour Phase (60 sec)	215°C
Infrared (15 sec)	220°C

Stresses above those listed under Absolute Maximum Ratings may cause permanent damage to the device. This is a stress rating only and functional operation of the device at these or any other conditions above those indicated in the operational section of this specification is not implied. Exposure to absolute maximum rating conditions for extended periods may affect device reliability.

ESD CAUTION

ESD (electrostatic discharge) sensitive device. Electrostatic charges as high as 4000 V readily accumulate on the human body and test equipment and can discharge without detection. Although this product features proprietary ESD protection circuitry, permanent damage may occur on devices subjected to high energy electrostatic discharges. Therefore, proper ESD precautions are recommended to avoid performance degradation or loss of functionality.



ADM6316/ADM6317/ADM6318/ADM6319/ADM6320/ADM6321/ADM6322

PIN CONFIGURATIONS AND FUNCTION DESCRIPTIONS

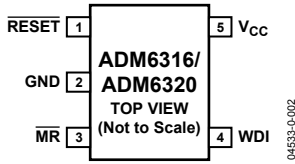

Figure 2. ADM6316/ADM6320 Pin Configuration

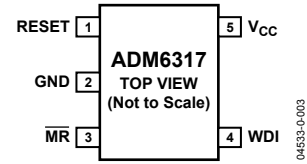

Figure 3. ADM6317 Pin Configuration

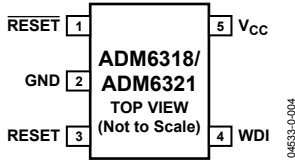

Figure 4. ADM6318/ADM6321 Pin Configuration

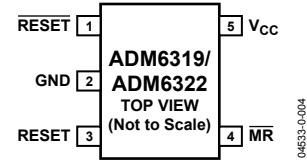

Figure 5. ADM6319/ADM6322 Pin Configuration

Table 4. Pin Function Descriptions

Pin No.	Mnemonic	Description
1	$\overline{\text{RESET}}$ (ADM6316/ADM6318/ ADM6319/ADM6320/ADM6321/ ADM6322) $\overline{\text{RESET}}$ (ADM6317)	Active-Low Reset Output. Asserted whenever V_{CC} is below the reset threshold, V_{TH} . Push-Pull Output Stage for the ADM6316/ADM6318/ADM6319. Open-Drain Output Stage for the ADM6320/ADM6321/ADM6322. Active-High, Push-Pull Reset Output.
2	GND	Ground.
3	$\overline{\text{MR}}$ (ADM6316/ADM6317/ ADM6320) $\overline{\text{RESET}}$ (ADM6318/ADM6319/ ADM6321/ADM6322)	Manual Reset Input. This is an active-low input which, when forced low for at least 1 μs , generates a reset. It features a 52 k Ω internal pull-up. Active-High, Push-Pull Reset Output.
4	WDI (ADM6316/ADM6317/ ADM6318/ADM6320/ADM6321) $\overline{\text{MR}}$ (ADM6319/ADM6322)	Watchdog Input. Generates a reset if the logic level on the pin remains low or high for the duration of the watchdog timeout. The timer is cleared if a logic transition occurs on this pin or if a reset is generated. Leave floating to disable the watchdog timer. Manual Reset Input.
5	V_{CC}	Power Supply Voltage Being Monitored.

TYPICAL PERFORMANCE CHARACTERISTICS

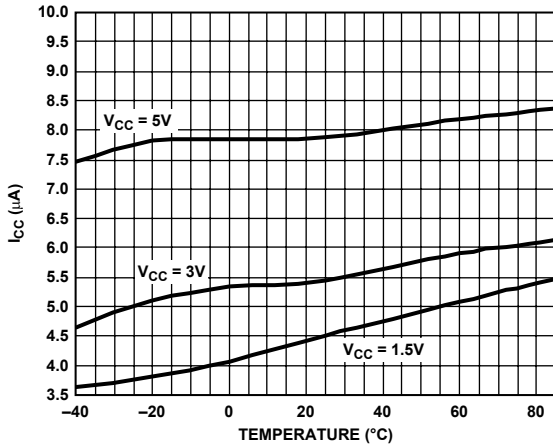

Figure 6. Supply Current vs. Temperature (ADM6316/ADM6317/ADM6318/ADM6320/ADM6321)

04533-0-006

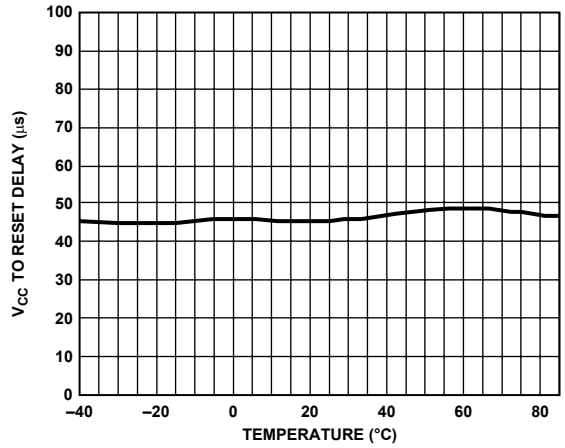

Figure 9. V_{CC} Falling to Reset Propagation Delay vs. Temperature

04533-0-008

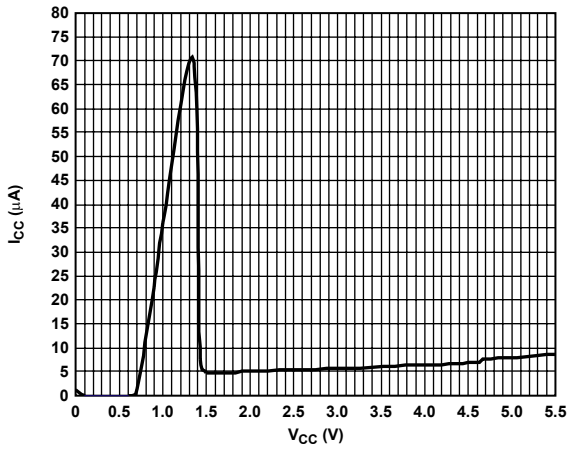

Figure 7. Supply Current vs. Supply Voltage

04533-0-007

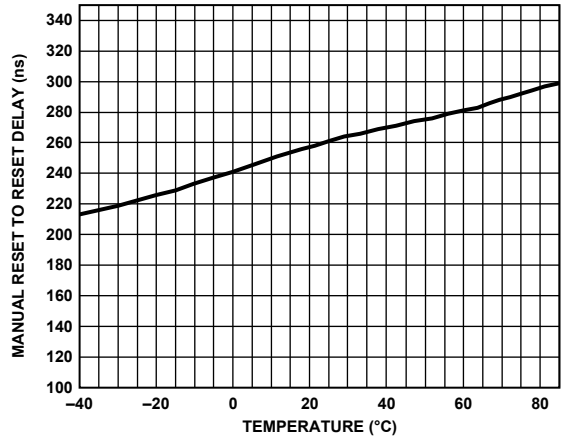

Figure 10. Manual Reset to Reset Propagation Delay vs. Temperature (ADM6316/ADM6317/ADM6319/ADM6320/ADM6322)

04533-0-010

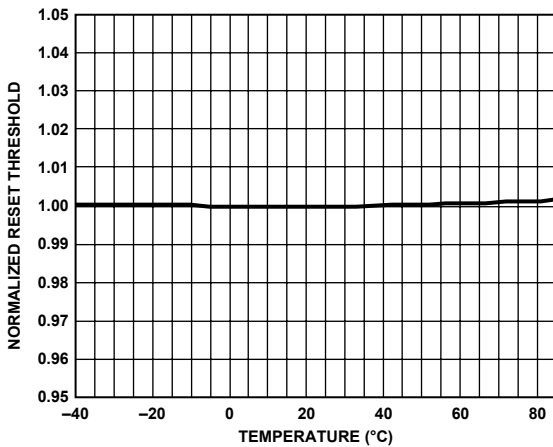

Figure 8. Normalized Reset Threshold vs. Temperature

04533-0-008

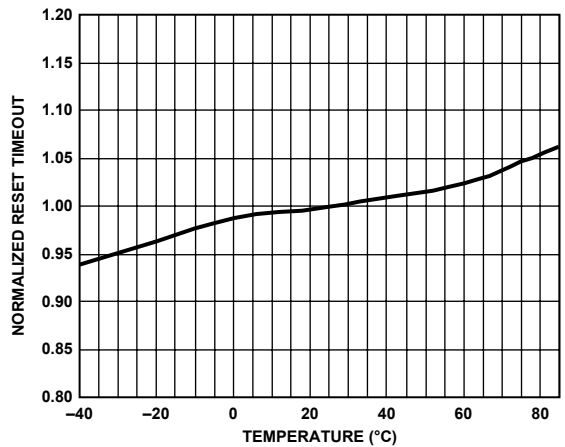
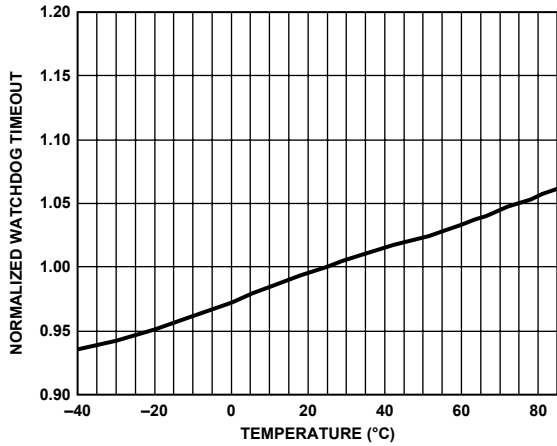

Figure 11. Normalized Reset Timeout Period vs. Temperature

04533-0-011

ADM6316/ADM6317/ADM6318/ADM6319/ADM6320/ADM6321/ADM6322



04533-0-012

Figure 12. Normalized Watchdog Timeout Period vs. Temperature (ADM6316/ADM6317/ADM6318/ADM6320/ADM6321)

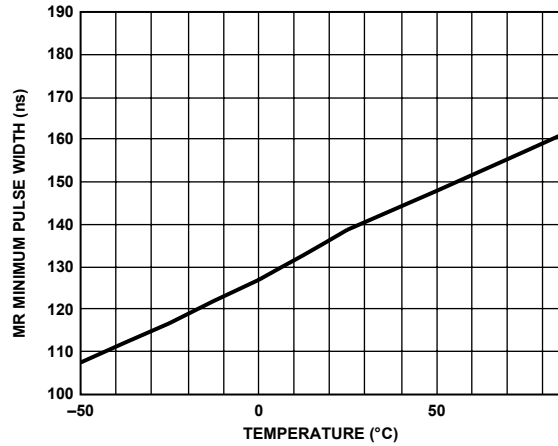

04533-0-014

Figure 14. Manual Reset Minimum Pulse Width vs. Temperature (ADM6316/ADM6317/ADM6319/ADM6320/ADM6322)

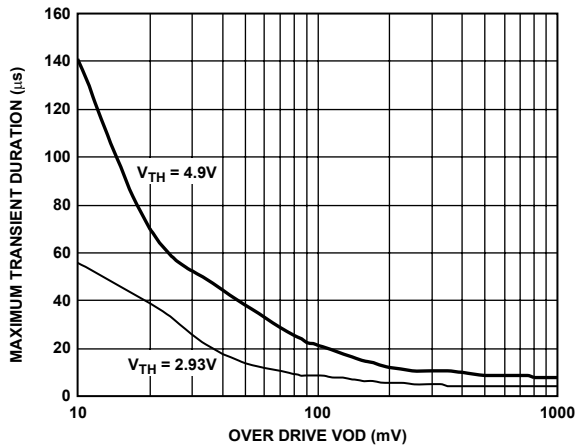

04533-0-013

Figure 13. Maximum V_{CC} Transient Duration vs. Reset Threshold Overdrive

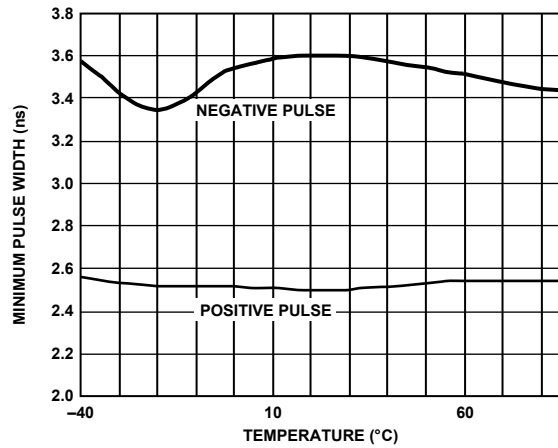

04533-0-015

Figure 15. Watchdog Input Minimum Pulse Width vs. Temperature (ADM6316/ADM6317/ADM6318/ADM6320/ADM6321)

ADM6316/ADM6317/ADM6318/ADM6319/ADM6320/ADM6321/ADM6322

Table 5. Reset Threshold Options

Part No.	T _A = +25°C			T _A = -40°C to +85°C	
	Min	Typ	Max	Min	Max
ADM63 ___ 50	4.925	5.000	5.075	4.875	5.125
ADM63 ___ 49	4.827	4.900	4.974	4.778	5.023
ADM63 ___ 48	4.728	4.800	4.872	4.680	4.920
ADM63 ___ 47	4.630	4.700	4.771	4.583	4.818
ADM63 ___ 46	4.561	4.630	4.699	4.514	4.746
ADM63 ___ 45	4.433	4.500	4.568	4.388	4.613
ADM63 ___ 44	4.314	4.390	4.446	4.270	4.490
ADM63 ___ 43	4.236	4.300	4.365	4.193	4.408
ADM63 ___ 42	4.137	4.200	4.263	4.095	4.305
ADM63 ___ 41	4.039	4.100	4.162	3.998	4.203
ADM63 ___ 40	3.940	4.00	4.060	3.900	4.100
ADM63 ___ 39	3.842	3.900	3.959	3.803	3.998
ADM63 ___ 38	3.743	3.800	3.857	3.705	3.895
ADM63 ___ 37	3.645	3.700	3.756	3.608	3.793
ADM63 ___ 36	3.546	3.600	3.654	3.510	3.690
ADM63 ___ 35	3.448	3.500	3.553	3.413	3.588
ADM63 ___ 34	3.349	3.400	3.451	3.315	3.485
ADM63 ___ 33	3.251	3.300	3.350	3.218	3.383
ADM63 ___ 32	3.152	3.200	3.248	3.120	3.280
ADM63 ___ 31	3.034	3.080	3.126	3.003	3.157
ADM63 ___ 30	2.955	3.000	3.045	2.925	3.075
ADM63 ___ 29	2.886	2.930	2.974	2.857	3.000
ADM63 ___ 28	2.758	2.800	2.842	2.730	2.870
ADM63 ___ 27	2.660	2.700	2.741	2.633	2.768
ADM63 ___ 26	2.591	2.630	2.669	2.564	2.696
ADM63 ___ 25	2.463	2.500	2.538	2.438	2.563

Table 6. Reset Timeout Options

Suffix	Min	Typ	Max	Unit
A	1	1.6	2	ms
B	20	30	40	ms
C	140	200	280	ms
D	1.12	1.60	2.24	s

Table 7. Watchdog Timer Operations

Suffix	Min	Typ	Max	Unit
W	4.3	6.3	9.3	ms
X	71	102	153	ms
Y	1.12	1.6	2.24	s
Z	17.9	25.6	38.4	s

Table 8. Standard Models

Model	Reset Threshold (V)	Minimum Reset Timeout (ms)	Typical Watchdog Timeout (s)
ADM6316CY29ARJ	2.93	140	1.6
ADM6316CY46ARJ	4.63	140	1.6
ADM6318CY46ARJ	4.63	140	1.6
ADM6319C46ARJ	4.63	140	1.6
ADM6320CY29ARJ	2.93	140	1.6
ADM6320CY46ARJ	4.63	140	1.6
ADM6321CY46ARJ	4.63	140	1.6
ADM6322C46ARJ	4.63	140	1.6

OUTLINE DIMENSIONS

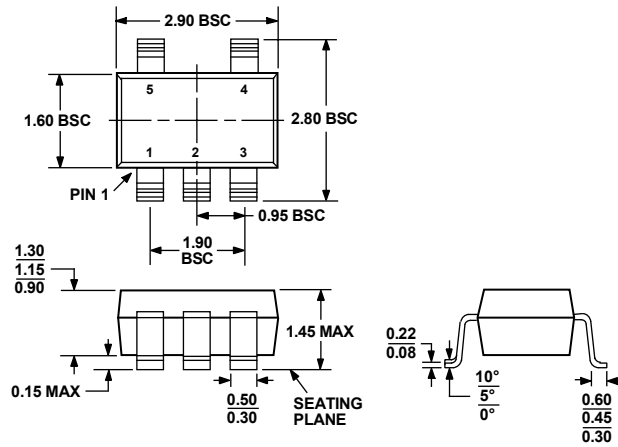

COMPLIANT TO JEDEC STANDARDS MO-178AA

Figure 16. 5-Lead Small Outline Transistor Package [SOT-23] (RJ-5)

Dimensions shown in millimeters

ADM6316/ADM6317/ADM6318/ADM6319/ADM6320/ADM6321/ADM6322

ORDERING GUIDE

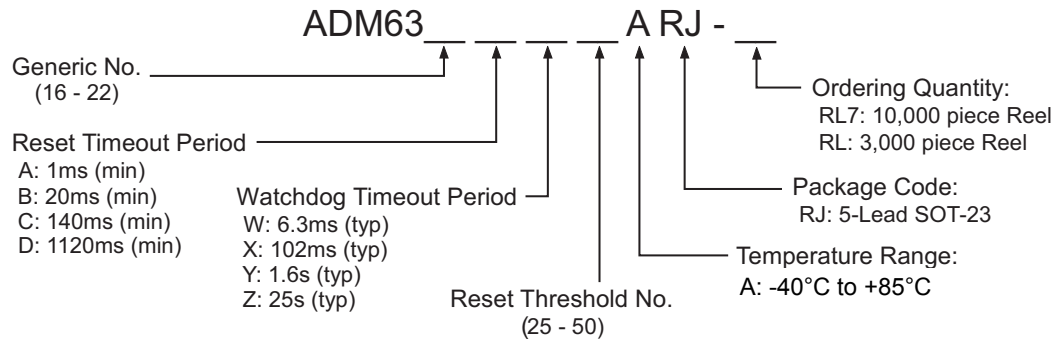

Figure 17. Ordering Code Structure

Model ¹²	Temperature Range	Quantity	Package Option	Branding
ADM6316 ___ ARJ-RL7	-40°C to +85°C	3k	SOT-23-5	N00
ADM6317 ___ ARJ-RL7	-40°C to +85°C	3k	SOT-23-5	N01
ADM6318 ___ ARJ-RL7	-40°C to +85°C	3k	SOT-23-5	N02
ADM6319 ___ ARJ-RL7	-40°C to +85°C	3k	SOT-23-5	N03
ADM6320 ___ ARJ-RL7	-40°C to +85°C	3k	SOT-23-5	N04
ADM6321 ___ ARJ-RL7	-40°C to +85°C	3k	SOT-23-5	N05
ADM6322 ___ ARJ-RL7	-40°C to +85°C	3k	SOT-23-5	N06

¹ Complete the ordering code by inserting reset timeout, watchdog timeout (ADM6316/17/18/20/21) and reset threshold suffixes from tables 5 to 7.

² Contact the factory for the availability of nonstandard models. See Table 8 for a list of standard models.