

### Series 130 - 1206 Duplex

#### Features

- size 1206: 3,2(L) x 1,6(W) x 1,2(H) mm
- circuit substrate: glass laminated epoxy
- soldering pads: gold plated, all soldering methods applicable
- taped in 8 mm blister tape, cathode to transporting perforation
- all devices sorted into luminous intensity classes
- taping: face-up (TU) or face-down (TD) possible
- on request sorted in color classes

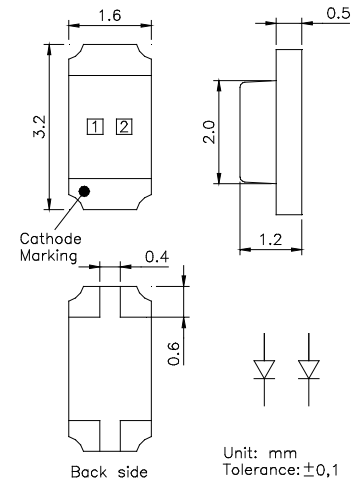

### Absolute Maximum Ratings

$P_{D, max}$ [mW]	$I_{F, P}$ [mA] $tp \leq 100 \mu s$ $\tau=1: 10$	$V_R$ [V]	$I_{R, max}$ [ $\mu A$ ]	Thermal resistance $R_{thJA}$ [K / W]	$T_{Op}$ [ $^{\circ}C$ ]	$T_{St}$ [ $^{\circ}C$ ]
65	100	5	100	450	-40...105	-55...105

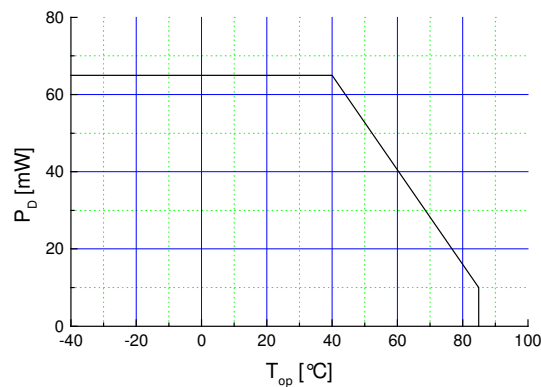

Power reduction characteristic

### Electro-Optical Characteristics

Type	Emission color	Die position	Measurement $I_F$ [mA]	$V_F$ [V]		$\lambda_d / \lambda_p^*$ [nm]	$I_V$ [mcd]	
				typ	max		min	Typ
OLS-130 HSD/HY	hyper TSN red	1	20	2,1	2,6	625	60	120
	hyper yellow	2	20	2,0	2,6	590	60	150

**Outline Drawing**

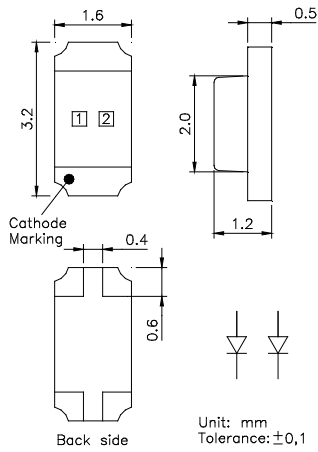

**Recommended Soldering Patterns**

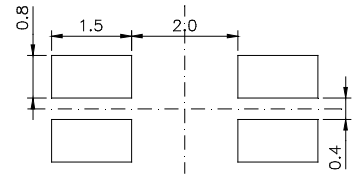

**Soldering Conditions**

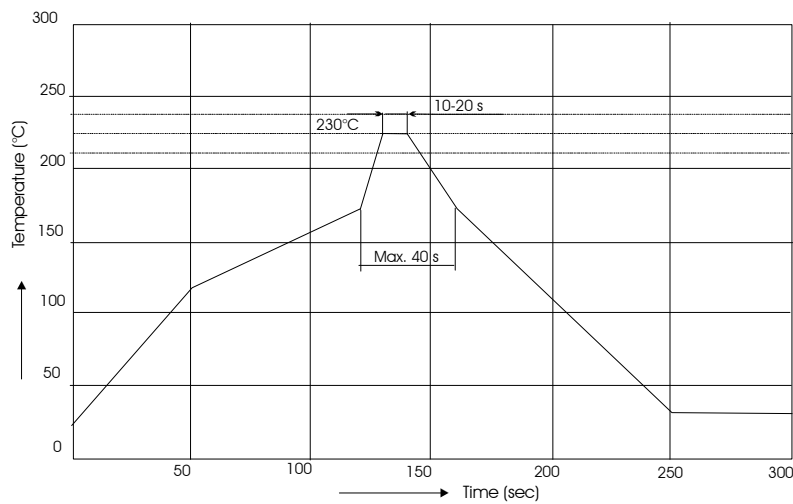

IR reflow soldering profile

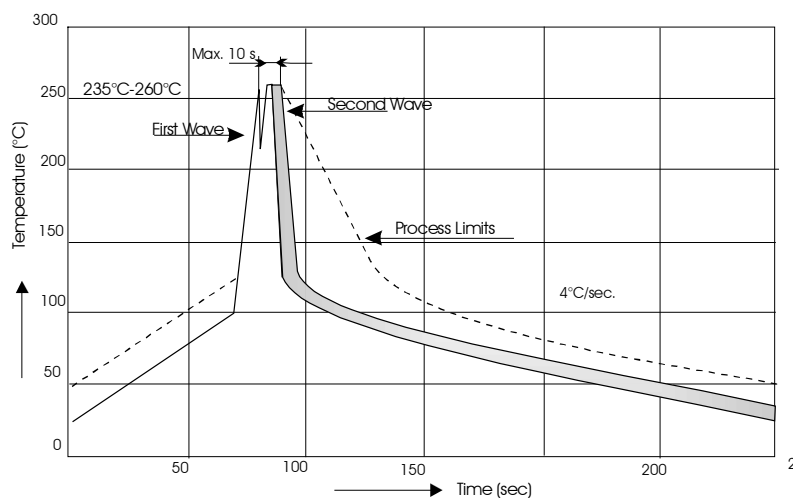

Wave soldering profile

Manual soldering: max power of iron 25W/1s/300 °C

## Ordering Code For Parts

OLS-130 HSD/HY - CX - TU

Type

TU - taped up  
TD - taped down

CX - colored clear

## LED Luminous Intensity Groups And Subgroups [ mcd ]

(general information – not this device specific)

C:	0.28	-	0.45	C1:	0.28	-	0.36	Q1:	71	-	90
D:	0.45	-	0.71	C2:	0.36	-	0.45	Q2:	90	-	112
E:	0.71	-	1.12	D1:	0.45	-	0.56	R1:	112	-	140
F:	1.12	-	1.80	D2:	0.56	-	0.71	R2:	140	-	180
G:	1.80	-	2.80	E1:	0.71	-	0.90	S1:	180	-	224
H:	2.80	-	4.50	E2:	0.90	-	1.12	S2:	224	-	280
J:	4.50	-	7.10	F1:	1.12	-	1.40	T1:	280	-	355
K:	7.10	-	11.20	F2:	1.40	-	1.80	T2:	355	-	450
L:	11.20	-	18.00	G1:	1.80	-	2.24	U1:	450	-	560
				G2:	2.24	-	2.80	U2:	560	-	710
M:	18	-	28	H1:	2.80	-	3.55	V1:	710	-	900
N:	28	-	45	H2:	3.55	-	4.50	V2:	900	-	1120
P:	45	-	71	J1:	4.50	-	5.60	W1:	1120	-	1420
Q:	71	-	112	J2:	5.60	-	7.10	W2:	1420	-	1800
R:	112	-	180	K1:	7.10	-	9.00	X1:	1800	-	2250
S:	180	-	280	K2:	9.00	-	11.20	X2:	2250	-	2800
T:	280	-	450	L1:	11.20	-	14.00	Y1:	2800	-	3550
U:	450	-	710	L2:	14.00	-	18.00	Y2:	3550	-	4500
V:	710	-	1120	M1:	18.00	-	22.40	Z1:	4500	-	5750
W:	1120	-	1800	M2:	22.40	-	28.00	Z2:	5750	-	7100
X:	1800	-	2800	N1:	28.00	-	35.50				
Y:	2800	-	4500	N2:	35.50	-	45.00				
Z:	4500	-	7100	P1:	45.00	-	56.00				
				P2:	56.00	-	71.00				

**Measured according to CIE 127. All SMD-LEDs are 100% measured and selected on full automated equipment with an accuracy of  $\pm 11$  %.**

**Special service: Brightness selection in sub selections possible.  
Color selection in 3 sub selections possible (each subgroup per reel).**

**Tape And Reel Packing**

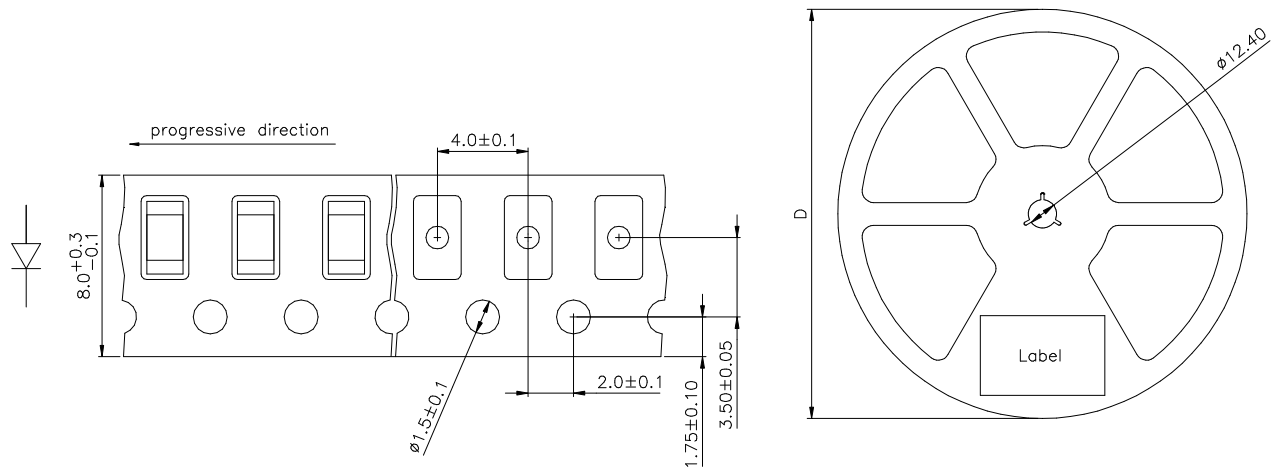

D	Parts/reel
180 mm	3000
330 mm	12000

**Packing:** The reel is sealed in special plastic bag with integrate ESD protection ( MIL - STD 81705 ) including a silica dry-pack

**Label**

Order No.	XXXXXXXXXX	Customer order No.
Type	OLS-130 HSD/HY-??-T?	
Intensity group	ZZ	
Chargen No.	1122-AAAAAA	11 Week – 22 year – A internal identification
Quantity	9999	