

PRELIMINARY
 Notice: This is not a final specification.
 Some parametric limits are subject to change.

MITSUBISHI GATE COMMUTATED TURN-OFF THYRISTORS

FGC3500AX-120DS

HIGH POWER INVERTER USE
 PRESS PACK TYPE

FGC3500AX-120DS



- Asymmetrical GCT
- ITQRM Repetitive controllable on-state current 3500A
- IT(AV) Average on-state current 1200A
- VDRM Repetitive peak off-state voltage 6000V
- VRRM Repetitive peak reverse voltage 21V

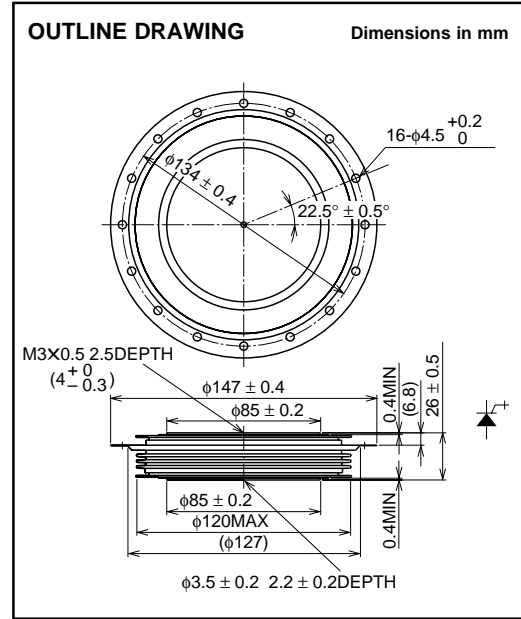

APPLICATION

Inverters, DC choppers, Induction heaters, DC to DC converters.

MAXIMUM RATINGS

Symbol	Parameter	Conditions	Voltage class	Unit
VRRM	Repetitive peak reverse voltage	—	21	V
VRRM	Non-repetitive peak reverse voltage	—	21	V
VDRM	Repetitive peak off-state voltage	VGK = -2V	6000	V
VDSM	Non-repetitive peak off-state voltage	VGK = -2V	6000	V
VLDS	Long term DC stability voltage	VGK = -2V, λ = 100 Fit	3600	V

Symbol	Parameter	Conditions	Ratings	Unit
ITQRM	Repetitive controllable on-state current	VDM = 6000V, VD = 3600V, VRG = 20V diGQ/dt = 6000A/μs, Tj = 25/125°C Cc = 6μF, Lc = 0.3μH (see Fig. 1, 3)	3500	A
IT(RMS)	RMS on-state current	Applied for all conduction angles	1800	A
IT(AV)	Average on-state current	f = 60Hz, sinewave θ = 180°, Tf = 70°C	1200	A
ITSM	Surge on-state current	One half cycle at 60Hz, Tj = 125°C	25	kA
I ² t	Current-squared, time integration		2.6 × 10 ⁶	A ² s
diT/dt	Critical rate of rise of on-state current	VD = 3600V, IT = 3500A, IGM = 200A, Tj = 25/125°C diG/dt = 100A/μs (see Fig. 1, 2)	1000	A/μs
VFGM	Peak forward gate voltage		10	V
VRGM	Peak reverse gate voltage		21	V
IFGM	Peak forward gate current		1000	A
IRGM	Peak reverse gate current		3500	A
PFGM	Peak forward gate power dissipation		10	kW
PRGM	Peak reverse gate power dissipation		120	kW
PFG(AV)	Average forward gate power dissipation		200	W
PRG(AV)	Average reverse gate power dissipation		630	W
Tj	Junction temperature		-20 ~ +125	°C
Tstg	Storage temperature		-20 ~ +150	°C
—	Mounting force required	(Recommended value 40kN)	32 ~ 48	kN
—	Weight	Typical value	1500	g

PRELIMINARY
 Notice: This is not a final specification.
 Some parametric limits are subject to change.

FGC3500AX-120DS

**HIGH POWER INVERTER USE
 PRESS PACK TYPE**

ELECTRICAL CHARACTERISTICS

Symbol	Parameter	Test conditions	Limits			Unit
			Min	Typ	Max	
V _{TM}	On-state voltage	I _T = 3500A, T _j = 125°C	—	—	3.8	V
I _{RRM}	Repetitive peak reverse current	V _{RM} = 21V, T _j = 125°C	—	—	100	mA
I _{DRM}	Repetitive peak off-state current	V _{DM} = 6000V, V _{GK} = -2V, T _j = 125°C	—	—	150	mA
I _{GRM}	Reverse gate current	V _{RG} = 21V, T _j = 125°C	—	—	100	mA
dv/dt	Critical rate of rise of off-state voltage	V _D = 3600V, V _{GK} = -2V, T _j = 125°C (Expo. wave)	3000	—	—	V/μs
t _{gt}	Turn-on time	V _D = 3600V, I _T = 3500A, di/dt = 1000A/μs I _{GM} = 200A, di _G /dt = 100A/μs, T _j = 125°C (see Fig. 1, 2)	—	—	3.0	μs
t _d	Delay time		—	—	1.0	μs
E _{on}	Turn-on switching energy		—	1.2	—	J/P
t _s	Storage time	V _{DM} = 6000V, V _D = 3600V, I _T = 3500A di _{GQ} /dt = 6000A/μs, C _c = 6μF, L _c = 0.3μH V _{RG} = 20V, T _j = 125°C (see Fig. 1, 3)	—	—	3.0	μs
E _{off}	Turn-off switching energy	DC METHOD : V _D = 24V, R _L = 0.1Ω, T _j = 25°C	—	19	—	J/P
I _{GT}	Gate trigger current		—	—	2.5	A
V _{GT}	Gate trigger voltage	—	—	1.5	V	
R _{th(j-f)}	Thermal resistance	Junction to fin	—	—	0.011	K/W

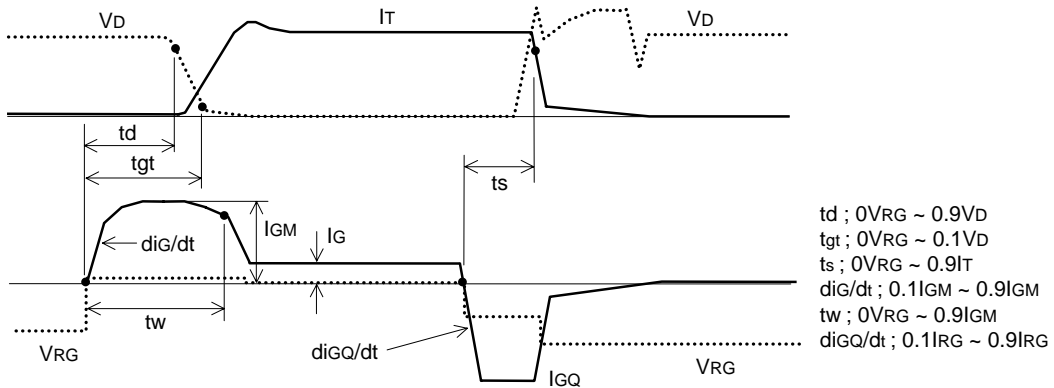

Fig. 1 Turn-on and Turn-off waveform

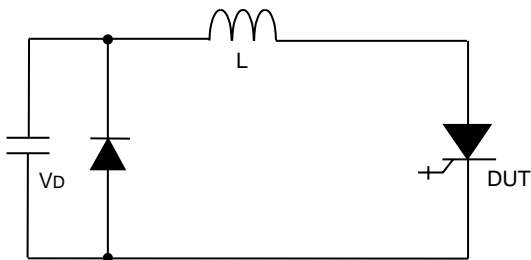
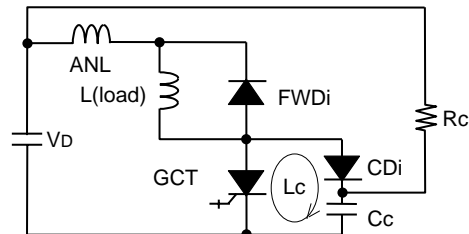

Fig. 2 Turn-on test circuit



**Fig. 3 Turn-off test circuit
 (With clamp circuit)**

PRELIMINARY
 Notice: This is not a final specification.
 Some parametric limits are subject to change.

FGC3500AX-120DS

**HIGH POWER INVERTER USE
 PRESS PACK TYPE**

PERFORMANCE CURVES

MAXIMUM ON-STATE CHARACTERISTIC

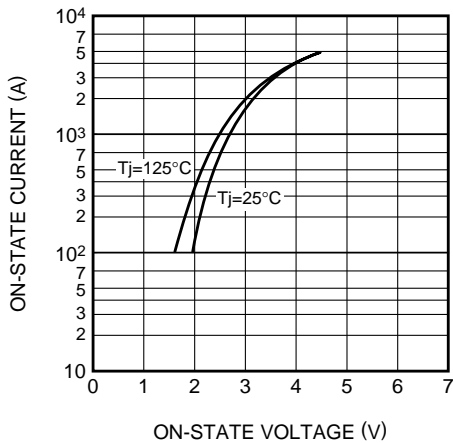

**E_{on} VS I_t
 (TYPICAL)**

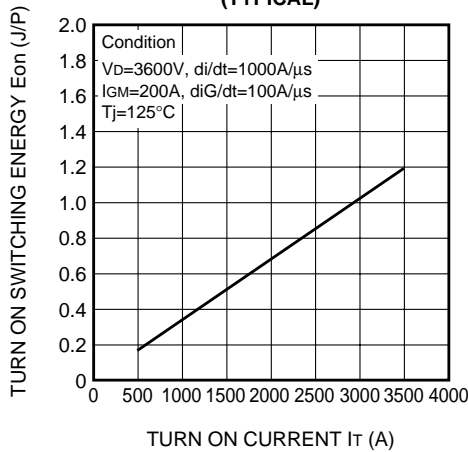

**E_{off} VS I_t
 (TYPICAL)**

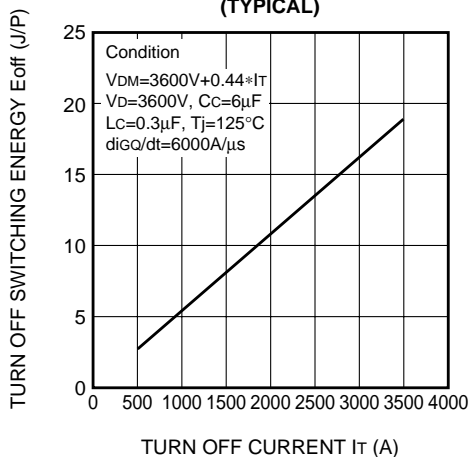

**MAXIMUM THERMAL IMPEDANCE
 CHARACTERISTIC
 (JUNCTION TO FIN)**

