

Features

- Dual Mode Low Drop Out Voltage Regulator
- 1.8V Fixed Output Voltage
- 3V to 5.5V Supply Operation
- 80 mA Maximum Load Current in Full Power Mode
- Maximum Current Consumption 36 μ A in Full Power Mode and 14 μ A in Low Power Mode
- Power-down Mode Consumption Less Than 1 μ A
- More Than 70dB (Typical) PSRR at 1 KHz
- 46 μ V_{RMS} Output Noise
- 0.35 μ m CMOS Technology
- Typical Application: Baseband Memory Section Supply in Mobile Terminals

Description

RE029 is a dual mode Low Drop Out (LDO) voltage regulator macrocell with a fixed 1.8V output voltage, rated for loads up to 80 mA in full power mode and 5 mA in low power mode. (Both modes can be selected by the LP8 signal.) It is designed to be integrated with other analog cells, digital logic, microcontrollers, DSP cores and memory blocks into system-on-chip products.

The circuit consists of a PMOS pass device, an error amplifier and a feedback resistive network, sized to achieve the required closed loop gain. These blocks make up the regulating loop. An over-current and short circuit protection circuit has been included to limit the output current delivered by the regulator, thus avoiding destruction in case of a short circuit.

An external reference voltage V_{BG} (bandgap voltage) is necessary for correct functionality. The target reference voltage is 1.231V delivered, for example, by BG019. Double pads on the supply voltage V_{BAT1B}/V_{BAT1BB} and output voltage V_{MLVA}/V_{MLVAA} are used to reduce the total output resistance. Current reference is generated inside the cell through a circuit supplied by a $2.5V \pm 0.1V$ of regulated input voltage on V_{SAUVC} . Remote sense terminal V_{MLVS} provides regulation of the load by connecting it to the output terminal near a critical point to improve performance of the regulator (e.g., connecting it to the package pin by double-bonding, thus avoiding the bonding resistance influence). A ceramic capacitor of 2.2 μ F connected from V_{MLVA}/V_{MLVAA} to ground is needed as external compensation.

Figure 1. Symbol ⁽¹⁾

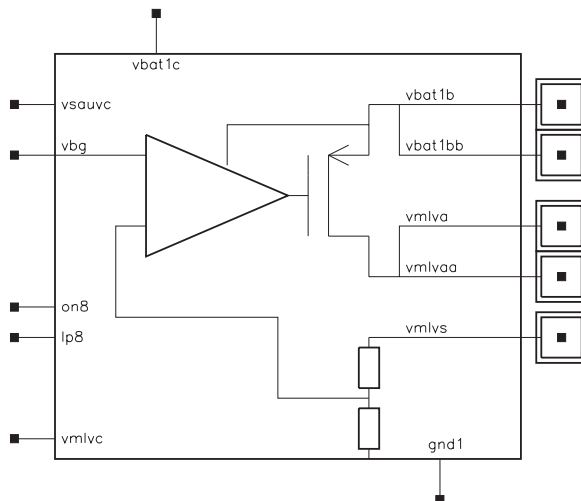

Note: 1. Pin names are written as they appear on the user screen when the symbol is opened in the design tool environment.



**Embedded ASIC
Macrocell:
Power
Management for
Mobile
Terminals (PM)**

**RE029
1.8V 80 mA
Dual Mode LDO
Regulator**



Functional Diagram

Figure 2. Functional Diagram

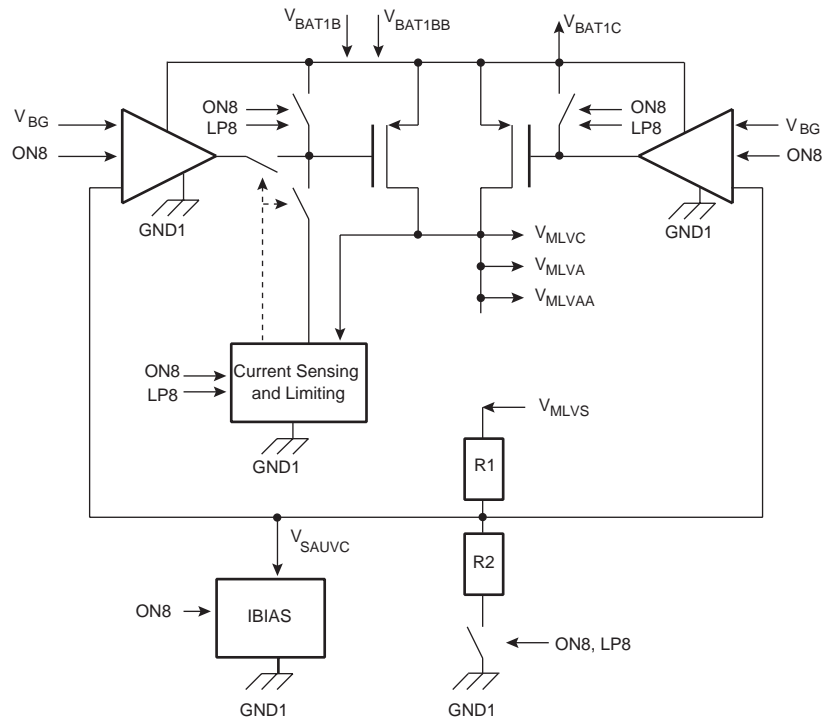

Pin Description

Pin Name	I/O	Type	Function	Value
V _{BAT1B}	Power Supply	External Pad	Power Supply	3V to 5.5V
V _{BAT1BB}	Power Supply	External Pad	Power Supply	3V to 5.5V
V _{MLVA}	Analog Output	External Pad	Output Voltage	1.7V to 1.9V
V _{MLVAA}	Analog Output	External Pad	Output Voltage	1.7V to 1.9V
V _{MLVS}	Analog Input	External Pad	Sense Voltage	1.7V to 1.9V
V _{MLVC}	Analog Output	Internal Pin	Output Voltage	1.7V to 1.9V
V _{BAT1C}	Auxiliary Power Supply	Internal Pin	Power Supply	3V to 5.5V
GND1	Analog Ground	Internal Pin	Ground	0
V _{SAUVc}	Positive Power Supply	Internal Pin	Power Supply	2.5V ± 0.1V
V _{BG}	Analog Input	Internal Pin	Voltage Reference	1.231V
ON8	Digital Input	Internal Pin	Enable Command	0V or V _{BAT1B} /V _{BAT1BB}
LP8	Digital Input	Internal Pin	Low Power Mode Command	0V or V _{BAT1B} /V _{BAT1BB}

RE029 1.8V Dual Mode LDO Regulator

Absolute Maximum Ratings*

Analog Signals	-0.3V to 6.5V
Digital Signals.....	-0.3V to 5.5V
Output Current.....	Internally limited
Junction Temperature	-20°C to 150°C

*NOTICE: Stresses beyond those listed under “Absolute Maximum Ratings” may cause permanent damage to the device. This is a stress rating only and functional operation of the device at these or other conditions beyond those indicated in the operational sections of this specification is not implied. Exposure to absolute maximum rating conditions for extended periods may affect device reliability.

Electrical Specifications⁽¹⁾

$T_J = -20^\circ\text{C}$ to 125°C , $V_{\text{BAT1B}}/V_{\text{BAT1BB}} = 3\text{V}$ to 5.5V unless otherwise specified, output capacitance = $2.2\ \mu\text{F}$.

Table 1. Electrical Characteristics

Symbol	Parameter	Condition	Min	Typ	Max	Unit	
$V_{\text{BAT1B}}/V_{\text{BAT1BB}}$	Operating Supply Voltage		3		5.5	V	
V_{SAUVC}	Auxiliary Operating Supply Voltage		2.4	2.5	2.6	V	
T_J	Temperature Range		-20		125	°C	
Full Power Mode							
$V_{\text{MLVA}}/V_{\text{MLVAA}}$	Output Voltage		1.72		1.87	V	
$I_{\text{MLVA}}/I_{\text{MLVAA}}$	Output Current				80	mA	
I_{QQ}	Quiescent Current		25	30	36	μA	
ΔV_{DC}	Line Regulation	$I_{\text{MLVA}}/I_{\text{MLVAA}} = 80\ \text{mA}$		2	3	mV	
ΔV_{TRAN}	Transient Line Regulation	$I_{\text{MLVA}}/I_{\text{MLVAA}} = 80\ \text{mA}$ rise time = fall time = $5\ \mu\text{s}$		2	3	mV	
ΔV_{DC}	Load Regulation	10% - 90% of max $I_{\text{MLVA}}/I_{\text{MLVAA}}$;		2	4.2	mV	
ΔV_{TRAN}	Transient Load Regulation	10% - 90% of max $I_{\text{MLVA}}/I_{\text{MLVAA}}$; rise time = fall time = $5\ \mu\text{s}$		5	23	mV	
PSRR ⁽²⁾	Power Supply Rejection Ratio at Full Load	$V_{\text{BAT1B}}/V_{\text{BAT1BB}} = 3\text{V}$	@ 100 Hz		-75		dB
			@ 1 kHz		-75		dB
			@ 20 kHz		-55		dB
			@ 100 kHz		-35		dB
		$V_{\text{BAT1B}}/V_{\text{BAT1BB}} = 4.25\text{V}$	@ 100 Hz		-70		dB
			@ 1 kHz		-70		dB
			@ 20 kHz		-60		dB
			@ 100 kHz		-35		dB
		$V_{\text{BAT1B}}/V_{\text{BAT1BB}} = 5.5\text{V}$	@ 100 Hz		-65		dB
			@ 1 kHz		-65		dB
			@ 20 kHz		-55		dB
			@ 100 kHz		-35		dB
V_N	Output Noise ⁽³⁾	Bandwidth = 10 Hz to 100 kHz		46	80	μV _{RMS}	



Table 1. Electrical Characteristics (Continued)

Symbol	Parameter	Condition	Min	Typ	Max	Unit	
T_R	Rise Time	Full Load 10% - 90% of V_{MLVA}/V_{MLVAA}			130	μs	
I_{SD}	Shut Down Current				1	μA	
I_{CC}	Short-circuit Current Threshold				130	mA	
Low Power Mode							
V_{MLVA}/V_{MLVAA}	Output Voltage		1.7		1.9	V	
I_{MLVA}/I_{MLVAA}	Output Current				5	mA	
I_{QQ}	Quiescent Current		9.75	11.5	13.75	μA	
ΔV_{DC}	Line Regulation	$I_{MLVA}/I_{MLVAA} = 5 \text{ mA}$		2	3	mV	
ΔV_{TRAN}	Transient Line Regulation	$I_{MLVA}/I_{MLVAA} = 5 \text{ mA}$ rise time = fall time = 5 μs		2	3	mV	
ΔV_{DC}	Load Regulation	10% - 90% of max I_{MLVA}/I_{MLVAA}		2	5	mV	
ΔV_{TRAN}	Transient Load Regulation	10% - 90% of max I_{MLVA}/I_{MLVAA} ; rise time = fall time = 5 μs		5	8	mV	
PSRR ⁽²⁾	Power Supply Rejection Ratio at Full Load	$V_{BAT1B}/V_{BAT1BB} = 3V$	@ 100 Hz		-70		dB
			@ 1 kHz		-70		dB
			@ 20 kHz		-65		dB
			@ 100 kHz		-35		dB
		$V_{BAT1B}/V_{BAT1BB} = 4.25V$	@ 100 Hz		-65		dB
			@ 1 kHz		-65		dB
			@ 20 kHz		-55		dB
			@ 100 kHz		-35		dB
		$V_{BAT1B}/V_{BAT1BB} = 5.5V$	@ 100 Hz		-45		dB
			@ 1 kHz		-45		dB
			@ 20 kHz		-45		dB
			@ 100 kHz		-40		dB
V_N	Output Noise ⁽³⁾	Bandwidth = 10 Hz to 100 kHz		90	170	μV_{RMS}	
T_R	Rise Time	Full Load 10% - 90% of V_{MLVA}/V_{MLVAA}			170	μs	
I_{SD}	Shut Down Current				1	μA	

- Notes:
1. Obtained by considering the parasitics of a TFBGA100 Package.
 2. This parameter shows the immunization of the circuit taking into account a voltage ripple on battery voltage for different frequencies shown.
 3. Obtained by using BG019 as reference voltage generator.

RE029 1.8V Dual Mode LDO Regulator

Control Modes

All digital signals are referred to the supply voltage V_{BAT1B} , V_{BAT1BB} .

Table 2. Truth Table

ON8	LP8	V_{MLVA}/V_{MLVAA}
0	X	Power down (High-Z)
1	0	Power on, Full Power Mode $V_{MLVA}/V_{MLVAA} = 1.8V$
1	1	Power on, Low Power Mode $V_{MLVA}/V_{MLVAA} = 1.8V$

Application Example

A ceramic capacitor (C_L) of 2.2 μF with ESR between 20 m Ω and 250 m Ω connected from V_{MLVA}/V_{MLVAA} to ground is needed for external compensation.

Description	Min	Typ	Max	Units
Capacitor (C_L)	1.8	2.2	2.6	μF

Figure 3. Application Example

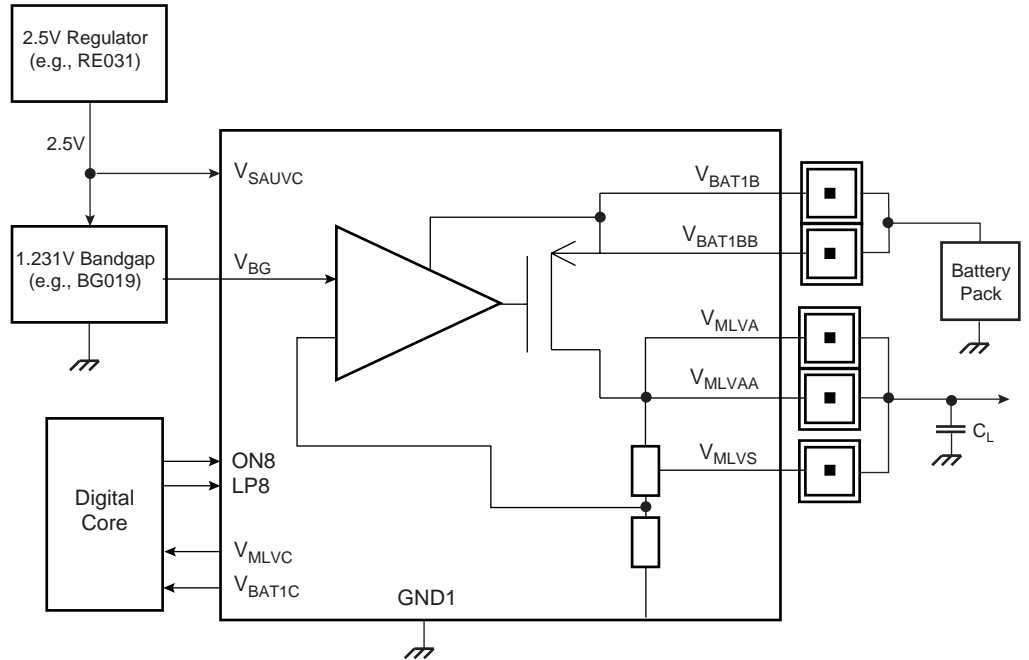

Typical Performance Characteristics (Conditions specified on page 10)

Note.

In these graphs:

- Output Voltage (V_{MLV}) refers to V_{MLVA}/V_{MLVAA}
- Battery Voltage (V_{BAT}) refers to V_{BAT1B}/V_{BAT1BB}
- Output Current (I_{MLV}) refers to I_{MLVA}/I_{MLVAA}

Static Line Regulation at Full Load in Full Power Mode

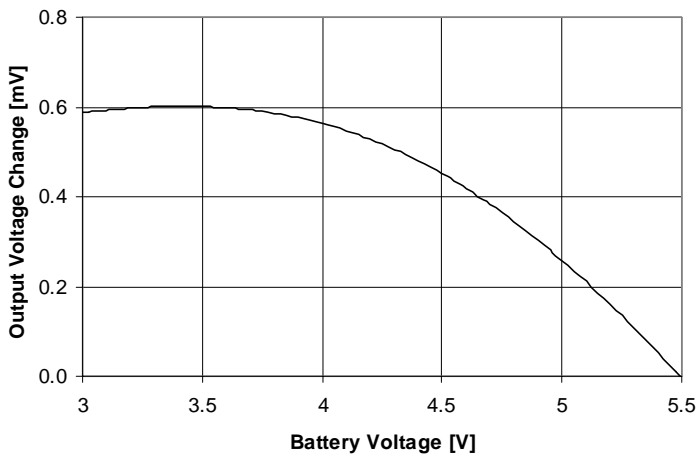

Static Load Regulation in Full Power Mode

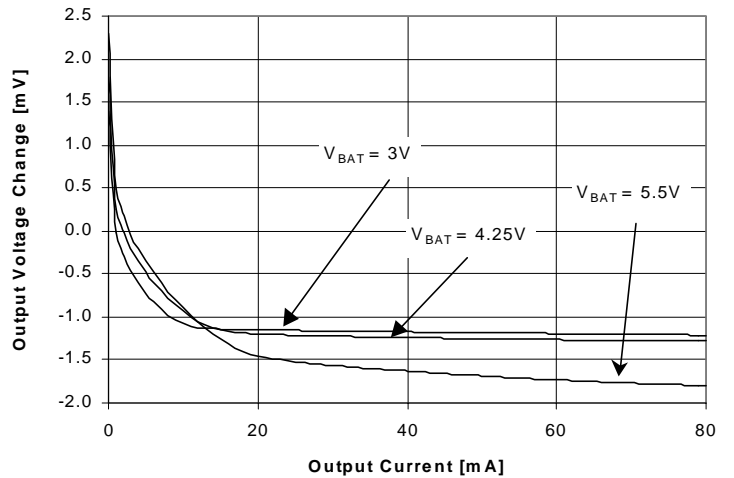

Transient Line Regulation at Full Load in Full Power Mode

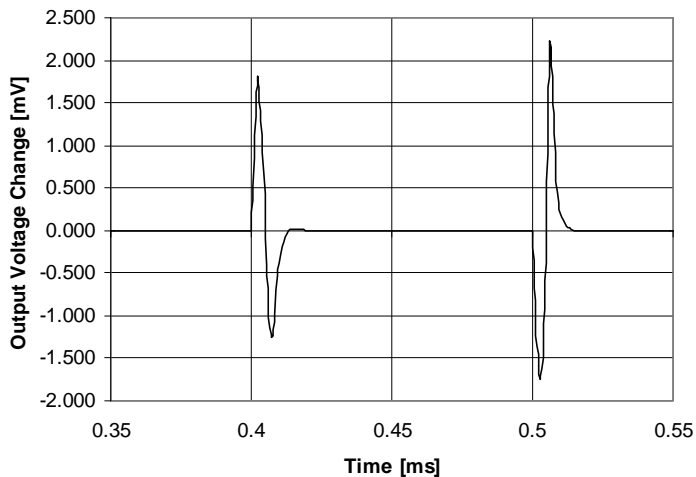

Transient Load Regulation in Full Power Mode

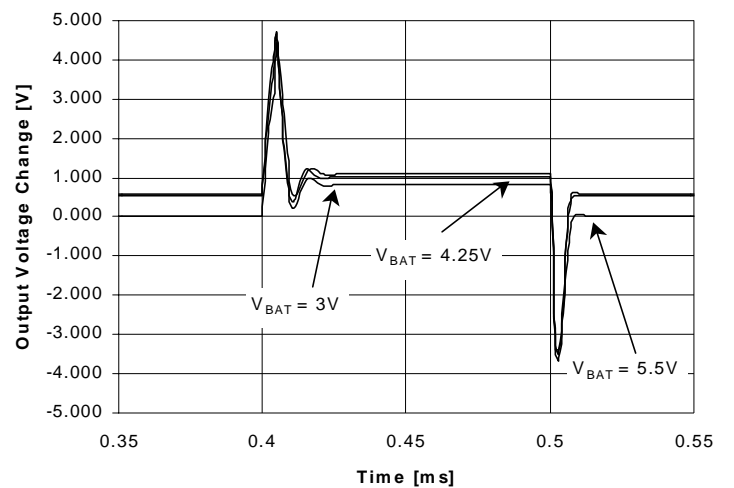

RE029 1.8V Dual Mode LDO Regulator

Typical Performance Characteristics (Conditions specified on page 10)

Power Supply Rejection Ratio at Full Load in Full Power Mode

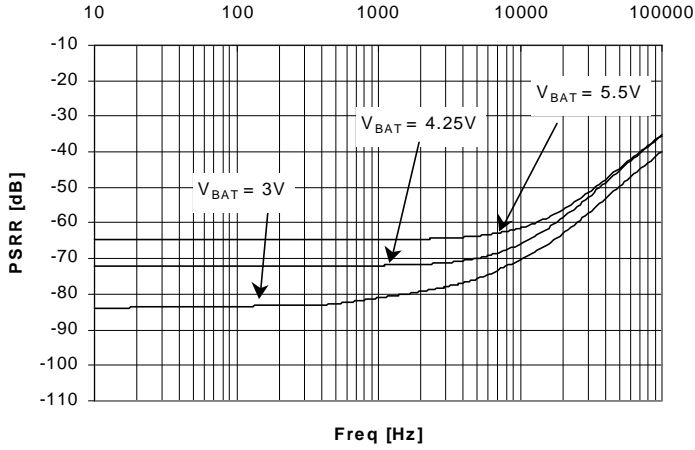

Power Supply Rejection Ratio at Full Load Versus Battery Voltage in Full Power Mode

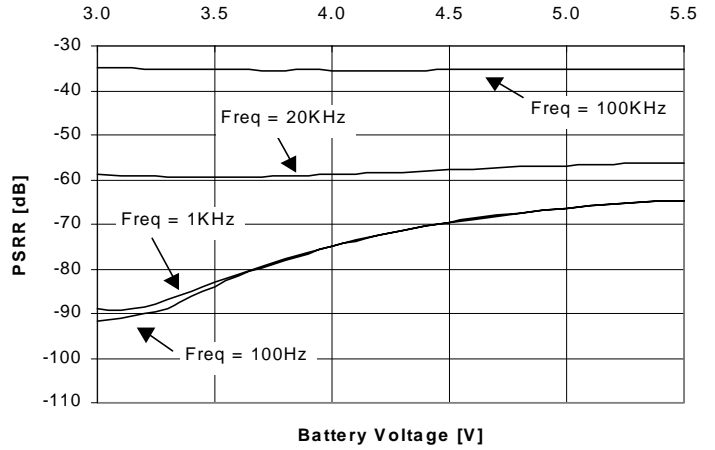

LDO Startup at Full Load for $V_{BAT} = 4.25V$ in Full Power Mode

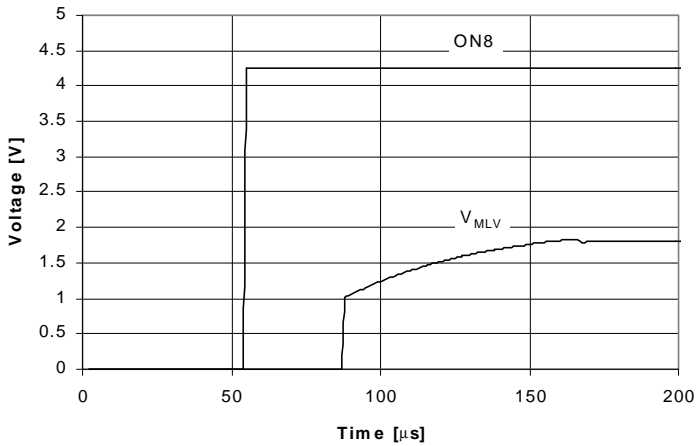

Output Noise Spectrum at Full Load and $V_{BAT} = 4.25V$ in Full Power Mode

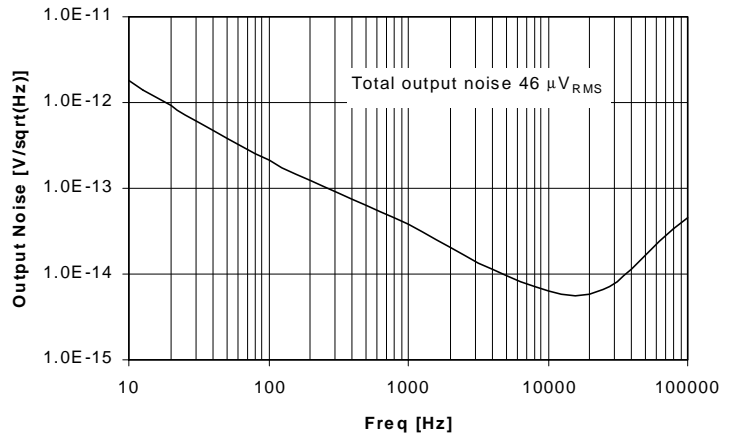

Typical Performance Characteristics (Conditions specified on page 10)

Static Line Regulation at Full Load in Low Power Mode

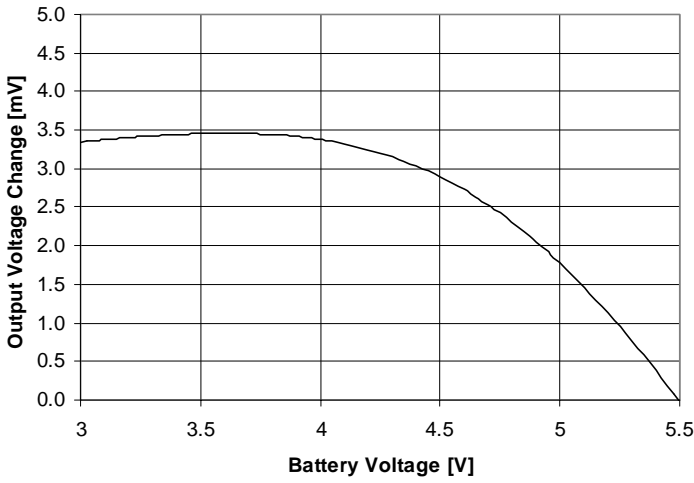

Static Load Regulation in Low Power Mode

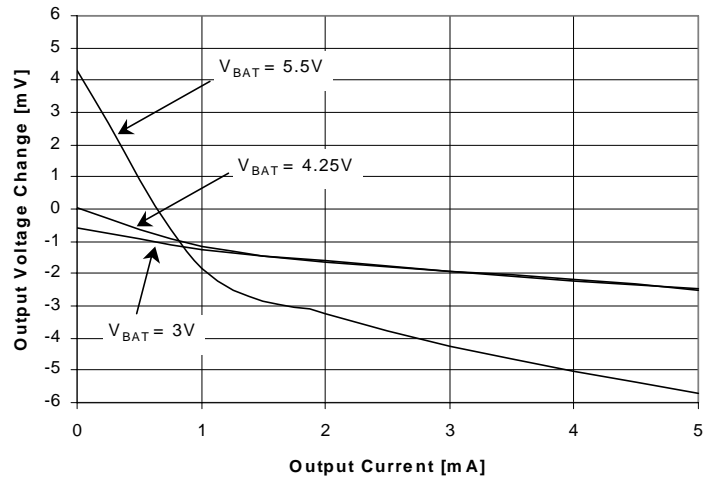

Transient Line Regulation at Full Load in Low Power Mode

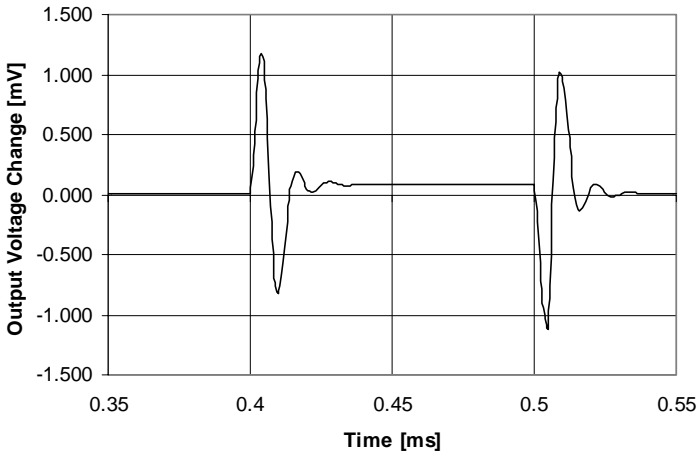

Transient Load Regulation in Low Power Mode

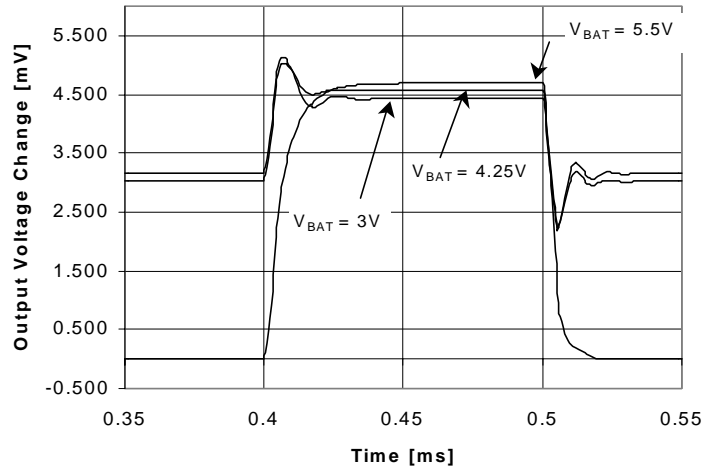

RE029 1.8V Dual Mode LDO Regulator

Typical Performance Characteristics (Conditions specified on page 10)

Power Supply Rejection Ratio at Full Load in Low Power Mode

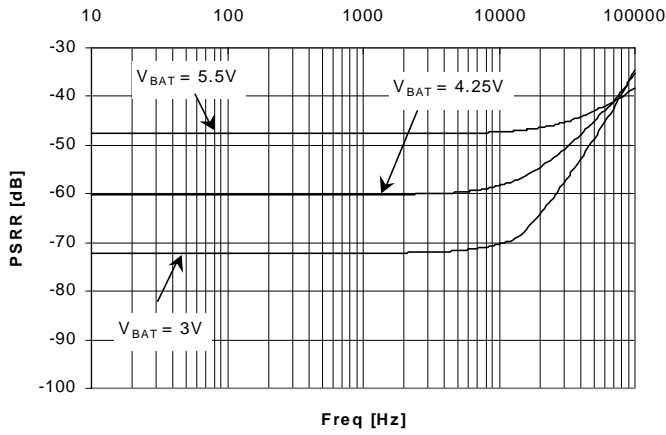

Power Supply Rejection Ratio at Full Load Versus Battery Voltage in Low Power Mode

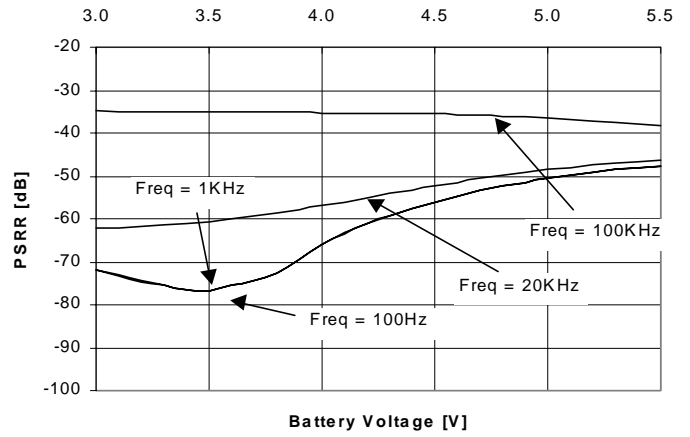

LDO Startup at Full Load for V_{BAT} = 4.25V in Low Power Mode

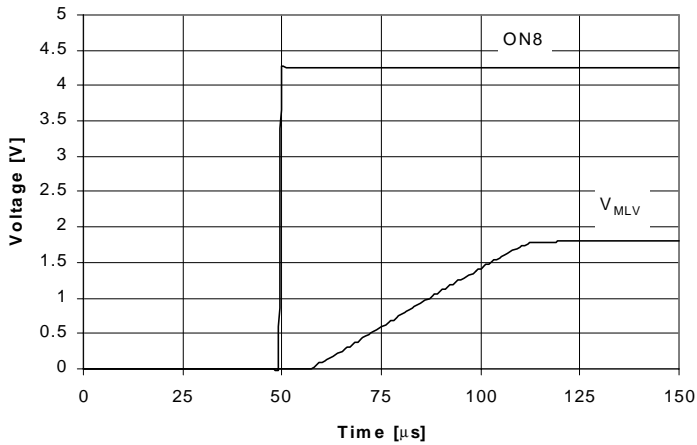

Output Noise Spectrum at Full Load and V_{BAT} = 4.25V in Low Power Mode

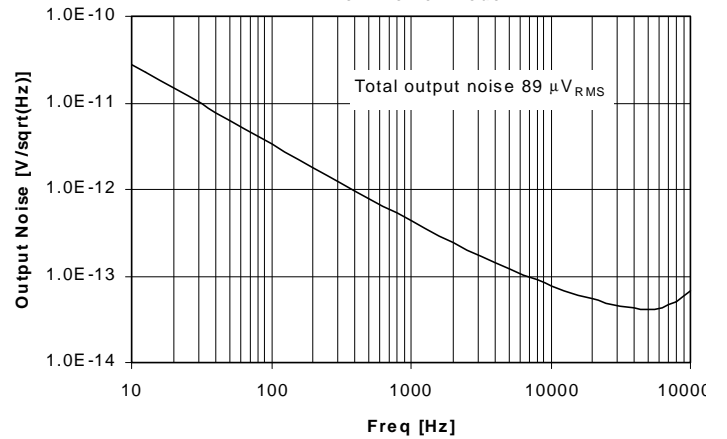

Terminology

Line Regulation

Measures the maximum transient and DC variations of the output voltage of the RE029 when the supply changes between two specified values with fixed load current; minimum rise time and fall time is 5 μ s.

Figure 4. Line Regulation

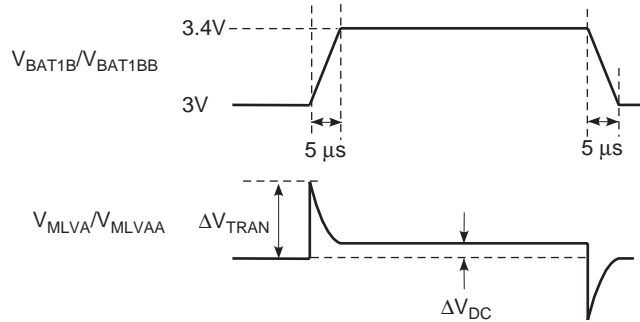

Load Regulation

Measures the maximum transient and DC variations of the output voltage of the RE029 when the load current changes between two specified values with fixed power supply; minimum rise time and fall time is 5 μ s.

Figure 5. Load Regulation

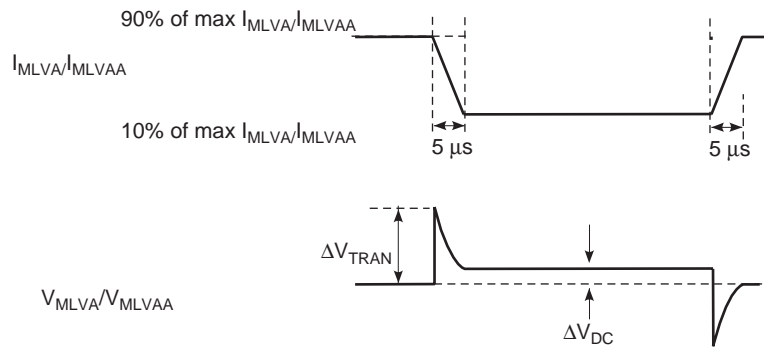



Atmel Headquarters

Corporate Headquarters

2325 Orchard Parkway
San Jose, CA 95131
TEL 1(408) 441-0311
FAX 1(408) 487-2600

Europe

Atmel Sarl
Route des Arsenaux 41
Case Postale 80
CH-1705 Fribourg
Switzerland
TEL (41) 26-426-5555
FAX (41) 26-426-5500

Asia

Room 1219
Chinachem Golden Plaza
77 Mody Road Tsimhatsui
East Kowloon
Hong Kong
TEL (852) 2721-9778
FAX (852) 2722-1369

Japan

9F, Tonetsu Shinkawa Bldg.
1-24-8 Shinkawa
Chuo-ku, Tokyo 104-0033
Japan
TEL (81) 3-3523-3551
FAX (81) 3-3523-7581

Atmel Operations

Memory

2325 Orchard Parkway
San Jose, CA 95131
TEL 1(408) 441-0311
FAX 1(408) 436-4314

Microcontrollers

2325 Orchard Parkway
San Jose, CA 95131
TEL 1(408) 441-0311
FAX 1(408) 436-4314

La Chantrerie
BP 70602
44306 Nantes Cedex 3, France
TEL (33) 2-40-18-18-18
FAX (33) 2-40-18-19-60

ASIC/ASSP/Smart Cards

Zone Industrielle
13106 Rousset Cedex, France
TEL (33) 4-42-53-60-00
FAX (33) 4-42-53-60-01

1150 East Cheyenne Mtn. Blvd.
Colorado Springs, CO 80906
TEL 1(719) 576-3300
FAX 1(719) 540-1759

Scottish Enterprise Technology Park
Maxwell Building
East Kilbride G75 0QR, Scotland
TEL (44) 1355-803-000
FAX (44) 1355-242-743

RF/Automotive

Theresienstrasse 2
Postfach 3535
74025 Heilbronn, Germany
TEL (49) 71-31-67-0
FAX (49) 71-31-67-2340

1150 East Cheyenne Mtn. Blvd.
Colorado Springs, CO 80906
TEL 1(719) 576-3300
FAX 1(719) 540-1759

Biometrics/Imaging/Hi-Rel MPU/ High Speed Converters/RF Datacom

Avenue de Rochepleine
BP 123
38521 Saint-Egreve Cedex, France
TEL (33) 4-76-58-30-00
FAX (33) 4-76-58-34-80

e-mail

literature@atmel.com

Web Site

<http://www.atmel.com>

© Atmel Corporation 2003.

Atmel Corporation makes no warranty for the use of its products, other than those expressly contained in the Company's standard warranty which is detailed in Atmel's Terms and Conditions located on the Company's web site. The Company assumes no responsibility for any errors which may appear in this document, reserves the right to change devices or specifications detailed herein at any time without notice, and does not make any commitment to update the information contained herein. No licenses to patents or other intellectual property of Atmel are granted by the Company in connection with the sale of Atmel products, expressly or by implication. Atmel's products are not authorized for use as critical components in life support devices or systems.

ATMEL®, the Atmel logo and combinations thereof are registered trademarks of Atmel Corporation or its subsidiaries.

Other terms and product names may be the trademark of others.



Printed on recycled paper.