

# 10V Drive Nch MOSFET

## R5011ANX

### ●Structure

Silicon N-channel MOSFET

### ●Features

- 1) Low on-resistance.
- 2) Fast switching speed.
- 3) Gate-source voltage ( $V_{GS}$ ) guaranteed to be  $\pm 30V$ .
- 4) Drive circuits can be simple.
- 5) Parallel use is easy.

### ●Dimensions (Unit : mm)

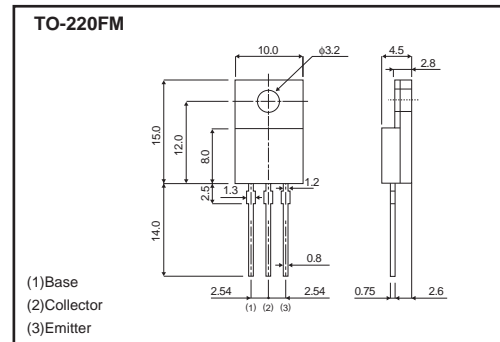

### ●Applications

Switching

### ●Packaging specifications

Type	Package	Bulk
	Code	-
	Basic ordering unit (pieces)	500
R5011ANX		○

### ●Inner circuit

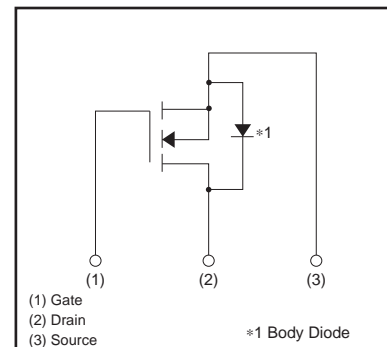

### ●Absolute maximum ratings ( $T_a=25^\circ C$ )

Parameter	Symbol	Limits	Unit	
Drain-source voltage	$V_{DS}$	500	V	
Gate-source voltage	$V_{GS}$	$\pm 30$	V	
Drain current	Continuous	$I_D$ *3	$\pm 11$	A
	Pulsed	$I_{DP}$ *1	$\pm 44$	A
Source current (Body Diode)	Continuous	$I_S$ *3	11	A
	Pulsed	$I_{SP}$ *1	44	A
Avalanche Current	$I_{AS}$ *2	5.5	A	
Avalanche Energy	$E_{AS}$ *2	8.1	mJ	
Total power dissipation ( $T_c=25^\circ C$ )	$P_D$	50	W	
Channel temperature	$T_{ch}$	150	$^\circ C$	
Range of storage temperature	$T_{stg}$	-55 to +150	$^\circ C$	

\*1  $P_w \leq 10 \mu s$ , Duty cycle  $\leq 1\%$

\*2  $L = 500 \mu H$ ,  $V_{DD} = 50V$ ,  $R_G = 25 \Omega$ , Starting,  $T_{ch} = 25^\circ C$

\*3 Limited only by maximum temperature allowed

## Transistors

## ● Thermal resistance

Parameter	Symbol	Limits	Unit
Channel to case	Rth(ch-c)	2.5	°C/W

## ● Electrical characteristics (Ta=25°C)

Parameter	Symbol	Min.	Typ.	Max.	Unit	Conditions
Gate-source leakage	I <sub>GSS</sub>	–	–	±100	nA	V <sub>GS</sub> =±30V, V <sub>DS</sub> =0V
Drain-source breakdown voltage	V <sub>(BR)DSS</sub>	500	–	–	V	I <sub>D</sub> =1mA, V <sub>GS</sub> =0V
Zero gate voltage drain current	I <sub>DSS</sub>	–	–	100	μA	V <sub>DS</sub> =500V, V <sub>GS</sub> =0V
Gate threshold voltage	V <sub>GS(th)</sub>	2.5	–	4.5	V	V <sub>DS</sub> =10V, I <sub>D</sub> =1mA
Static drain-source on-state resistance	R <sub>DS(on)</sub> *	–	0.38	0.5	Ω	I <sub>D</sub> =5.5A, V <sub>GS</sub> =10V
Forward transfer admittance	Y <sub>fs</sub>  *	3.5	–	–	S	I <sub>D</sub> =5.5A, V <sub>DS</sub> =10V
Input capacitance	C <sub>iss</sub>	–	1000	–	pF	V <sub>DS</sub> =25V
Output capacitance	C <sub>oss</sub>	–	400	–	pF	V <sub>GS</sub> =0V
Reverse transfer capacitance	C <sub>rss</sub>	–	35	–	pF	f=1MHz
Turn-on delay time	t <sub>d(on)</sub> *	–	26	–	ns	I <sub>D</sub> =5.5A, V <sub>DD</sub> ≒250V
Rise time	t <sub>r</sub> *	–	28	–	ns	V <sub>GS</sub> =10V
Turn-off delay time	t <sub>d(off)</sub> *	–	75	–	ns	R <sub>L</sub> =45.5Ω
Fall time	t <sub>f</sub> *	–	30	–	ns	R <sub>G</sub> =10Ω
Total gate charge	Q <sub>g</sub> *	–	30	–	nC	V <sub>DD</sub> ≒250V I <sub>D</sub> =11A
Gate-source charge	Q <sub>gs</sub> *	–	7	–	nC	V <sub>GS</sub> =10V
Gate-drain charge	Q <sub>gd</sub> *	–	12	–	nC	R <sub>L</sub> =22.7Ω / R <sub>G</sub> =10Ω

\* Pulsed

## ● Body diode characteristics (Source-drain) (Ta=25°C)

Parameter	Symbol	Min.	Typ.	Max.	Unit	Conditions
Forward voltage	V <sub>SD</sub> *	–	–	1.5	V	I <sub>S</sub> = 11A, V <sub>GS</sub> =0V

\* Pulsed

Transistors

●Electrical characteristic curves

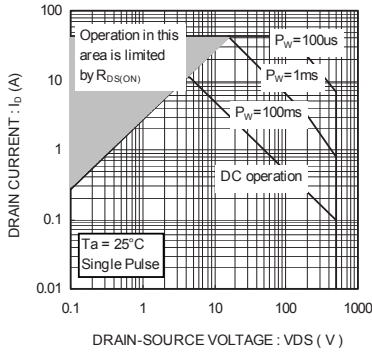

Fig.1 Maximum Safe Operating Area

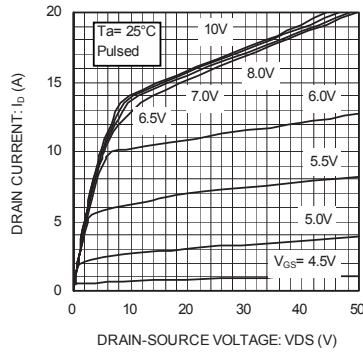

Fig.2 Typical Output Characteristics( I )

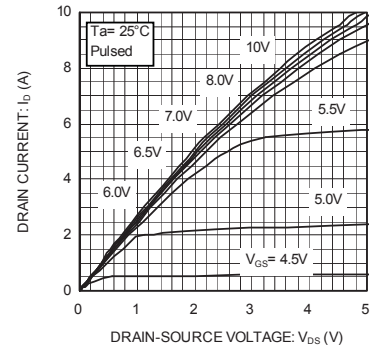

Fig.3: Typical Output Characteristics( II )

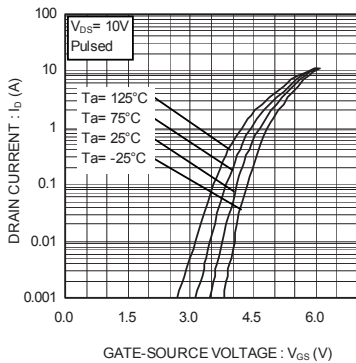

Fig.4 Typical Transfer Characteristics

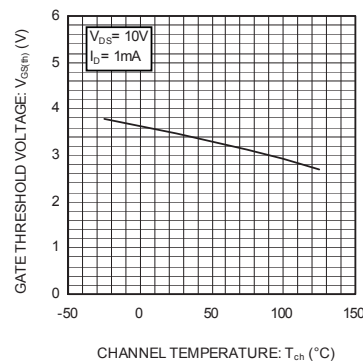

Fig.5 Gate Threshold Voltage vs. Channel Temperature

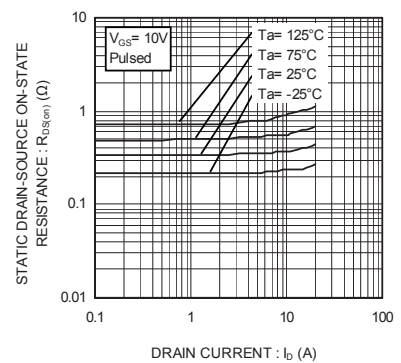

Fig.6 Static Drain-Source On-State Resistance vs. Drain Current

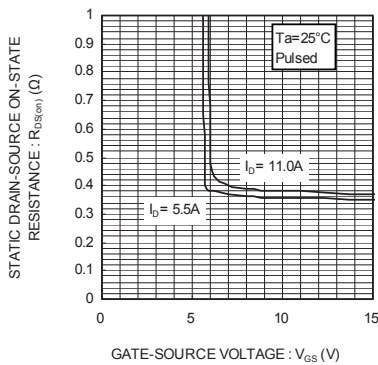

Fig.7 Static Drain-Source On-State Resistance vs. Gate Source Voltage

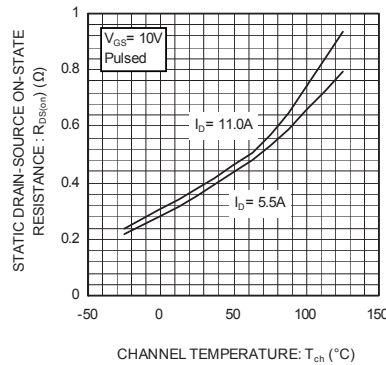

Fig.8 Static Drain-Source On-State Resistance vs. Channel Temperature

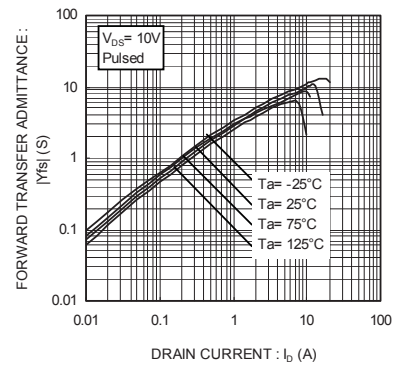

Fig.9 Forward Transfer Admittance vs. Drain Current

Transistors

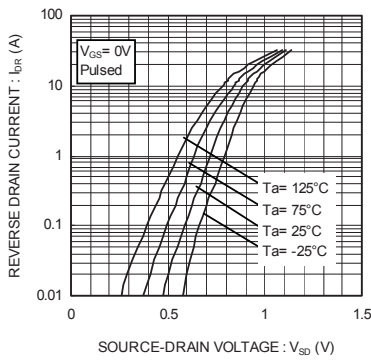

Fig. 10 Reverse Drain Current vs. Source-Drain Voltage

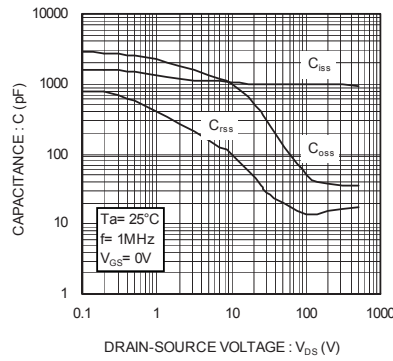

Fig. 11 Typical Capacitance vs. Drain-Source Voltage

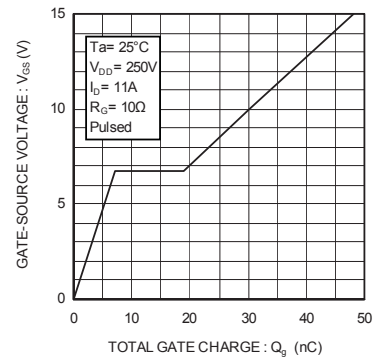

Fig. 12 Dynamic Input Characteristics

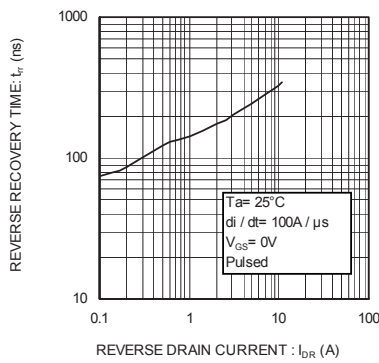

Fig. 13 Reverse Recovery Time vs. Reverse Drain Current

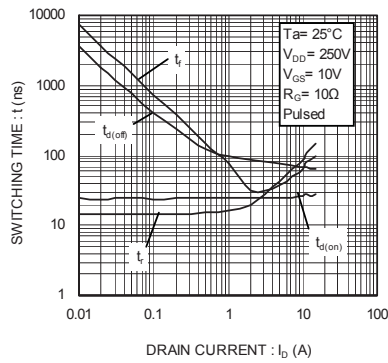

Fig. 14 Switching Characteristics

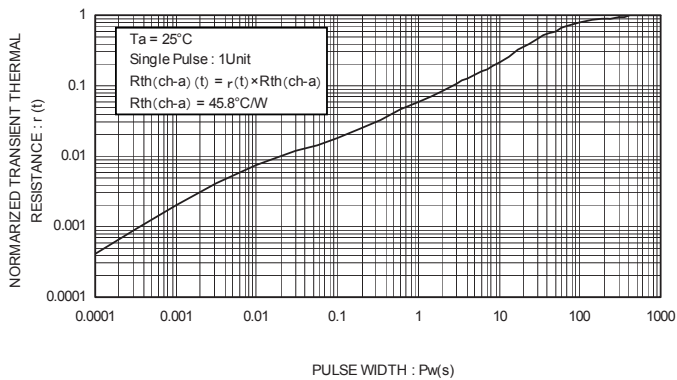

Fig. 15 Normalized Transient Thermal Resistance vs. Pulse Width

Transistors

●Switching characteristics measurement circuit

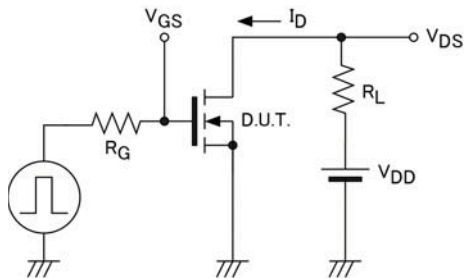

Fig.1-1 Switching Time Measurement Circuit

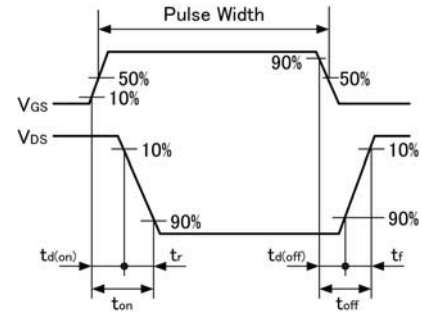

Fig.1-2 Switching Waveforms

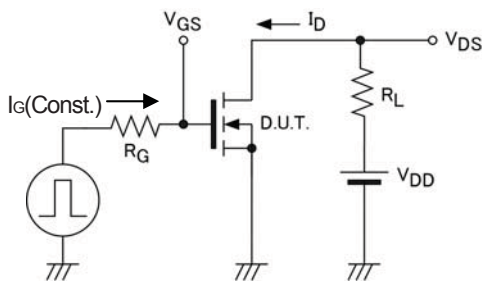

Fig.2-1 Gate Charge Measurement Circuit

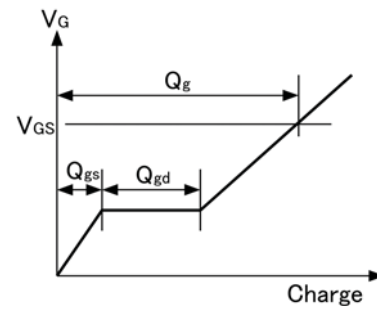

Fig.2-2 Gate Charge Waveform

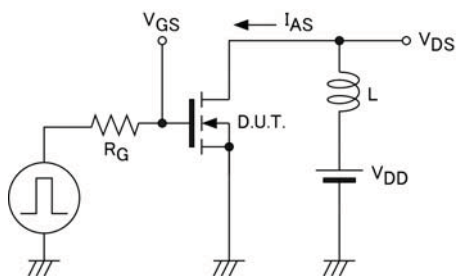

Fig.3-1 Avalanche Measurement Circuit

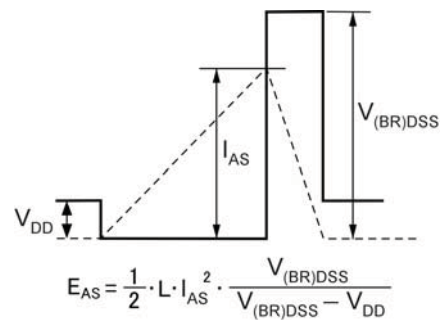

Fig.3-2 Avalanche Waveform

### Notes

- No technical content pages of this document may be reproduced in any form or transmitted by any means without prior permission of ROHM CO.,LTD.
- The contents described herein are subject to change without notice. The specifications for the product described in this document are for reference only. Upon actual use, therefore, please request that specifications to be separately delivered.
- Application circuit diagrams and circuit constants contained herein are shown as examples of standard use and operation. Please pay careful attention to the peripheral conditions when designing circuits and deciding upon circuit constants in the set.
- Any data, including, but not limited to application circuit diagrams information, described herein are intended only as illustrations of such devices and not as the specifications for such devices. ROHM CO.,LTD. disclaims any warranty that any use of such devices shall be free from infringement of any third party's intellectual property rights or other proprietary rights, and further, assumes no liability of whatsoever nature in the event of any such infringement, or arising from or connected with or related to the use of such devices.
- Upon the sale of any such devices, other than for buyer's right to use such devices itself, resell or otherwise dispose of the same, no express or implied right or license to practice or commercially exploit any intellectual property rights or other proprietary rights owned or controlled by
- ROHM CO., LTD. is granted to any such buyer.
- Products listed in this document are no antiradiation design.

The products listed in this document are designed to be used with ordinary electronic equipment or devices (such as audio visual equipment, office-automation equipment, communications devices, electrical appliances and electronic toys).

Should you intend to use these products with equipment or devices which require an extremely high level of reliability and the malfunction of which would directly endanger human life (such as medical instruments, transportation equipment, aerospace machinery, nuclear-reactor controllers, fuel controllers and other safety devices), please be sure to consult with our sales representative in advance.

It is our top priority to supply products with the utmost quality and reliability. However, there is always a chance of failure due to unexpected factors. Therefore, please take into account the derating characteristics and allow for sufficient safety features, such as extra margin, anti-flammability, and fail-safe measures when designing in order to prevent possible accidents that may result in bodily harm or fire caused by component failure. ROHM cannot be held responsible for any damages arising from the use of the products under conditions out of the range of the specifications or due to non-compliance with the NOTES specified in this catalog.

Thank you for your accessing to ROHM product informations.

More detail product informations and catalogs are available, please contact your nearest sales office.

**ROHM** Customer Support System

THE AMERICAS / EUROPE / ASIA / JAPAN

[www.rohm.com](http://www.rohm.com)

Contact us : [webmaster@rohm.co.jp](mailto:webmaster@rohm.co.jp)